

**Quality Assurance Project Plan
Former Fort Ord, California
Volume I, Appendix A**

**Draft Final Revision 9
Groundwater Remedies and Monitoring at Sites 2
and 12, Operable Unit 2, and Operable Unit Carbon
Tetrachloride Plume**



Prepared for:
U.S. Army Corps of Engineers
Sacramento District
1325 J Street
Sacramento, CA 95814-2922



On behalf of:
U.S. Department of the Army
Fort Ord BRAC
4463 Gigling Road, Room 101
Seaside, CA 93955

USACE Contract No. W91238-19-C-0027
Task No. 8



Prepared by:
Ahtna Global, LLC
9699 Blue Larkspur Lane, Suite 201
Monterey, CA 93940-6552

Report Date: **September 2021**
Report Version: **Draft Final**

Table of Contents

Acronyms and Abbreviations	V
1.0 Introduction	1
2.0 Project Management	2
2.1 Worksheets #1 and #2: Title and Approval Page	2
2.2 Worksheets #3 and #5: Project Organization and QAPP Distribution	5
2.3 Worksheets #4, #7, and #8: Personnel Qualifications and Sign-Off Sheet	6
2.4 Worksheet #6: Communication Pathways	9
2.5 Worksheet #9: Project Planning Session Summary	11
3.0 Project Quality Objectives	12
3.1 Worksheet #10: Conceptual Site Model	12
3.1.1 Background and History	12
3.1.2 Sources of Known or Suspected Hazardous Waste	12
3.1.3 Known Contaminants	13
3.1.4 Fate and Transport Considerations	13
3.1.5 Potential Receptors and Exposure Pathways	15
3.1.6 Land Use Considerations	15
3.1.7 Physiography and Topography	16
3.1.8 Geology and Hydrology	16
3.2 Worksheet #11: Project/Data Quality Objectives	18
3.2.1 Step 1: State the Problem	18
3.2.2 Step 2: Identify the Goals of the Study	21
3.2.3 Step 3: Identify Information Inputs	22
3.2.4 Step 4: Define the Boundaries of the Study	23
3.2.5 Step 5: Develop the Analytical Approach	25
3.2.6 Step 6: Specify Performance or Acceptance Criteria	31
3.2.7 Step 7: Develop the Plan for Obtaining Data	33
3.3 Worksheet #12: Measurement Performance Criteria	35
3.3.1 Worksheet #12a: VOCs - Sites 2/12 and OU2 GWTS and Sites 2/12, OU2, and OUCTP GWMP	36
3.3.2 Worksheet #12b: Metals - OU2 GWMP	39
3.3.3 Worksheet #12c: Wet Chemistry - Sites 2/12 GWTS and Sites 2/12 GWMP	41
3.4 Worksheet #13: Secondary Data Uses and Limitations	43
3.5 Worksheets #14 and #16: Project Tasks & Schedule	44
3.5.1 Project Tasks	44
3.5.2 Waste and Equipment Decontamination	44
3.5.3 Quality Control Tasks	44
3.5.4 Secondary Data	44
3.5.5 Data Management Tasks	44
3.5.6 Sample Tracking	44
3.5.7 Data Types	45
3.5.8 Data Tracking and Management	45
3.5.9 Computer Database	45
3.5.10 Geographic Information System Description	46
3.5.11 Data Management Documentation	46

3.5.12	Presentation of Data	47
3.5.13	Assessment and Audit Tasks	47
3.5.14	Data Review Tasks	47
3.5.15	Documentation and Records.....	47
3.5.16	Project Schedule.....	47
3.6	Worksheet #15: Laboratory-Specific Detection/Quantitation Limits.....	48
3.6.1	Worksheet #15a: VOCs by EPA Method 8260-SIM	48
3.6.2	Worksheet #15b: Ion Chromatography by EPA Method 9056A	50
3.6.3	Worksheet #15c: Dissolved Metals by ICP by EPA Method 6010D.....	51
4.0	Sample Design	52
4.1	Worksheet #17: Sampling Design and Rationale.....	52
4.1.1	Worksheet #17a1: Sites 2/12 GWTS Part I.....	52
4.1.2	Worksheet #17a2: Sites 2/12 GWTS Part II.....	53
4.1.3	Worksheet #17b1: OU2 GWTS Part I	54
4.1.4	Worksheet #17b2: OU2 GWTS Part II	56
4.1.5	Worksheet #17c1: Sites 2/12 GWMP	58
4.1.6	Worksheet #17c2: OU2 GWMP.....	60
4.1.7	Worksheet #17c3: OUCTP A-Aquifer GWMP	65
4.1.8	Worksheet #17c4: OUCTP Upper 180-Foot Aquifer GWMP	69
4.1.9	Worksheet #17c5: OUCTP Lower 180-Foot Aquifer GWMP	71
4.2	Worksheet #18: Sampling Locations and Methods	75
5.0	Sampling Requirements	76
5.1	Worksheets #19 and #30: Sample Container, Preservation, and Hold Times	76
5.2	Worksheet #20: Field Quality Control Summary	77
5.3	Worksheet #21: Field SOPs/Methods.....	78
5.4	Worksheet #22: Field Equipment Calibration, Maintenance, Testing, and Inspection	79
6.0	Analytical Requirements	80
6.1	Worksheet #23: Analytical SOPs.....	80
6.2	Worksheet #24: Analytical Instrument Calibration	81
6.3	Worksheet #25: Analytical Instrument and Equipment Maintenance, Testing and Inspection	85
6.4	Worksheets #26 and #27: Sample Handling, Custody, and Disposal.....	86
6.5	Worksheet #28: Analytical Quality Control and Corrective Action	87
6.5.1	Worksheet #28a: VOCs.....	87
6.5.2	Worksheet #28b: Metals.....	90
6.5.3	Worksheet #28c: Wet Chemistry	92
7.0	Data Management and Data Review.....	93
7.1	Worksheet #29: Project Documentation and Records	93
7.1.1	Sample Collection and Field Measurement Records	93
7.1.2	Analytical Records	95
7.1.3	Project Data Assessment Records.....	95
7.2	Worksheets #31, #32, and #33: Assessments and Corrective Action.....	96
7.2.1	Assessments and Corrective Action	97
7.2.2	QA Management	100

7.3	Worksheet #34: Data Verification and Validation Inputs	102
7.4	Worksheet #35: Data Verification Procedures	104
7.5	Worksheet #36: Data Validation Procedures	106
7.5.1	Stage 1 Validation.....	Error! Bookmark not defined.
7.5.2	Stage 2A Validation	Error! Bookmark not defined.
7.5.3	Stage 2B Validation	Error! Bookmark not defined.
7.5.4	Stage 3 Validation.....	Error! Bookmark not defined.
7.5.5	Stage 4 Validation.....	Error! Bookmark not defined.
7.6	Worksheet #37: Data Usability Assessment	107
8.0	References	109

Figures

- 1 Former Fort Ord Location Map
- 2 Sites 2/12 Groundwater Monitoring Program Sampling Locations
- 3 Sites 2/12 Groundwater Remedy Map
- 4 Sites 2/12 Groundwater Treatment Plant Schematic
- 5 OU2 A-Aquifer Groundwater Monitoring Program Sampling Locations
- 6 OU2 Upper 180-Foot Aquifer Groundwater Monitoring Program Sampling Locations
- 7 OU2 Groundwater Remedy and OUCTP Upper 180-Foot Aquifer Groundwater Remedy Map
- 8 OU2 Groundwater Treatment Plant Schematic
- 9 OUCTP A-Aquifer Groundwater Monitoring Program Sampling Locations
- 10 OUCTP A-Aquifer EISB Groundwater Remedy Deployment Areas
- 11 OUCTP Upper 180-Foot Aquifer Groundwater Monitoring Program Sampling Locations
- 12 OUCTP Lower 180-Foot Aquifer Groundwater Monitoring Program Sampling Locations
- 13 OU2 A-Aquifer Hydraulic Zone Map
- 14 OU2 Upper 180-Foot Aquifer Hydraulic Zone Map
- 15 OUCTP A-Aquifer Hydraulic Zone Map
- 16 OUCTP Upper 180-Foot Aquifer Hydraulic Zone Map
- 17 OUCTP Lower 180-Foot Aquifer Hydraulic Zone Map

Table

- 1 Summary of Existing Monitoring Wells and Samples Collected Annually

Attachments

- A Standard Operating Procedures (SOPs)
- B Field Documentation Forms
- C Three Phase Quality Control Process and Documentation
- D Electronic Data Deliverable File Specifications and Qualifier Tables
- E Analytical Laboratory Certifications
- F Responses to Comments on the Draft QAPP

Acronyms and Abbreviations

%	percent
%D	percent difference/percent drift
°C	degrees Celsius
µg/L	micrograms per liter
1,1-DCA	1,1-dichloroethane
1,1-DCE	1,1-dichloroethene
1,2-DCA	1,2-dichloroethane
1,2-DCE (total)	total 1,2-dichloroethene
1,2-DCPA	1,2-dichloropropane
1,3-DCPE (total)	total 1,3-dichloropropene
ACL	Aquifer Cleanup Level
ADR	Automated Data Review
AES	Ahtna Engineering Services
Ahtna	Ahtna Global, LLC
Army	U.S. Department of the Army
BCT	BRAC Cleanup Team
BEC	BRAC Environmental Coordinator
BFB	4-bromofluorobenzene
bgs	below ground surface
BRAC	Base Realignment and Closure
CCB	continuing calibration blanks
CCRWQCB	California Regional Water Quality Control Board, Central Coast Region
CCV	continuing calibration verification
CERCLA	Comprehensive Environmental Response, Compensation, and Liability Act
cis-1,2-DCE	cis-1,2-dichloroethene
COC	chemical of concern
COD	coefficient of determination
CQCR	Contractor Quality Control Report
CQM	Construction Quality Management
CPR	cardiopulmonary resuscitation
CRF	Cooler Receipt Form
CT	carbon tetrachloride
DCL	discharge limit
DL	detection limit
DO	dissolved oxygen
DoD	Department of Defense
DQI	data quality indicator
DQO	data quality objective
DTSC	California Department of Toxic Substances Control

Acronyms and Abbreviations (continued)

DTW	depth to water
EDD	electronic data deliverable
EISB	enhanced <i>in situ</i> bioremediation
ELAP	Environmental Laboratory Accreditation Program
EPA	U.S. Environmental Protection Agency
ESD	Explanation of Significant Differences
EW	Extraction Well
FADL	Field Activity Daily Logbook
FODIS	Fort Ord Data Integration System
FO-SVA	Fort Ord-Salinas Valley Aquitard
GAC	granular activated carbon
GC/MS	gas chromatography-mass spectrometry
GIS	geographic information system
GWMP	groundwater monitoring program
GWTP	groundwater treatment plant
GWTS	groundwater treatment system
H&S	health and safety
HACCP	Hazard Analysis & Critical Control Points
HAZWOPER	Hazardous Waste Operations and Emergency Response
HCl	hydrochloric acid
HDPE	high-density polyethylene
HLA	Harding Lawson Associates
HNO ₃	nitric acid
IC	ion chromatography
ICAL	initial calibration
ICP	inductively coupled plasma
ICS	interference check sample
ICV	initial calibration verification
ID	identification
IDQTF	Intergovernmental Data Quality Task Force
LCS	laboratory control samples
LCSD	LCS duplicate
LOD	limit of detection
LOQ	limit of quantitation
MC	methylene chloride
MCL	maximum contaminant level
MCWD	Marina Coast Water District
MEC	munitions and explosives of concern
mg/L	milligrams per liter
mL	milliliter

Acronyms and Abbreviations (continued)

MNA	monitored natural attenuation
MPC	measurement performance criteria
MS	matrix spike
MSD	matrix spike duplicate
MSL	mean sea level
N/A	not applicable
ND	non-detect
NPL	National Priorities List
O&M	operations and maintenance
ORP	oxidation-reduction potential
OU	operable unit
OU2	Operable Unit 2
OUCTP	Operable Unit Carbon Tetrachloride Plume
PARCCS	precision, accuracy, representativeness, comparability, completeness, sensitivity
Pb	lead
PCE	tetrachloroethene
PDB	passive diffusion bag
PDS	post-digestion spike
PE	registered Professional Engineer
QA	quality assurance
QAPP	Quality Assurance Project Plan
QC	quality control
QSM	Quality Systems Manual
RAWP	Remedial Action Work Plan
RI	Remedial Investigation
RF	response factor
ROD	Record of Decision
RPD	relative percent difference
RSD	relative standard deviation
Sb	antimony
SGS	SGS North America, Inc.
SIM	selected ion monitoring
Sites 2/12	Sites 2 and 12
SM	Standard Methods
SOP	standard operating procedure
SRF	Sample Receipt Forms
TAT	turnaround time
TCE	trichloroethene
trans-1,2-DCE	trans-1,2-dichloroethene
UCL	upper confidence limit

Acronyms and Abbreviations (continued)

USACE	U.S. Army Corps of Engineers
USGS	U.S. Geological Survey
VC	vinyl chloride
VOA	volatile organic analysis
VOC	volatile organic compound

1.0 Introduction

On behalf of the U.S. Army Corps of Engineers (USACE), Sacramento District, Ahtna Global, LLC (Ahtna) updated this Quality Assurance Project Plan (QAPP)¹ under Contract Number W91238-19-C-0027 for response actions to be performed at the former Fort Ord (Figure 1) in accordance with the Comprehensive Environmental Response, Compensation, and Liability Act (CERCLA or “Superfund”) to address historical releases of chemicals of concern (COCs) at the former Fort Ord. The QAPP was updated and revised to:

- Update the number of wells monitored on an annual basis (Table 1), the list of wells sampled (Worksheet #17c) and the sampling location maps (Figures 2, 5, 6, 15, 16, and 17) based on recent progress in remedial actions for groundwater.²
- Reflect recent changes in project personnel.

This QAPP is the governing guidance document for groundwater and treatment system sampling associated with Sites 2 and 12 (Sites 2/12), Operable Unit 2 (OU2), and Operable Unit Carbon Tetrachloride Plume (OUCTP) at the former Fort Ord. This QAPP details quality assurance (QA) and quality control (QC) procedures for sampling and analytical activities performed for the groundwater treatment system (GWTS) and the groundwater monitoring program (GWMP). The QAPP ensures the data generated follow the data quality indicators (DQIs) of precision, accuracy, representativeness, comparability, completeness, and sensitivity (PARCCS parameters), and are of sufficient quality to support project decisions.

¹ This document is Appendix A to the *Quality Assurance Project Plan, Superfund Response Actions, Former Fort Ord, California, Volume I*. Volume I is also the governing document for sampling and analysis of soil (Appendix B), soil gas (Appendix C), and landfill gas (Appendix D). Volume II of the QAPP pertains to the former Fort Ord military munitions response program.

² Presented in the Annual Fourth Quarter 2019 through Third Quarter 2020 reports.

2.0 Project Management

2.1 Worksheets #1 and #2: Title and Approval Page

Site Name/Project Name: Former Fort Ord/Superfund Response Actions

Site Location: Former Fort Ord, California

Document Title: Quality Assurance Project Plan, Former Fort Ord, California, Volume I, Appendix A Draft Revision 9, Groundwater Remedies and Monitoring at Operable Unit 2, Sites 2 and 12, and Operable Unit Carbon Tetrachloride Plume

Lead Organization: U.S. Army Corps of Engineers

Preparer's Name, Organization, and Contact Info: Eric Schmidt, Ahtna
9699 Blue Larkspur Lane, Suite 203, Monterey, CA 93940
(831) 287-5254
eschmidt@ahtna.net

Preparation Date: April 2, 2020

Project Role	Name Organization	Signature	Date
Investigative Organization's Project Manager	Derek Lieberman Ahtna		
Investigative Organization's Project Chemist	Eric Schmidt Ahtna		
Lead Organization's Technical Lead	Bridget Floyd USACE		
Lead Organization's Project Chemist	Jonathan Whipple USACE		

Plans and reports from previous investigations relevant to this project:

Site Name/Project Name: Former Fort Ord/Superfund Response Actions
Site Location: Monterey County, California
Site Number/Code: Not Applicable (N/A)
Operable Units: OU2, OUCTP, and Sites 2/12
Contractor Name: Ahtna Global, LLC
Contract Number: W91238-19-C-0027
Contract Title: Former Fort Ord Basewide Groundwater and Soil Vapor Treatment and Monitoring, Former Fort Ord, California

Work Assignment Number: N/A

Guidance used to prepare QAPP: Uniform Federal Policy for Quality Assurance Project Plans, Optimized UFP-QAPP Worksheets, March 2012, Revision 1. DoD QSM for Environmental Laboratories, Version 5.3, 2019

Regulatory Program: CERCLA as amended by the Superfund Amendment and Reauthorization Act

Approval Entities: U.S. Environmental Protection Agency (EPA), California Department of Toxic Substance Control (DTSC), and Regional Water Quality Control Board, Central Coast Region (CCRWQCB)

Data Users: U.S. Department of the Army (Army), USACE, EPA (and its consultant TechLaw, Inc.), DTSC, CCRWQCB, Army/USACE contractors, citizen groups, and members of the public

Organizational partners (stakeholders) and connection with lead organization: USACE, Army (lead agency/owner), EPA (lead oversight agency), DTSC (support agency), and CCRWQCB (support agency)

The QAPP is (select one): Generic: _____ Project-Specific: X

Dates and titles of QAPP documents written for previous site work:

Title	Approval Date
<i>Quality Assurance Project Plan, Superfund Response Actions, Former Fort Ord, California, Volume I, Groundwater, Appendix A, Final Revision 8</i>	February 2021
<i>Quality Assurance Project Plan, Superfund Response Actions, Former Fort Ord, California, Volume I, Groundwater, Appendix A, Final Revision 7</i>	August 2019
<i>Quality Assurance Project Plan, Superfund Response Actions, Former Fort Ord, California, Volume I, Groundwater, Appendix A, Final Revision 6</i>	March 2018
<i>Quality Assurance Project Plan, Superfund Response Actions, Former Fort Ord, California, Volume I, Groundwater, Appendix A, Final Revision 5</i>	June 2017
<i>Quality Assurance Project Plan, Superfund Response Actions, Former Fort Ord, California, Volume I, Groundwater, Appendix A, Final Revision 4</i>	March 2016
<i>Quality Assurance Project Plan, Superfund Response Actions, Former Fort Ord, California, Volume I, Groundwater, Appendix A, Final Revision 3</i>	June 2015
<i>Quality Assurance Project Plan, Superfund Response Actions, Former Fort Ord, California, Volume I, Groundwater, Appendix A, Final Revision 2</i>	February 2014
<i>Quality Assurance Project Plan, Superfund Response Actions, Former Fort Ord, California, Volume I, Groundwater, Appendix A, Final Revision 1</i>	December 21, 2012
<i>Draft Final Quality Assurance Project Plan, Former Fort Ord, California, Volume I, Groundwater, Appendix A, Groundwater Extraction and Treatment Systems at Operable Unit 2 and Sites 2 and 12; Groundwater Monitoring Program at Sites 2 and 12, Operable Unit 1, Operable Unit 2, and Operable Unit Carbon Tetrachloride Plume</i>	May 31, 2011
<i>Draft Final, QAPP/CDQMP Groundwater Monitoring Program, Sites 2 and 12, OU2 and OUCTP</i>	January 20, 2010
<i>Final Sampling and Analysis Plan, Operable Unit 2 and Sites 2 and 12 Groundwater Treatment Systems, Former Fort Ord</i>	August 20, 2009

2.2 Worksheets #3 and #5: Project Organization and QAPP Distribution

Reporting relationships between organizations involved in the project, including the lead organization, contractors, and subcontractor organizations are identified below.

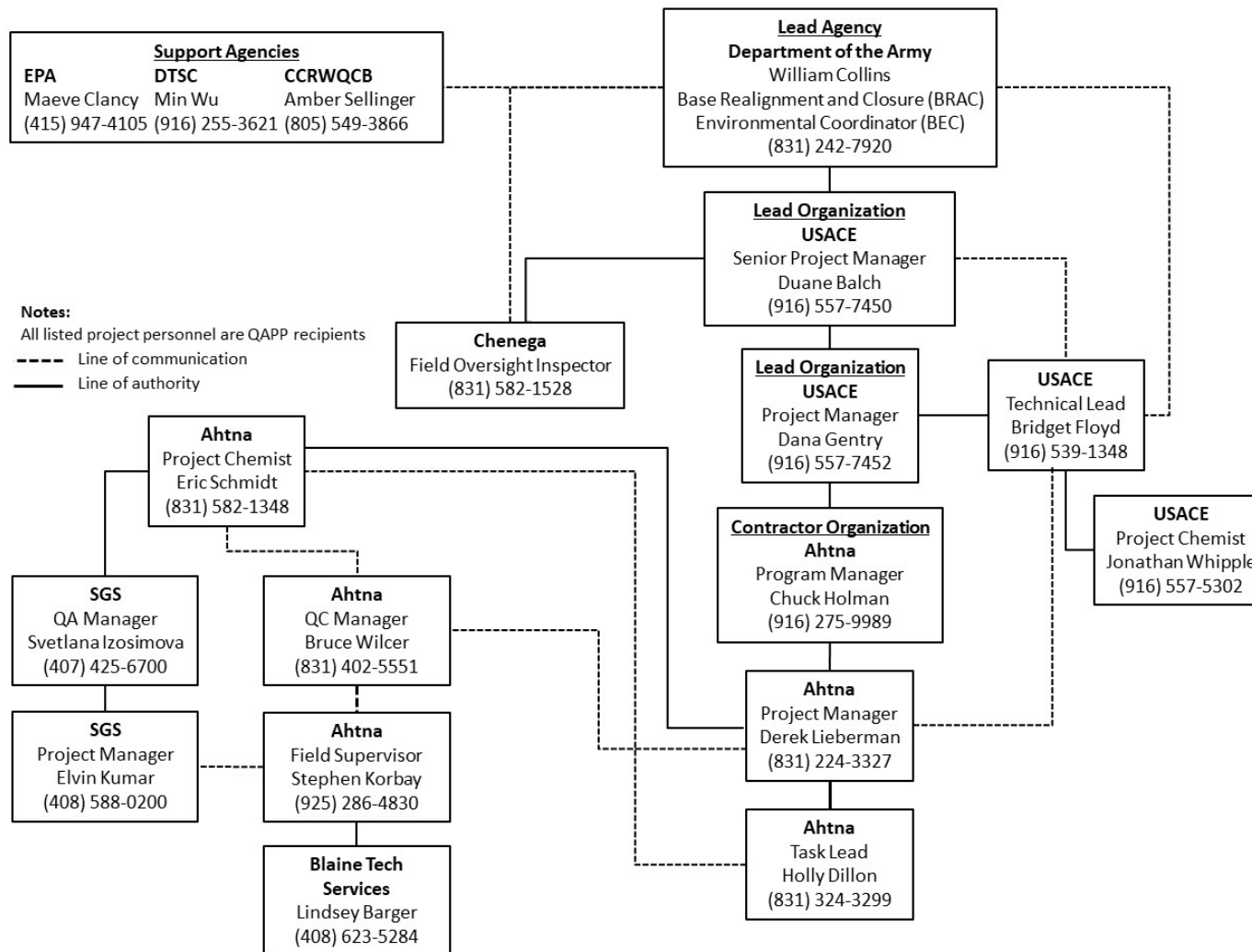

2.3 Worksheets #4, #7, and #8: Personnel Qualifications and Sign-Off Sheet

Organization: Ahtna

Name	Project Title/Role	Education/ Experience	Specialized Training/ Certifications ¹	Signature ²	Date
Chuck Holman	Program Manager	Resume on file	HAZWOPER		
Derek Lieberman	Project Manager	Resume on file	First aid, CPR, MEC, PE, H&S, HAZWOPER, CQM		
Eric Schmidt	Project Chemist	Resume on file	HAZWOPER, CQM		
Holly Dillon	Task Lead	Resume on file	First aid, CPR, MEC, H&S, HAZWOPER, CQM		
Stephen Korbay	Field Supervisor	Resume on file	First aid, CPR, MEC, HAZWOPER, CQM		
Bruce Wilcer	QC Manager	Resume on file	HAZWOPER, CQM		

Notes:

¹ Specialized Training/Certifications Key:

CPR: cardiopulmonary resuscitation

CQM: Construction Quality Management

H&S: health and safety training including, but not limited to: hazard communication, fire extinguisher use, defensive driving, behavior-based safety, confined spaces

HAZWOPER: 40-hour and current 8-hour annual refresher Hazardous Waste Operations and Emergency Response

MEC: munitions and explosives of concern recognition and safety training

PE: registered Professional Engineer

² Signatures indicate personnel have read and agree to implement this QAPP as written.

Worksheets #4, #7, and #8: Personnel Qualifications and Sign-Off Sheet (Continued)

Organization: Blaine Tech Services, Inc.

Name	Project Title/Role	Education/ Experience	Specialized Training/ Certifications ¹	Signature ²	Date
Bart Gebbie	Project Manager	Resume on file	HAZWOPER		
Lindsey Barger	Field Coordinator	Resume on file	HAZWOPER, first aid, CPR		

Notes:

¹ Specialized Training/Certifications Key:

CPR: cardiopulmonary resuscitation

HAZWOPER: 40-hour and current 8-hour annual refresher Hazardous Waste Operations and Emergency Response

MEC: munitions and explosives of concern recognition and safety training

² Signatures indicate personnel have read and agree to implement this QAPP as written.

Worksheets #4, #7, and #8: Personnel Qualifications and Sign-Off Sheet (Continued)

Organization: SGS North America, Inc. (SGS)

Name	Project Title/Role, Location	Education/Experience	Specialized Training/Certifications	Signature ¹	Date
Elvin Kumar	Project Manager, Florida	Resume on file	Not applicable		
Svetlana Izosimova	QA Officer, Florida	Resume on file	Not applicable		
Caitlin Brice	General Manager, Florida	Resume on file	Not applicable		
Norman Farmer	Corporate Technical Director, Florida	Resume on file	Not applicable		

Notes:

¹Signatures indicate personnel have read and agree to implement this QAPP as written.

2.4 Worksheet #6: Communication Pathways

Communication Driver	Responsible Entity	Name	Telephone Number	Procedure (timing, pathways, documentation, etc.)
Point of contact with Army Base Realignment and Closure (BRAC) Office	USACE Technical Lead	Bridget Floyd	(916) 539-1348	Materials and information regarding the project will be forwarded to Army BRAC Office through USACE Technical Lead.
Point of contact for the Lead Organization Project Manager	Ahtna Project Manager	Derek Lieberman	(831) 287-5258	Materials and information regarding the project will be forwarded to USACE by the Ahtna Project Manager.
QAPP changes in the field	Ahtna Project Manager	Derek Lieberman	(831) 287-5258	Ahtna Project Manager will be notified of proposed field changes to the QAPP and shall notify the USACE Technical Lead and USACE Project Chemist prior to implementation.
Daily progress reports/Field QC issues	Ahtna Field Supervisor	Stephen Korbay	(925) 286-4830	Ahtna Field Supervisor will report field/sampling progress and field QC issues to Ahtna Project Manager and Task Leads daily. Ahtna Project Manager or Task Leads will notify the Ahtna QC Manager of issues within one business day.
Field and laboratory data quality issues	Ahtna Project Chemist	Eric Schmidt	(831) 582-1348	Ahtna Project Chemist will report lab QC issues to USACE Technical Lead/USACE Project Manager within two business days.
Data Usability issues	USACE Technical Lead/USACE Project Manager	Bridget Floyd / Dana Gentry	(916) 539-1348 / (916) 557-7452	USACE Technical Lead/USACE Project Manager to inform USACE Project Chemist of any field/laboratory data quality issues that could impact data quality.
Field and analytical corrective actions ¹	Ahtna Field Supervisor	Stephen Korbay	(925) 286-4830	Within two business days of the occurrence, nonconformance and QC issues will be communicated to the Ahtna Project Manager and Project Chemist, who will determine the need for corrective action.

Communication Driver	Responsible Entity	Name	Telephone Number	Procedure (timing, pathways, documentation, etc.)
Release of analytical data	Ahtna Project Chemist	Eric Schmidt	(831) 582-1348	Analytical data will not be released until review or validation is completed, as appropriate. The Ahtna Project Chemist will approve the release of data to the Ahtna Project Manager.
Changes to the QAPP	Ahtna Project Manager	Derek Lieberman	(831) 287-5258	Significant changes to the QAPP must be documented in a Field Change Request and approved by the Ahtna Project Manager, USACE Technical Lead, and USACE Project Chemist prior to implementation. The Lead Organization (USACE) will approve significant corrective actions or procedural changes prior to implementation.
Data import and export	Ahtna Data Manager	Teri Farrell-Bage	(925) 915-6255	The Ahtna Data Manager will upload field data and lab results into the database tracking system.

Notes:

¹ In the event significant corrective action is required for field or laboratory activities, information concerning the corrective action will be provided to the EPA, DTSC, and CCRWQCB by the Army within 30 days of the event or the next scheduled meeting of the BRAC Cleanup Team (BCT), whichever is sooner.

2.5 Worksheet #9: Project Planning Session Summary

Project Name: Former Fort Ord Basewide Groundwater and Soil Vapor Treatment and Monitoring Projected Start Date: Ongoing Project Manager: Derek Lieberman, Ahtna		Site Name: Former Fort Ord Site Location: Former Fort Ord, CA		
Date of Session: April 2, 2021 Scoping Session Purpose: Define scope of work to be included in the QAPP				
Name	Title	Affiliation	Telephone #	E-mail Address
Derek Lieberman	Project Manager	Ahtna	(831) 287-5258	dlieberman@ahtna.net
Eric Schmidt	Project Chemist	Ahtna	(831) 287-5254	eschmidt@ahtna.net
Holly Dillon	Task Lead	Ahtna	(831) 287-5240	hdillon@ahtna.net

Planning Session Summary:

Reviewed contract to determine QAPP requirements and reviewed QAPP Revision 8 for potential updates needed.

Action Items:

Based on this review, Ahtna will:

- Initiate QAPP Revision 9 update.
- After review of the previous four quarters of data (Fourth Quarter 2019 through Third Quarter 2020) and comparison to decision rules in the QAPP, update the list of monitoring and extraction wells to be sampled quarterly and annually. Remove wells from sampling program as allowed by decision rules.
- Review changes to QAPP proposed by SGS, including QSM Version 5.3 changes.

3.0 Project Quality Objectives

3.1 Worksheet #10: Conceptual Site Model

3.1.1 Background and History

The former Fort Ord is located along the Pacific Ocean in northwest Monterey County, approximately 80 miles south of San Francisco, California (Figure 1). The former military installation covers about 28,000 acres, is bounded by Monterey Bay to the west and the Santa Lucia Range to the south, and is surrounded by the cities of Del Rey Oaks, Marina, Sand City, and Seaside. State Highway 1 and the Union Pacific Railroad right-of-way traverse through the western portion of the former Fort Ord, separating the Monterey Bay beachfront from the rest of the installation. The former Fort Ord served as a training and staging facility for infantry troops from 1917 until its closure in 1994. In 1990, the former Fort Ord was placed on the EPA's National Priorities List (NPL),³ primarily due to volatile organic compounds (VOCs) found in groundwater beneath the Fort Ord Landfills. The former Fort Ord was closed in 1994 under the BRAC Act.⁴ Environmental remediation at the former Fort Ord is being completed pursuant to the CERCLA §121 and the National Oil and Hazardous Substances Contingency Plan.

3.1.2 Sources of Known or Suspected Hazardous Waste

Sites 2/12

When the former Fort Ord was an active military facility, Site 2 consisted of the primary sewage treatment facility for Fort Ord and Site 12 included numerous industrial activities, including vehicle maintenance and repair, furniture repair, storage of motor oils, hazardous material storage, vehicle cleaning and degreasing, and disposal of waste and oil.

OU2

The source of the OU2 groundwater contamination was from the Fort Ord Landfills. No detailed records were kept on the amount or types of wastes disposed of at the Fort Ord Landfills; however, household and commercial refuse, ash from incinerated infectious wastes, dried sewage sludge, demolition material, and small amounts of chemical waste (such as paint, waste oil, pesticides, electrical equipment, ink and epoxy adhesives) are believed to have been disposed of in the Fort Ord Landfills (Dames & Moore, 1993).

OUCTP

The apparent source of the OUCTP groundwater plume is located on what is now Lexington Court, a residential area in the northern portion of the former Fort Ord. Historical practices at this site included cleaning electronic equipment and radios.

³ The NPL is the list of national priorities among the known releases or threatened releases of hazardous substances, pollutants, or contaminants throughout the United States and its territories. The NPL is intended primarily to guide the EPA in determining which sites warrant further investigation.

⁴ BRAC is the process the Department of Defense (DoD) has used to reorganize its installation infrastructure to more efficiently and effectively support its forces and increase operational readiness.

3.1.3 Known Contaminants

Known contaminants, or COCs, were identified during Remedial Investigations (RI) at the sites and documented in the decision documents for each site. The COCs are listed in Worksheet #15a and are summarized below.

Sites 2/12

There are eight COCs for groundwater at Sites 2/12, with the primary COCs (those detected at the highest concentrations over the greatest area) identified as tetrachloroethene (PCE) and trichloroethene (TCE). Additionally, PCE and TCE are the two COCs for soil gas at Sites 2/12, which is described in the QAPP Volume I Appendix C for Soil Gas Monitoring (Ahtna, 2020a).

OU2

There are eleven COCs for groundwater at OU2, with the primary COC identified as TCE. Operations and maintenance (O&M) of the Fort Ord Landfills and the landfill gas extraction and treatment system is described separately in the QAPP Volume I, Appendix D, OU2 Landfills (Ahtna, 2020b).

OUCTP

The primary COC in groundwater at OUCTP is carbon tetrachloride (CT); however, there are eight COCs for the A-Aquifer, one COC for the Upper 180-Foot Aquifer, and two COCs in the Lower 180-Foot Aquifer.

3.1.4 Fate and Transport Considerations

Sites 2/12

There are or have been four potential migration pathways specific to Sites 2/12:

- Leaching of chemicals into underlying unsaturated zone soil
- Diffusion of vapor-phase chemicals in soil gas
- Partitioning of chemicals between soil gas and groundwater
- Migration of dissolved phase chemicals in groundwater

Based on environmental conditions, historical data at Sites 2/12, and chemical-specific properties, PCE and TCE are considered to have medium to high persistence and moderate mobility. Soil types present at the site have a low retardation factor and there is insignificant adsorption of these chemicals. Additionally, PCE and TCE water solubilities and partition coefficients indicate moderate mobility. Persistence of PCE and TCE over time and the relative absence of breakdown products indicate little or no reductive dechlorination of these compounds, particularly in soil gas. Concentration-driven diffusion is likely a continuing process at Site 12 given the variation of concentration gradients in the unsaturated zone over time. Additionally, groundwater and soil gas analytical data and modeling during the Remedial Investigation/Feasibility Study Addendum at Sites 2/12 indicated the areas of highest concentrations of PCE and TCE in soil gas were associated with concentrations of PCE and TCE in groundwater that exceed Aquifer Cleanup Levels (ACLs; AES, 2015). Groundwater contamination at Sites 2/12 affected the unconfined Upper 180-Foot Aquifer.

OU2

VOCs remaining in waste disposed of at the Fort Ord Landfills and VOCs detected in landfill gas have the potential to travel through soil pore space to exposure points via a number of mechanisms:

- Advection: mass transport due to bulk flow of water in which contaminants are dissolved
- Dispersion: transport due to the groundwater flow whether or not a compound is dissolved
- Diffusion: spreading of contaminants due to molecular diffusion in response to concentration gradients
- Volatilization: loss of chemical vapor to the atmosphere

VOCs naturally undergo biochemical degradation processes in soil, soil gas, and groundwater; however, the rate of such degradation is limited by oxygen and nutrient sources depending upon the type of degradation that is occurring (aerobic vs. anaerobic). Additionally, degradation of compounds is dependent on the biochemical pathway available.

Groundwater contamination at OU2 affected the A-Aquifer and the Upper 180-Foot Aquifer (Army, 1994). In the vicinity of OU2, the tops of these aquifers typically are first encountered at depths of about 60 feet below ground surface (bgs) and 150 feet bgs, respectively. In monitoring well MW-OU2-73-A, located at the Fort Ord Landfills Area F source area, PCE and TCE are below their ACLs or not detected, but vinyl chloride is detected at the highest concentrations for the OU2 A-Aquifer. Vinyl chloride is a breakdown product in the natural reductive dechlorination process and may indicate this process is occurring locally at Fort Ord Landfills Area F.

Impacts to the underlying groundwater from the Fort Ord Landfills have been greatly mitigated with the implementation of the remedy as prescribed in the OU2 Fort Ord Landfills Record of Decision (OU2 ROD; Army, 1994), which includes an engineered landfill cover system and the GWTS, in addition to operation of the landfill gas extraction and treatment system.

OUCTP

There are or have been four potential migration pathways specific to OUCTP:

- Leaching of chemicals into underlying unsaturated zone soil.
- Diffusion of vapor-phase chemicals in soil gas
- Partitioning of chemicals between soil gas and groundwater
- Migration of dissolved phase chemicals in groundwater

The CT plume appears to have originated from a training facility referred to in 1958 as "ST-11" near what is now Lexington Court. The plume migrated through the vadose zone beneath the vicinity of this facility and into the groundwater of the A-Aquifer, the Upper 180-Foot Aquifer, and the Lower 180-Foot Aquifer; CT has not been detected in the 400-Foot Aquifer.

Hydraulic communication between the A-Aquifer and the underlying aquifers is limited to those areas west of OUCTP where the Fort Ord-Salinas Valley Aquitard (FO-SVA) clay unit pinches out, or where it was penetrated by wells without adequate sanitary seals. Two such vertical conduits were identified that resulted in the migration of CT from the A-Aquifer to the underlying Upper and Lower 180-Foot

Aquifers. All identified vertical conduits have been destroyed (grouted and sealed), eliminating hydraulic communication through the FO-SVA between the A-Aquifer and the underlying aquifers. Groundwater in the Upper 180-Foot Aquifer flows to the southeast toward the apparent discontinuity in the underlying Intermediate 180-Foot Aquitard where it then recharges the Lower 180-Foot Aquifer. Groundwater in the Lower 180-Foot Aquifer primarily migrates to the east (Army, 2008).

In addition to CT, chloroform, TCE, and PCE were also present both within the vadose zone (vapor-phase) and in the A-Aquifer near the source (dissolved phase).⁵ Chloroform is a biodegradation product of CT and its presence in OUCTP suggests there are native microbial bacteria acting within the subsurface to biodegrade CT. The presence of PCE and TCE in soil gas near the source area suggests these compounds were also disposed of in this area, presumably during the use of the same training facility.

In addition to CT, TCE is also present in the Lower 180-Foot Aquifer, which suggests groundwater originating from OU2 in the Upper 180-Foot Aquifer may be flowing from the southwest toward the apparent discontinuity in the Intermediate 180-Foot Aquitard (Ahtna, 2021c).

3.1.5 Potential Receptors and Exposure Pathways

Groundwater at Sites 2/12, OU2, and OUCTP is not currently used for domestic household purposes by residents within the Fort Ord area. Drinking water in the Fort Ord area is provided by the Marina Coast Water District (MCWD) and is pumped from wells that are located east of the Sites 2/12, OU2, and OUCTP areas. These supply wells are screened in the Lower 180-Foot Aquifer or deeper aquifers. Groundwater within the Sites 2/12, OU2, and OUCTP areas is located in the Prohibition Zone of the Special Groundwater Protection Zone at the former Fort Ord, and Monterey County restricts installation of new supply wells in this zone. According to Monterey County Code Title 15 Section 15.08.140, a prohibition zone is an area overlying or adjacent to a contaminant plume where water well construction is prohibited and applications for water wells will not be accepted; therefore, direct contact groundwater exposure pathways for residents potentially exposed to groundwater from the Sites 2/12, OU2 and OUCTP areas are currently incomplete and are expected to remain so in the future. Volumes III and IV of the Basewide Remedial Investigation/Feasibility Study (HLA, 1995) provide details on the potential receptors and exposure pathways.

3.1.6 Land Use Considerations

Sites 2/12

The Site 12 area was redeveloped into a commercial retail area identified as The Dunes on Monterey Bay, which included construction of several big-box stores, a movie theater complex, food services, and a large parking area.

The Site 2 area remains undeveloped and open to the general public as part of Fort Ord Dunes State Park. The Site 2 area was proposed for reuse as an aquaculture and oceanographic research facility, and

⁵ There have been no detectable concentrations of PCE and TCE breakdown products (i.e., cis-1,2-DCE and vinyl chloride) to indicate biodegradation of PCE and TCE in the source area.

later as a desalination plant (FORA, 1997); however, the site remains unused with the derelict sewage treatment plant facilities still onsite.

OU2

The OU2 area consists of the Fort Ord Landfills, which encompass approximately 120 acres of land that is undeveloped other than use as a landfill, as well as mixed-use residential, commercial, and undeveloped areas. The Army currently uses Fort Ord Landfills Area E for disposal of contaminated soil from the Site 39 Inland Ranges. The Fort Ord Landfills are the apparent historical source of the OU2 groundwater COC plume, which extends across an area bounded by 3rd Avenue, Abrams Drive, Bunker Hill Drive, and Inter-Garrison Road.

OUCTP

The apparent source of the OUCTP is located on what is now Lexington Court, part of the Abrams Housing Development, in the northern portion of the former Fort Ord. The groundwater COC plume emanating from this area ultimately extends across an area bounded by Del Monte Boulevard, Abrams Drive, Neeson Road, and Blanco Road. The OUCTP area consists of mixed-use residential, commercial, light industrial, and undeveloped areas, including habitat reserve areas.

3.1.7 Physiography and Topography

The predominant topography of the area reflects a morphology typical of the dune sand deposits that underlie the western and northern portions of the former Fort Ord. In these areas, the ground surface slopes gently to the west and northwest, draining toward Monterey Bay. Runoff is minimal because of the high rate of surface-water infiltration into the permeable dune sand. Consequently, well-developed natural drainages are absent throughout much of this area. Closed drainage depressions typical of dune topography are common. Elevations at the former Fort Ord range from approximately 50 feet above mean sea level (MSL) at Site 2 to 250 feet above MSL at the Fort Ord Landfills.

3.1.8 Geology and Hydrology

The predominant lithology is a loose, well-sorted (poorly graded) fine to medium sand. The sands represent active and recently active dunes and older Pleistocene-age dune sands. The active dune sands parallel the beach and extend several hundred feet inland. The older dune sands cover most of the northern and western portions of the former Fort Ord. Paleosols, representing former ground surfaces (silty sands), exist within these sands. These paleosols indicate that one or more cycles of dune deposition have occurred with intervening periods of soil development. The paleosols in the dunes bordering the beach indicate that older dune sand is locally present beneath the recent dune sand.

Three groundwater aquifers are in the remediation phase of cleanup activities at the former Fort Ord: the unconfined A-Aquifer, the unconfined and confined Upper 180-Foot Aquifer, and the confined Lower 180-Foot Aquifer. The aquifers consist predominantly of fine to coarse-grained sands which are separated by silty clay or clayey fine-grained sand aquitards. The A-Aquifer is located within the recent dune sands and is perched above the regional FO-SVA. To the west where the FO-SVA pinches out, the unconfined A-Aquifer and confined Upper 180-Foot Aquifer combine to form a continuous, unconfined

hydrostratigraphic unit (identified as the unconfined Upper 180-Foot Aquifer). A north-trending groundwater divide in the unconfined Upper 180-Foot Aquifer exists midway between the FO-SVA and Monterey Bay. Groundwater in the unconfined Upper 180-Foot Aquifer west of the divide flows west and discharges to the Monterey Bay. Groundwater in the unconfined Upper 180-Foot Aquifer east of the divide flows under the FO-SVA (becoming confined) toward the Salinas Valley due predominantly to agricultural pumping. The Upper and Lower 180-Foot Aquifers, and portions of the 400-Foot Aquifer (locally) are contained within valley fill deposits. The Upper 180-Foot Aquifer is separated from the Lower 180-Foot Aquifer by the Intermediate 180-Foot Aquitard, which appears to be laterally discontinuous in the eastern portion of the former Fort Ord near the OU2 and OUCTP areas creating a natural conduit between the aquifers (Army, 2008).

3.2 Worksheet #11: Project/Data Quality Objectives

Data quality objectives (DQOs) are qualitative and quantitative statements that outline the decision-making process and specify the data required to support corrective actions. DQOs specify the level of uncertainty that will be accepted in results derived from data. The DQO process used for developing data quality criteria and performance specifications for decision-making is consistent with the *Guidance on Systematic Planning Using the Data Quality Objectives Process*, EPA QA/G-4 (EPA, 2006). The DQO process consists of the following seven steps:

- Step 1: State the problem
- Step 2: Identify the goals of the study
- Step 3: Identify information inputs
- Step 4: Define the boundaries of the study
- Step 5: Develop the analytical approach
- Step 6: Specify performance or acceptance criteria
- Step 7: Develop the plan for obtaining data

The DQOs steps are presented below for the five operable units (OUs):

- Sites 2/12 Upper 180-Foot Aquifer
- OU2 A-Aquifer and Upper 180-Foot Aquifer
- OUCTP A-Aquifer
- OUCTP Upper 180-Foot Aquifer
- OUCTP Lower 180-Foot Aquifer

During cleanup, a site can be divided into a number of distinct areas depending on the complexity of the problems associated with the site. These areas, or OUs, may address geographic areas of a site, specific site problems, or areas where a specific action is required. For Sites 2/12 and OU2, the same remedy is applied to all affected aquifers; however, for OUCTP, each affected aquifer has a distinct remedy.

3.2.1 Step 1: State the Problem

Concentrations of VOCs (primarily PCE, TCE, CT, and related breakdown products) are present in groundwater at the former Fort Ord at concentrations above the ACLs prescribed in the relevant RODs or Explanations of Significant Differences (ESDs), thereby requiring periodic monitoring and reporting of groundwater conditions and VOC concentrations to the CCRWQCB, DTSC, EPA, and USACE. Groundwater contamination is present in three aquifers within and adjacent to the former Fort Ord footprint: A-Aquifer, Upper 180-Foot Aquifer, and the Lower 180-Foot. Three main study areas have been identified, and comprise the majority of the GWMP: Sites 2/12 (one aquifer: Upper 180-Foot Aquifer), OU2 (two aquifers: A-Aquifer and Upper 180-Foot Aquifer), and OUCTP (three aquifers: A-Aquifer, Upper 180-Foot Aquifer, and Lower 180-Foot).

Sites 2/12

Groundwater in the Upper 180-Foot Aquifer beneath Sites 2/12 has been adversely impacted by eight VOCs (Worksheet #15a) that are identified in the Basewide Remedial Investigation Sites Record of Decision (RI Sites ROD; Army, 1997). These compounds are identified as COCs because they are present in groundwater at levels that pose an unacceptable risk to human health or the environment. As a result, the RI Sites ROD and the RI Sites ESD (Army, 2016) require remediation of the Upper 180-Foot Aquifer beneath and downgradient of Sites 2/12 using groundwater extraction with liquid-phase granular activated carbon (GAC) treatment and soil gas extraction with vapor-phase GAC treatment (Ahtna, 2019). Figure 2 shows the Sites 2/12 monitoring and extraction well locations by sampling schedule, Figure 3 shows the Sites 2/12 GWTS configuration with current extraction well status, and Figure 4 shows the Sites 2/12 groundwater treatment plant (GWTP) schematic and sampling locations. A detailed discussion of the soil vapor extraction and treatment system can be found in the Soil Gas QAPP (Ahtna, 2020a).

Improper disposal of solvents from former activities in this area led to contamination of the groundwater by COCs at concentrations above ACLs. The extent of the plume is defined by the detectable presence of PCE in groundwater, as it is the most common and widespread chemical constituent in this area. Active remedial action at Sites 2/12 consists of groundwater extraction and treatment by liquid-phase GAC since 1999, and soil gas extraction and treatment by vapor-phase GAC since 2015. Additionally, monitoring wells at Sites 2/12 are subject to seawater intrusion due to their proximity to Monterey Bay; as a result, chloride concentrations are monitored annually at select wells.

OU2

Groundwater in the A-Aquifer and Upper 180-Foot Aquifer beneath and downgradient from the Fort Ord Landfills has been adversely impacted by 11 VOCs. These compounds were identified as COCs (Worksheet #15a) in the OU2 ROD (Army, 1994) because they are present in groundwater at levels that pose an unacceptable risk to human health or the environment. As a result, the OU2 ROD and the OU2 ESD (Army, 1995) require remediation of the A-Aquifer and Upper 180-Foot Aquifer beneath and downgradient of OU2 using groundwater extraction with GAC treatment and treated water recharged to the aquifer or reused at the surface. Figures 5 and 6 show the OU2 monitoring and extraction well locations by sampling schedule, Figure 7 shows the OU2 GWTS configuration with current extraction well status, and Figure 8 shows the OU2 GWTP schematic and sampling locations.

COC migration from landfills covering 150 acres in the area has led to contamination of the groundwater by COCs at concentrations above ACLs. The extent of the plume is defined by the detectable presence of TCE in groundwater, as it is the most common and widespread chemical constituent in this area. Active and ongoing (since 1995) remediation at OU2 consists of extraction and GAC treatment of groundwater.

Disposal of spent small arms ammunition in the Fort Ord Landfills was also identified as a possible source for metals (antimony, copper, and lead) contamination of the groundwater. Metals are not identified as COCs for groundwater in the OU2 ROD and therefore do not have ACLs. However, metals (antimony, copper, and lead) concentrations are monitored at select wells around the Fort Ord Landfills

annually to validate that groundwater is not impacted by soil and spent small arms ammunition disposed of in the Fort Ord Landfills during remediation of small arms firing ranges at Fort Ord.

OUCTP A-Aquifer

Improper disposal of CT (used as a cleaning solvent for activities conducted in this area) led to contamination of the groundwater (Army, 2008). The extent of the OUCTP in the A-Aquifer is defined by the detectable presence of CT in groundwater, as it is the most common and widespread chemical constituent in this area. Remedial action at OUCTP includes a combination of enhanced *in situ* bioremediation (EISB) and monitored natural attenuation (MNA). EISB treatment began with the pilot study starting in 2008 and was completed in 2012 at Deployment Areas 1 and 2. Post-treatment and long-term groundwater monitoring have been conducted since 2012 (AES, 2014). Figure 9 shows the OUCTP A-Aquifer monitoring well locations by sampling schedule.

Additional monitoring wells were installed in 2011 and 2015 to close data gaps for the MNA remedy. The wells installed in 2015 indicated the CT groundwater plume was migrating northeast of the A-Aquifer groundwater divide (Figure 9) and construction of EISB Deployment Area 3 was recommended, as shown in Figure 10. EISB Deployment Area 3A construction was completed and remedial operations began on December 1, 2016. Operations were completed on August 4, 2017 and post-treatment long-term performance monitoring is continuing according to the *Final Operable Unit Carbon Tetrachloride Plume Remedial Action Work Plan Addendum, Former Fort Ord, California* (AES, 2014).

The effectiveness of EISB treatment is determined through periodic monitoring and reporting of groundwater quality parameters in specific wells (Worksheet #17c3) and VOC concentrations (Worksheet #15a) to the CCRWQCB, DTSC, EPA, and USACE. Groundwater quality parameters include dissolved oxygen (DO) and oxidation-reduction potential (ORP).

OUCTP Upper 180-Foot Aquifer

Groundwater in the Upper 180-Foot Aquifer at OUCTP has been adversely impacted by CT (Worksheet #15a), as identified in the OUCTP ROD (Army, 2008). This compound is identified as a COC because it is present in groundwater at levels that pose an unacceptable risk to human health or the environment. As a result, the OUCTP ROD requires remediation of OUCTP in the Upper 180-Foot Aquifer using groundwater extraction and treatment via the existing OU2 GWTS. Figure 11 shows the OUCTP Upper 180-Foot Aquifer monitoring well locations by sampling schedule. Figure 7 shows the location of the OUCTP Upper 180-Foot Aquifer extraction well, EW-OU2-09-180.

OUCTP Lower 180-Foot Aquifer

Groundwater in the Lower 180-Foot Aquifer at OUCTP has been adversely impacted by CT (Worksheet #15a) as identified in the OUCTP ROD (Army, 2008). The remediation of the Lower 180-Foot Aquifer includes MNA and contingency wellhead treatment of the nearby MCWD supply wells. Figure 12 shows the OUCTP Lower 180-Foot Aquifer monitoring well locations by sampling schedule. Groundwater in the Lower 180-Foot Aquifer has been adversely impacted by TCE at concentrations exceeding the maximum contaminant level (MCL) for drinking water, which suggests groundwater originating from OU2 in the

Upper 180-Foot Aquifer may be flowing from the southwest toward the apparent discontinuity in the Intermediate 180-Foot Aquitard (Army, 2008 and Ahtna, 2021c).⁶

3.2.2 Step 2: Identify the Goals of the Study

The primary goals associated with the Sites 2/12, OU2, and OUCTP remediation projects are to monitor the programs and verify they reflect current site conditions and whether the sites are in continued compliance with the RI Sites ROD (Army, 1997) and ESD (Army, 2016), OU2 ROD (Army, 1994) and ESD (Army, 1995), and the OUCTP ROD (Army, 2008), respectively.

Sites 2/12 and OU2 GWTSs

Data collected from the Sites 2/12 and OU2 GWTS will be used to perform the following assessments:

- Evaluate whether the GWTSs are effectively and efficiently reducing concentrations of COCs in the aquifers of concern.
- Assess whether GWTS effluent meets discharge requirements before it is used for groundwater recharge or onsite for non-potable construction purposes (dust control, soil compaction, etc.).
- Evaluate when the GWTS GAC requires change-out.
- Evaluate whether the GWTS provides adequate hydraulic containment of the COC plume and prevents its migration.
- Assess whether ACLs have been achieved for COCs within project boundaries and whether closure of the site or OU is warranted.
- Assess whether the current extraction well sampling frequency is adequate to meet project objectives.

Sites 2/12, OU2, and OUCTP GWMP

The data collected from the Fort Ord GWMP are used to evaluate the following decisions:

- Are concentrations of COCs in groundwater above the relevant ROD- or ESD-prescribed ACLs?
- What is the vertical and lateral extent of relevant ROD-specified COCs in groundwater?
- Are concentrations of TCE in the Lower 180-Foot Aquifer above the MCL?
- What is the vertical and lateral extent of TCE in the Lower 180-Foot Aquifer?
- What is the source of TCE in the Lower 180-Foot Aquifer?
- What are the groundwater and aquifer conditions relative to the stability of the contaminant plumes, and what trends and temporal changes in groundwater levels and COC concentrations are taking place?
- Does the conceptual site model need to be updated or verified?

⁶ TCE is not a COC for OUCTP in the Lower 180-Foot Aquifer; however, TCE concentrations are monitored to evaluate potential impacts to downgradient Fort Ord supply wells FO-29, FO-30, and FO-31 (Figure 10C), and the applicability of OU2 and OUCTP decision documents with respect to TCE in the Lower 180-Foot Aquifer will be addressed in the next Five Year Review.

- Is closure of the site or OU, or a hydraulic zone within the site or OU, warranted if concentrations of COCs in groundwater are less than or equal to the relevant ROD- or ESD-prescribed ACLs?
- Are concentrations of chloride in monitoring wells at Sites 2/12 above the Monterey County Water Resources Agency threshold of 500 mg/L for classification as “seawater intruded”?
- Are concentrations of dissolved antimony, copper, and lead above MCLs for drinking water in wells associated with the Fort Ord Landfills?⁷
- Do post-treatment DO and ORP measurements in the OUCTP A-Aquifer monitoring wells indicate biodegradation is still occurring in the EISB Deployment Areas?

3.2.3 Step 3: Identify Information Inputs

Sites 2/12 and OU2 GWTSs

Inputs to decisions for the Sites 2/12 and OU2 GWTS are as follows:

- COC concentration data from extraction well samples collected to assess relative concentrations in the aquifer and whether ACLs have been met for COCs.
- COC concentration data from locations within the GWTS collected to assess whether the GWTS is operating effectively and efficiently.
- COC concentration data from TS-212-INJ and TS-OU2-INJ to confirm whether site-specific discharge requirements (Worksheet #15a) are met.
- COC concentration data from GAC treatment effluent collected to determine whether a GAC change-out is required.
- GWTS flow rate data collected to evaluate and document system operation.
- Groundwater monitoring data and/or groundwater flow modeling results to determine whether the plume is hydraulically contained.

Sites 2/12, OU2, and OUCTP GWMP

Decision inputs for the Fort Ord GWMP are as follows:

- Historical groundwater monitoring results and archived information
- Historical knowledge of geologic and hydrologic conditions at Fort Ord
- Groundwater modeling data from recent trend analysis
- Statistical analysis of COC concentration trends on a well-by-well basis
- ROD- or ESD-prescribed ACLs

⁷ Antimony, copper, and lead are the primary metals found in spent ammunition deposited in the Fort Ord Landfills, but are not identified as COCs for groundwater in the OU2 ROD and do not have ACLs; therefore, detected concentrations are compared to MCLs for drinking water. The Federal and California MCLs for antimony, copper and lead are the same numerical value (see Worksheet #15c). The MCL is the maximum concentration of a chemical that is allowed in public drinking water systems, though the groundwater being monitored is within the Prohibition Zone and is not intended for use as drinking water (see Section 3.1.5).

- State of California MCLs for drinking water
- Fort Ord GWTS operational data and monitoring results
- Drinking water production well data from local districts and municipalities

3.2.4 Step 4: Define the Boundaries of the Study

The physical study boundaries for the Sites 2/12, OU2, and OUCTP groundwater remedies are described below and shown in Figure 1. Study boundaries are further divided into hydraulic zones based on the zone of groundwater with COC concentrations above ACLs and influenced by the groundwater remedy; therefore, hydraulic zones and study boundaries may be revised depending on changes in the extent of groundwater with COC concentrations above ACLs and modifications to the groundwater remedies. The long-term temporal boundaries for the remedies are indefinite; however, groundwater monitoring should continue at the sites in accordance with the decision rules presented in Step 5 of Worksheet #11 until the project objectives are met.

The overall geographic boundary for the site is the Main Garrison at the former Fort Ord including the Fritzsche Army Airfield area,⁸ and the adjacent portion of the City of Marina. The lateral boundary is defined by the zone of groundwater impacted or potentially impacted by VOCs. The vertical boundary is defined by the zone of contaminated groundwater in the following aquifers or hydrogeologic units.

- A-Aquifer
- Upper 180-Foot Aquifer
- Lower 180-Foot Aquifer

The extent of groundwater with COC concentrations above ACLs is represented by the COC concentration contours shown on figures presented in quarterly and annual reports. COC analytical data are grouped by site for COC concentrations above ACLs and ArcGIS Desktop 10.8.1 (ESRI, 2020) is used to generate shapefiles depicting the COC concentration contours. Adjustments are made to the contours based on comparative evaluation of current COC concentrations and contours from previous quarters. If more than one sample is collected from a well in a quarterly monitoring event, the sample with the highest detected COC concentration will be used for generating the contour. The COC concentration contours can be compared to historical contours and used to optimize hydraulic zones and study boundaries, and interpret progress toward achieving remedial action objectives.

Groundwater elevations in each aquifer are represented by groundwater elevation contours shown on figures presented in quarterly and annual reports. Groundwater levels are measured each quarter at the wells listed in Worksheet #17 and compared to the wells' known top of casing elevation to determine the groundwater elevation at each well. For multi-port wells that have multiple ports in one aquifer, the groundwater level data from all the ports are averaged to determine the groundwater elevation at that location. Groundwater elevation data sets are imported into the Surfer® 15 (Golden Software, LLC) software application. Within Surfer® 15, the geostatistical gridding method (i.e., kriging) is used to interpolate a gridded surface from the groundwater elevation data. Point kriging, with a circular search

⁸ Now the Marina Municipal Airport.

ellipse and without a drift type (i.e., ordinary kriging), is used to estimate grid node values based on the known data points near the node with the data points weighted by their distance from the node. The size of the grid cells is set to approximately 30 feet by 30 feet. Once the grid is constructed, Surfer® 15 uses linear interpolation to generate contour lines of equal elevation based on the grid node values. Contour lines for each aquifer are exported from Surfer® 15 as shapefiles and imported into ArcGIS Desktop 10.4 (ESRI, 2017) for final manual adjustments, such as trimming the extents of the contours and smoothing curves. Finally, extraction well operation data are compared to measured groundwater levels at those wells and cones of depression are added manually around operating extraction wells. Groundwater elevation contours can then be used to interpret the flow characteristics of groundwater in each of the aquifers.

The time frame for decision-making relates to the quarterly monitoring and reporting schedule and periodic (e.g., annual) reporting and review cycles. With the exception of certain times of the year when the presence of sensitive biological resources requires modification to the site or well access procedures, practical constraints on data collection are not applicable to this project.

Sites 2/12

Study boundaries at Sites 2/12 are as follows:

- The overall geographic boundary for the site is within the western Main Garrison area at the former Fort Ord.
- The lateral boundary is defined by the zone of groundwater impacted by COCs. The vertical boundary is defined by the zone of contaminated groundwater in the Upper 180-Foot Aquifer.
- Because the zone of contaminated groundwater is relatively small, limited to a single aquifer, and within the capture area of the existing extraction well network, there is currently only one hydraulic zone at Sites 2/12.

OU2

Study boundaries at OU2 are as follows:

- The overall geographic boundary for the site is the Main Garrison area and the Fort Ord Landfills at the former Fort Ord.
- The lateral boundary is defined by the zone of groundwater impacted by COCs. The vertical boundary is defined by the zone of contaminated groundwater in the A-Aquifer and Upper 180-Foot Aquifer.
- The study boundaries for OU2 are further divided into eight hydraulic zones based on the extent of the COC plumes in the A-Aquifer and Upper 180-Foot Aquifer, and groundwater extraction well network capture areas (Figures 13 and 14).

OUCTP

Study boundaries at OUCTP are as follows:

- The overall geographic boundary for the site is the Main Garrison area north of the Fort Ord Landfills at the former Fort Ord.

- The lateral and vertical boundaries are defined by the zone of groundwater impacted by COCs in the A-Aquifer, Upper 180-Foot Aquifer, and Lower 180-Foot Aquifer.
- The study boundaries for OUCTP are further divided into seven hydraulic zones based on the extent of the COC plumes in the A-Aquifer, Upper 180-Foot Aquifer and Lower 180-Foot Aquifer, and the areas of groundwater remedy influence for each aquifer (Figures 15, 16, and 17).

3.2.5 Step 5: Develop the Analytical Approach

The analytical approach has been developed by using decision rules on information inputs to support the goals of the project for the GWTSs and GWMP.

Sites 2/12 and OU2 GWTSs

Decision rules for the Sites 2/12 and OU2 GWTS have been developed to address the five major components of treatment system operation: discharge limit compliance, GAC change-out, hydraulic containment, sampling frequency, and plume remediation. Each of these components is described below.

Discharge Limit Compliance

- If analytical results indicate COC discharge limits (Worksheet #15a) are being met, then the system will continue to operate and GWTS effluent will be recharged to the aquifer.
- If analytical results indicate the discharge limit for any COC other than methylene chloride⁹ is not met, then a confirmation sample will be collected and analyzed with a 24-hour turnaround time (TAT).
- If analytical results indicate the discharge limit for methylene chloride is not met, then the analytical results will be evaluated against QC sample analytical results associated with the same sampling event.
 - If the evaluation indicates the presence of methylene chloride above the discharge limit is not representative of groundwater conditions due to associated QC sample detections, then the OU2 GWTS will continue to operate and effluent will be recharged to the aquifer.
 - If the evaluation indicates the concentration of methylene chloride above the discharge limit is representative of groundwater conditions, then a confirmation sample will be collected from the OU2 GWTS discharge point of compliance and analyzed with a 24-hour TAT.
- If confirmation sample analytical results indicate the discharge limit for any COC is not met, then the affected GWTS will be shut down, operating conditions and GAC loading evaluated, extraction well flow rates adjusted as necessary, and a variance report issued for any out-of-

⁹ Methylene chloride is a COC for OU2 and OUCTP in the A-Aquifer. EPA Method 8260-SIM, Analysis of Volatile Organics by GC/MS, Select Ion Monitoring (SIM) (Attachment A, SGS SOP# MS010) identifies methylene chloride as a common laboratory contaminant detected in the analysis for volatile organics.

limits operation. Following operational changes, which may include GAC change-out, the GWTS will be restarted and re-sampled to verify compliance.

- If verification sample analytical results indicate discharge limits for COCs are being met, then the system will continue to operate and system effluent will be recharged to the aquifer.
- If verification sample analytical results indicate the discharge limit for any COC is not met, then the affected GWTS will be shut down, and operating conditions and GAC loading re-evaluated. Following operational changes, the GWTS will be restarted and re-sampled to verify compliance.

GAC Change-out

The decision rules for determining when a GAC change-out is needed at the Sites 2/12 GWTP are:

- If analytical results for TCE and PCE from a process sample collected immediately downstream of the GAC vessel (upstream of the air stripper) are less than or equal to 90 percent (%) of ACLs, then a GAC change-out is not necessary. The Sites 2/12 system will continue to operate and the final effluent stream will continue to be recharged to the aquifer.
- If the analytical result for TCE or PCE from a process sample collected immediately downstream of the GAC vessel (upstream of the air stripper) is greater than 90% of ACLs, then a GAC change-out will be scheduled.

The *Operations and Maintenance Manual, Operable Unit 2 (OU 2) Groundwater Treatment Plant, Former Fort Ord* (OU2 GWTP O&M Manual; JV, 2019) provides procedures for O&M of the OU2 GWTS. The OU2 GWTP O&M Manual describes the conditions required for GAC change-out, but those instructions are superseded by the following based on Ahtna's experience operating GWTSs using liquid-phase GAC as the primary treatment technology. At the OU2 GWTP, the average concentration of each COC in the lead GAC vessel effluent will be calculated based on analytical results from process samples collected immediately downstream of the lead GAC vessel (upstream of the second GAC vessel) during each process sampling event (where such samples are collected). Decision rules for determining when a GAC change-out at OU2 is necessary are:

- If the average concentration of each COC is less than 90% of its respective ACL (Worksheet #15a), then a GAC change-out is not necessary. The OU2 system will continue to operate and the final effluent stream will continue to be recharged to the aquifer.
- If the average concentration of any COC other than methylene chloride is equal to or greater than 90% of its ACL, a GAC change-out will be scheduled.
- If the average concentration of methylene chloride is equal to or greater than 90% of its ACL, then the analytical results for the lead GAC vessel effluent sample will be evaluated against the analytical results for QC samples associated with the same sampling event.
 - If the evaluation indicates an average concentration of methylene chloride greater than 90% of its ACL is not representative of groundwater conditions due to associated QC sample detections, then a GAC change-out is not necessary. The system will continue to operate and OU2 GWTS effluent will be recharged to the aquifer.

- If the evaluation indicates the concentration of methylene chloride above the discharge limit is representative of groundwater conditions and the average concentration of methylene chloride is equal to or greater than 90% of its ACL, a GAC change-out will be scheduled.

Hydraulic Containment

During remediation system operation, specific decision rules must be followed to demonstrate COC plume capture. The decision rules are:

- If groundwater monitoring and/or groundwater flow modeling demonstrate plume capture is occurring, then system operation will continue as currently configured. During operation, extraction well flow rates may be optimized to reduce O&M costs while maintaining plume capture.
- If the system flow rate data, in conjunction with the groundwater flow model, indicate the plume is being hydraulically contained, then the system will continue to operate.
- If groundwater monitoring and/or groundwater flow modeling indicate plume capture is not occurring, additional groundwater flow modeling will be conducted to determine whether adjustment of either extraction or recharge flow rates will improve capture or whether additional extraction wells or recharge points are required. Based on this evaluation, system reconfiguration may be recommended.

Plume Remediation

Assessment of aquifer cleanup resulting from the Sites 2/12 and OU2 GWTS is conducted through a GWMP that evaluates plume migration and COC concentrations. Extraction well monitoring data will be used for evaluating the operational status of individual extraction wells and for statistical evaluations of remediation progress. The decision rules for determining the operational status of groundwater extraction wells with respect to plume remediation are:

- An extraction well will continue to operate if any COC detected is greater than the corresponding ACL (Worksheet #15a).
- An extraction well will continue to operate if the extraction well flow rate data and analytical data from nearby wells, in conjunction with groundwater flow modeling, indicate operation of the extraction well is necessary for hydraulic containment of the plume.
- An extraction well will be shut off if COCs detected are less than the ACL for two consecutive quarterly monitoring events, and if the extraction well flow rate data and analytical data from nearby wells, in conjunction with groundwater flow modeling, indicate operation of the extraction well is no longer necessary for hydraulic containment of the plume.
- Following termination of pumping at an extraction well, the well will be incorporated into the GWMP.

Sampling Frequency

Extraction wells will be sampled quarterly when operating as part of the GWTS. The decision rules for determining the sampling frequency and monitoring status for groundwater extraction wells following termination of operation are:

- If four consecutive quarters of monitoring data show concentrations of COCs are below their respective limits of quantitation (LOQs) (Worksheet #15a) or below 10% of their respective ACLs (Worksheet #15a), whichever is greater, an annual monitoring schedule may be proposed.
- If two annual monitoring results show concentrations of COCs are below their respective LOQs or below 10% of their respective ACLs, whichever is greater, then the well may be proposed for removal from the sampling program.
- If wells adjacent to a well sampled annually, or no longer sampled, show detections of any COCs equal to or greater than their ACLs, then the well monitoring frequency may be increased to quarterly.
- If an annual well monitoring result shows a detection of any COC equal to or greater than its ACL, then the well monitoring frequency may be increased to quarterly.
- If a well is no longer needed for the program, it will be proposed for decommissioning.

Implementation of agency-approved exit strategies for Sites 2/12, OU2, and OUCTP, or portions thereof, may result in modification of these decision rules.

The statistical parameter of interest is the maximum value detected in the well or monitoring point compared to the ACLs or historical trend for that well or monitoring point. For perimeter control, the minimum value detected in the monitoring point (e.g., non-detect [ND] at the limit of detection [LOD]) is the statistical parameter of interest.

OU2, Sites 2/12, and OUCTP GWMP

The decision rules for groundwater monitoring are:

- If four consecutive quarters of monitoring data show concentrations of COCs below their respective LOQs, or below 10% of their respective ACLs (Worksheet #15a), whichever is greater, then an annual sampling schedule may be proposed.
- If two consecutive annual monitoring results show concentrations of COCs below their respective LOQs or below 10% of their respective ACLs, whichever is greater, then the well may be proposed for removal from the sampling program.¹⁰
- If wells adjacent to a well sampled annually, or no longer sampled, show detections of any COCs equal to or greater than their ACLs, then the well monitoring frequency may be increased to quarterly.
- If an annual well monitoring result shows a detection of any COC equal to or greater than its ACL, then the well monitoring frequency may be increased to quarterly.

¹⁰ The well will continue to be monitored for depth to water until it is decommissioned or determined to be redundant or unnecessary water elevation data.

- If monitoring or modeling input indicates the groundwater monitoring network no longer provides vertical or lateral control of COCs, then additional groundwater wells may be proposed to be added to the program.
- If a groundwater monitoring well is no longer needed for the program, it will be proposed for decommissioning.
- If a monitoring well in Sites 2/12 is determined to be intruded by seawater based on chloride data, the GWTS operator and Project Manager will be notified to implement possible GWTS changes.
- If concentrations of dissolved copper, lead, and antimony in select A-Aquifer wells (Worksheet #17c) exceed MCLs, the BCT will be notified.

Decisions regarding application of passive diffusion bags (PDBs) are described in the *Technical Memorandum Passive Diffusion Bag Pilot Study Results and Recommendations* (Harding ESE, 2001).

OUCTP A-Aquifer EISB Post-Treatment Water Quality Parameter Monitoring

The parameters of interest for the OUCTP A-Aquifer are DO and ORP levels compared to the baseline values or historical trend for that well or monitoring point to evaluate the effectiveness of EISB. The decision rules for determining the monitoring frequency for post-treatment groundwater quality parameters are:

- Continue quarterly monitoring of post-treatment groundwater quality parameters if measurements indicate continued aquifer conditions are affected by the associated EISB treatment at the well; or measurements at one or more adjacent wells indicate aquifer conditions are affected by the associated EISB treatment; or measurements at one or more wells in an immediately upgradient Deployment Area indicates aquifer conditions are affected by the associated EISB treatment;
- If two consecutive quarters of post-treatment water quality parameter monitoring data show both DO and ORP measurements have returned to the approximate levels of recorded baseline conditions,¹¹ then water quality parameter monitoring may be reduced to an annual frequency at the well; or,
- If four consecutive quarters of post-treatment water quality parameter monitoring data show there has been no effect on the well by EISB treatment (i.e., there has been no significant deviation from recorded baseline conditions),¹² then water quality parameter monitoring may be reduced to an annual frequency at the well.
- If two consecutive annual monitoring periods of post-treatment water quality monitoring at an OUCTP A-Aquifer well show both DO and ORP have returned to the approximate levels of recorded baseline conditions,¹³ then water quality parameter monitoring may be discontinued.

¹¹ As presented in the *Final OUCTP Remedial Action Work Plan, Former Fort Ord, California; Appendix A OUCTP A-Aquifer Remedial Design Addendum* (OUCTP RAWP RD Addendum; AES, 2014)

¹² As presented in the OUCTP RAWP RD Addendum (AES, 2014).

¹³ As presented in the OUCTP RAWP RD Addendum (AES, 2014).

- If sampling a well for VOC analyses has been discontinued in accordance with the decision rules for the GWMP, then discontinuing post-treatment water quality parameter monitoring may be considered on a case-by-case basis in consultation with the BCT.

Measurement of post-treatment groundwater quality parameters in an OUCTP A-Aquifer well may be reinstated or increased in frequency should conditions change in an adjacent well or immediately upgradient Deployment Area, including additional EISB treatment.

Completion of Groundwater Restoration Remedial Actions¹⁴

The decision rules for determining when groundwater remedial actions are complete in a particular site or OU, or a hydraulic zone within the site or OU, are:

- If data collected during the GWMP indicate potential uncertainties regarding the remedy's effectiveness and/or current site conditions, or potential key data gaps, then the conceptual site model will be re-evaluated and updated.
- If COC concentrations in a well are above ACLs, then the well and its respective hydraulic zone will remain in the remediation monitoring phase.¹⁵
- If four consecutive quarters of monitoring data show concentrations of COCs in a well are less than or equal to their respective ACLs, the well may be evaluated for completion of the remediation monitoring phase.
 - If non-statistical data review shows all COCs in the well are ND, all detected COC concentrations are less than or equal to the ACLs, or a combination of the two, then the remediation monitoring phase is complete in the well.
 - If groundwater monitoring data do not lend themselves to a non-statistical review, then statistical analysis of the data set may be used (e.g., mean test or trend test).
 - If the selected statistical method demonstrates the 95% upper confidence limit (UCL) value is equal to or less than the ACL for the COCs where statistical analysis was used, then the remediation monitoring phase is complete in the well.
- If a well has completed the remediation monitoring phase, then the well will enter the attainment monitoring phase.¹⁶
- If monitoring data show concentrations of COCs in a well are less than or equal to their respective ACLs, and it can be demonstrated COC concentrations will continue to be less than or

¹⁴ Adapted from EPA, 2014a and EPA, 2014b.

¹⁵ The remediation monitoring phase refers to the phase of the remedy where remedial activities are being implemented to reach groundwater cleanup levels selected in a remedy decision document. During this phase, groundwater sampling and monitoring data are collected to evaluate COC migration and changes in COC concentrations over time. The completion of this phase at a monitoring well typically occurs when the data collected and evaluated demonstrate that the groundwater has reached the cleanup levels for all COCs, as they are stated in the remedy decision document (EPA, 2013).

¹⁶ The attainment monitoring phase typically occurs after it is determined the remediation monitoring phase is complete. When the attainment phase begins, data are collected to evaluate if the well has reached post remediation conditions (i.e., steady state conditions) where remediation activities, if employed, are no longer influencing the groundwater in the well (EPA, 2013).

equal to ACLs in the future, then the attainment monitoring phase is complete under any of the following conditions.

- If all COCs in the well are ND, the LOQ is below the ACL, or a combination of ND sampling results and all detected COC concentrations are below the ACLs for eight consecutive sampling events, then a non-statistical or visual review of the COC data will be sufficient to conclude the attainment monitoring phase is complete in the well.
- If all COCs in the well are less than or equal to their respective ACLs for eight consecutive sampling events, and statistical analysis (i.e., trend analysis) demonstrates COCs will remain less than or equal to ACLs in the future (the trend line has a statistically significant zero [steady state] or negative [decreasing] slope, and the 95% UCL value is less than or equal to the ACL), then the attainment monitoring phase is complete in the well.
- If the well is removed from the sampling program in accordance with the decision rules applicable to GWMP decision rules presented above, then the attainment monitoring phase is complete in the well.
- If a well has completed the attainment monitoring phase and it is not needed for groundwater elevation data, then it will be proposed for decommissioning.
- If all the wells at a particular site or OU, or a hydraulic zone within the site or OU, have completed the attainment monitoring phase, then the attainment monitoring phase is complete for the particular site or OU, or hydraulic zone within the site or OU, and the decision rules for GWMP no longer apply (i.e., sampling for COC analysis may be discontinued and the wells may be proposed for decommissioning unless needed for groundwater elevation data).
- If the attainment monitoring phase is complete at all the hydraulic zones within a site or OU, then the site or OU will be proposed for closure in a remedial action completion report.

The decision rules for the GWMP and for Completion of Groundwater Restoration Remedial Actions will be implemented concurrently; however, the decision rules for determining when groundwater remedial actions are complete take precedence over the decision rules applicable to groundwater monitoring (e.g., if the attainment monitoring phase is complete at all wells in a hydraulic zone, then sampling for COC analysis is no longer necessary).

Exit strategy decision logic related to remedial process optimization and contingency measures (should the remedies not progress as expected) are presented in the *Final Technical Memorandum, Groundwater Remediation Exit Strategy, Sites 2/12 and OU2, Former Fort Ord, California* (MACTEC, 2009).

3.2.6 Step 6: Specify Performance or Acceptance Criteria

Sites 2/12 and OU2 GWTSs

The null hypotheses for the Sites 2/12 and OU2 GWTS are:

- 1) Concentrations of VOCs in groundwater entering the GWTS exist above the action levels
- 2) Concentrations of VOCs at the discharge points of compliance for the GWTS effluents are below discharge limits

The two types of decision errors that could result are a false acceptance decision error and a false rejection decision error. A false acceptance decision error for each null hypothesis would be to:

- 1) Assume a measured concentration is above the action level when in fact it is not.
- 2) Assume a measured concentration at a discharge point of compliance is below discharge limits when in fact it is not.

Consequences of the first false acceptance error might include unnecessarily treating groundwater that is not above action levels or continuation of remediation system operation after applicable ACLs have been met.

Consequences of the second false acceptance error might include delay of timely GAC change-out, resulting in discharge of water from the GWTS above discharge limits, or discontinuation of remediation system operation when applicable ACLs have not been met.

A false rejection error for each null hypothesis would be to:

- 1) Assume a measured concentration is not above the action level when in fact it is.
- 2) Assume a measured concentration at a discharge point of compliance is above the discharge limit when in fact it is not.

Consequences of the first false rejection error might include premature removal of extraction wells from the remediation system program before ACLs have been met.

Consequences of the second false rejection error might include unnecessarily performing or initiating confirmation sampling of GWTS effluent that actually met discharge limits during normal operation or remediation system shutdown, GAC change-out, and variance report issuance for effluent that met discharge limits after GAC vessel backwashing activities.

Decision errors are most likely to occur when the measured concentration is near the action level, or in the case of NDs, when the LOQ is near the action level. To control decision errors when the LOQ is near the action level, the laboratory is required to report any detections below the LOQ (but above the detection limit [DL]), thereby giving the data user additional information regarding trace level contamination. To control decision errors when the measured concentration is near the action level, the program is very conservative about making recommendations or changes based on individual sampling events and will require data from additional sampling or subsequent sampling events before modifying the treatment system network.

Sites 2/12, OU2, and OUCTP GWMP

VOCs in groundwater at the former Fort Ord range in concentration from ND to 14.1 micrograms per liter ($\mu\text{g/L}$) PCE (at Sites 2/12), 17.2 $\mu\text{g/L}$ TCE (at site OU2), and 6.3 $\mu\text{g/L}$ CT (at OUCTP), the primary COCs at these sites (as measured in the Third Quarter 2020 GWMP event).

The null hypothesis for this project is that concentrations of VOCs in groundwater exist above the action levels. A false acceptance decision (i.e., false positive decision error) would be to assume a measured concentration is above the action level, when in fact it is not. The consequences of this decision error

would be to incur unnecessary expense to study and potentially modify the monitoring network to address an extent of contamination that does not exist.

A false rejection decision error (i.e., false negative decision error) would be to assume a measured concentration is not above the action level when in fact it is. The consequences of this decision error would be to not study or potentially modify the monitoring network, thereby resulting in an incomplete understanding of the extent of contamination and the potential threat to groundwater quality.

Decision errors are most likely to occur when the measured concentration is near the action level, or in the case of NDs, when the LOQ is near the action level. To control decision errors when the LOQ is near the action level, the laboratory is required to report any detections below the LOQ (but above the DL), thereby giving the data user additional information regarding trace level contamination. To control decision error when the measured concentration is near the action level, the program is very conservative about making recommendations or changes based on individual monitoring events and will require data from additional sampling or subsequent sampling events before modifying the monitoring network.

In addition, trend analysis provides a valuable tool for assessing reliability of reporting concentrations. Furthermore, data are subjected to automated data review using an electronic system of QC checks, under the direction of a qualified chemist, using USACE and industry standards of analytical QC.

The null hypothesis is that EISB is not occurring in the Deployment Areas. A false acceptance decision (i.e., false positive decision error) would be to assume measured DO and ORP indicates there are no reducing conditions in the aquifer, when in fact there are. The consequences of this decision error would be to incur unnecessary expense to potentially perform additional EISB to establish reducing conditions in areas where they already exist.

A false rejection decision error (i.e., false negative decision error) would be to assume measured DO and ORP indicates there are reducing conditions in the aquifer, when in fact there are not. The consequences of this decision error would be to not perform additional EISB, thereby resulting in a longer period to achieve remedial action objectives.

Decision errors are most likely to occur when measured DO and ORP are near zero. To control such decision errors, the program is very conservative about making recommendations or changes based on individual monitoring events and will require data from additional sampling or subsequent sampling events before modifying the monitoring network. In addition, trend analysis provides a valuable tool for assessing reliability of reporting groundwater quality parameters.

3.2.7 Step 7: Develop the Plan for Obtaining Data

As a result of the DQO process, the optimum sampling design is derived for the Sites 2/12, OU2, and OUCTP remedies. Sample collection locations, rationales, and frequencies were established to achieve discharge compliance and provide a cost-effective means to evaluate the treatment of the impacted groundwater, and can be found in Worksheets #17a1 and #17a2 for Sites 2/12, and Worksheets #17b1 and #17b2 for OU2 and OUCTP. The EPA Method 8260-SIM (selected ion monitoring) analytical procedure for this project was selected to accurately quantify the chemicals of interest at the levels of

concern. Method performance criteria for EPA Method 8260-SIM are presented in Worksheets #24 and #28a.

The overall sampling network design is described in Worksheet #17c1 through #17c5.

Sampling design considerations regarding application of PDBs are described in the *Technical Memorandum Passive Diffusion Bag Pilot Study Results and Recommendations* (Harding ESE, 2001).

3.3 Worksheet #12: Measurement Performance Criteria

The measurement performance criteria (MPC) for chemical analyses being performed for each matrix and analytical parameter are summarized in the tables below in Worksheet #12. The MPCs follow those defined in the referenced EPA method or laboratory standard operating procedures (SOPs). The quality of the data to be collected for this project will be verified through appropriate MPCs established for both sampling procedures and analytical methods. The criteria relate to data quality indicators (DQIs) consisting of precision, accuracy, representativeness, comparability, completeness, and sensitivity, commonly referred to as PARCCS parameters. The DQIs are defined as follows:

- Precision refers to the reproducibility of measurements. Precision is usually expressed as standard deviation, variance, percent difference, or range, in either absolute or relative terms.
- Accuracy refers to the degree of agreement between an observed value (such as sample results) and an accepted reference value. A measurement is considered accurate when the reported value agrees with the true value or known concentration of the spike or standard within acceptable limits.
- Representativeness describes the extent to which a sampling design adequately reflects the environmental conditions of a site. Representativeness is determined by appropriate program design, with consideration of elements such as proper well locations, drilling and installation procedures, operations process locations, and sampling locations.
- Comparability addresses the degree to which different methods or data agree or can be represented as similar. Comparability is achieved by using standard methods (SM) for sampling and analysis, reporting data in standard units, normalizing results to standard conditions, and using standard and comprehensive reporting formats.
- Completeness is a measure of the amount of valid data collected using a measurement system. Completeness is expressed as a percentage of the number of measurements that are specified in this QAPP.
- Sensitivity is the ability of a method or instrument to detect the target analytes at the level of interest. Sensitivity can be measured by calculating the percent recovery of the analytes at the LOQ, which is the minimum concentration of an analyte that can be routinely identified and quantified above the method LOQ by a laboratory.

The quality of the sampling procedures and laboratory results will be evaluated for compliance with project DQOs through a review of overall PARCCS, in accordance with procedures described in Worksheet #37 (Data Usability Assessment). The results will be summarized in an overall data usability report.

3.3.1 Worksheet #12a: VOCs - Sites 2/12 and OU2 GWTS and Sites 2/12, OU2, and OUCTP GWMP

Analytical Group/Method: VOCs by EPA Method 8260-SIM

Matrix: Groundwater (µg/L)

S&A SOPs	DQIs	MPC	QC Sample or Activity Used to Assess MPC	QC Sample Assesses (S, A, or S&A)																																		
S: SOPs #1-5	Precision	RPD ≤ 30%	Field Duplicate	S																																		
A: SGS SOP#MS010.8		<table border="0"> <tr> <td><u>Analyte</u></td> <td><u>RPD</u></td> </tr> <tr> <td>All compounds</td> <td>≤ 20%</td> </tr> </table>	<u>Analyte</u>	<u>RPD</u>	All compounds	≤ 20%	8260-SIM: LCS/LCSD and MS/MSD	A																														
<u>Analyte</u>	<u>RPD</u>																																					
All compounds	≤ 20%																																					
A: SGS SOP#MS010.8	Accuracy / Precision	<table border="0"> <tr> <td><u>Analyte</u></td> <td><u>Recovery</u></td> </tr> <tr> <td>1,1-DCA</td> <td>77-125%</td> </tr> <tr> <td>1,1-DCE</td> <td>71-131%</td> </tr> <tr> <td>1,2-DCA</td> <td>73-128%</td> </tr> <tr> <td>1,2-DCE</td> <td>79-121%</td> </tr> <tr> <td>(total)</td> <td></td> </tr> <tr> <td>1,2,-DCPA</td> <td>78-122%</td> </tr> <tr> <td>1,3-DCPE</td> <td>77-123%</td> </tr> <tr> <td>(total)</td> <td></td> </tr> <tr> <td>Benzene</td> <td>79-120%</td> </tr> <tr> <td>CT</td> <td>72-136%</td> </tr> <tr> <td>Chloroform</td> <td>79-124%</td> </tr> <tr> <td>cis-1,2-DCE</td> <td>78-123%</td> </tr> <tr> <td>MC</td> <td>74-124%</td> </tr> <tr> <td>PCE</td> <td>74-129%</td> </tr> <tr> <td>TCE</td> <td>79-123%</td> </tr> <tr> <td>VC</td> <td>58-137%</td> </tr> </table>	<u>Analyte</u>	<u>Recovery</u>	1,1-DCA	77-125%	1,1-DCE	71-131%	1,2-DCA	73-128%	1,2-DCE	79-121%	(total)		1,2,-DCPA	78-122%	1,3-DCPE	77-123%	(total)		Benzene	79-120%	CT	72-136%	Chloroform	79-124%	cis-1,2-DCE	78-123%	MC	74-124%	PCE	74-129%	TCE	79-123%	VC	58-137%	8260-SIM: LCS and MS	A
<u>Analyte</u>		<u>Recovery</u>																																				
1,1-DCA	77-125%																																					
1,1-DCE	71-131%																																					
1,2-DCA	73-128%																																					
1,2-DCE	79-121%																																					
(total)																																						
1,2,-DCPA	78-122%																																					
1,3-DCPE	77-123%																																					
(total)																																						
Benzene	79-120%																																					
CT	72-136%																																					
Chloroform	79-124%																																					
cis-1,2-DCE	78-123%																																					
MC	74-124%																																					
PCE	74-129%																																					
TCE	79-123%																																					
VC	58-137%																																					
A: SGS SOP#MS010.8	Bias	<u>Analyte: Recovery</u> 1,2-Dichloroethane-d4: 81-118% Toluene-d8: 89-112%	8260-SIM: Surrogates	A																																		
S: SOPs #1-5 A: SGS SOP#MS010.8	Bias / Contamination	No analytes detected > ½ LOQ or > ⅓ the amount measured in any sample or > ⅓ the regulatory limit, whichever is greater. Common contaminants must not be detected > LOQ.	Method blank, field blank, trip blank	S&A																																		
S: SOPs #1-5	Representativeness	> 0°C ≤ 6°C	Cooler Temperature Blank	S																																		

S&A SOPs	DQIs	MPC	QC Sample or Activity Used to Assess MPC	QC Sample Assesses (S, A, or S&A)
		Samples preserved to pH < 2.0	Measure pH of samples after analysis	
S: SOPs #1-5 A: SGS SOP#MS010.8	Comparability	Reasonableness	Historical data	S&A
		Qualitative measure for field sampling procedures	LCS/LCSD and MS/MSD	A
S: SOPs #1-5	Completeness	≥ 95% field completeness	Number of samples collected out of total samples planned	S
A: SGS SOP#MS010.8		≥ 90% analytical completeness	Evaluation of number of unqualified ¹⁷ results out of the total results reported	A
A: SGS SOP#MS010.8	Sensitivity	Evidence of shift in instrument response or zero setting	LCS, ICAL, CCAL	A
		Limit of quantitation	LOQ studies	

Notes on next page.

¹⁷ Results qualified as estimated due to detected quantities between the LOQ and LOD will not be counted in the analytical completeness quantity assessment.

Notes:

<: less than

≤: less than or equal to

>: greater than

≥: greater than or equal to

%: percent

°C: degrees Celsius

CCAL: continuing calibration

1,1-DCA: 1,1-dichloroethane

1,1-DCE: 1,1-dichloroethene

1,2-DCA: 1,2-dichloroethane

1,2-DCE (total): total 1,2-dichloroethene

1,2-DCPA: 1,2-dichloropropane

1,3-DCPE: 1,3-dichloropropene

A: analytical

cis-1,2-DCE: cis-1,2-dichloroethene

CT: carbon tetrachloride

DL: detection limit

DQI: data quality indicator

ICAL: initial calibration

LCS: laboratory control samples

LCSD: laboratory control sample duplicate

LOQ: limit of quantitation

MC: methylene chloride

MPC: measurement performance criteria

MS: matrix spike

MSD: matrix spike duplicate

PCE: tetrachloroethene

QC: quality control

RPD: relative percent difference

S: sampling

S&A: sampling and analytical

SIM: selected ion monitoring

SOP: standard operating procedure

TCE: trichloroethene

trans-1,2-DCE: trans-1,2-dichloroethene

VOC: volatile organic compound

VC: vinyl chloride

3.3.2 Worksheet #12b: Metals - OU2 GWMP

Analytical Group: Metals by EPA Method 6010D

Matrix: Groundwater (µg/L)

S&A SOPs	DQIs	MPC	QC Sample or Activity Used to Assess MPC	QC Sample Assesses (S, A, or S&A)
S: SOP #3	Precision	RPD ≤ 30%	Field Duplicate	S
A: SGS SOP#MET 108.05		RPD ≤ 20%	LCS/LCSD and MS/MSD	A
A: SGS SOP#MET 108.05	Accuracy / Bias	MS and LCS: Antimony 88-113% Copper 86-114% Lead 86-113%	LCS and MS	A
S: SOP #3 A: SGS SOP#MET 108.05		The absolute values of all analytes must be < ½ LOQ or < ⅒ the amount measured in any sample or ⅒ the regulatory limit, whichever is greater.	Method blank and field blank	S&A
S: SOP #3	Representativeness	Samples preserved to pH < 2.0	Measure pH of samples upon receipt	S
		> 0°C ≤ 6°C	Cooler Temperature Blank	
S: SOP #3	Comparability	Reasonableness	Historical data	S
A: SGS SOP#MET 108.05		Qualitative measure for field sampling procedures	LCS/LCSD and MS/MSD	A
S: SOP #3	Completeness	≥ 95% field completeness	Number of samples collected out of total samples planned	S
A: SGS SOP#MET 108.05		≥ 90% analytical completeness	Evaluation of number of unqualified results out of the total results reported ¹⁸	A

¹⁸ Results qualified as estimated due to detected quantities between the LOQ and LOD will not be counted in the analytical completeness quantity assessment.

S&A SOPs	DQIs	MPC	QC Sample or Activity Used to Assess MPC	QC Sample Assesses (S, A, or S&A)
A: SGS SOP#MET 108.05	Sensitivity	Evidence of shift in instrument response or zero setting	LCS, ICAL, CCAL	A
		Limit of quantitation	LOQ studies	

Notes:

≤: less than or equal to

≥: greater than or equal to

A: analytical

°C: degrees Celsius

CCAL: continuing calibration

DL: detection limit

ICAL: initial calibration

LCS/LCSD: laboratory control sample/laboratory control sample duplicate

LOQ: limit of quantitation

MS/MSD: matrix spike/matrix spike duplicate

RPD: relative percent difference

S: sampling

S&A: sampling and analytical

SOP: standard operating procedure

3.3.3 Worksheet #12c: Wet Chemistry - Sites 2/12 GWTS and Sites 2/12 GWMP

Analytical Group: Chloride by EPA Method 9056A

Matrix: Groundwater (mg/L)

S&A SOPs	DQIs	MPC	QC Sample or Activity Used to Assess MPC	QC Sample Assesses (S, A, or S&A)
S: SOPs #3&5	Precision	RPD \leq 30%	Field Duplicate	S
A: SGS SOP#GN228.10 /ORLD_WET-237-00-SOPT-IC_Metrohm		<u>Analyte</u> <u>RPD</u> Chloride \leq 20%	Laboratory duplicates and MS/MSD (chloride only)	A
A: SGS SOP#GN228.10 /ORLD_WET-237-00-SOPT-IC_Metrohm	Accuracy / Bias	<u>Analyte</u> <u>Recovery</u> Chloride 90-110%	LCS and MS	A
S: SOPs #3&5 A: SGS SOP#GN228.10 /ORLD_WET-237-00-SOPT-IC_Metrohm		No analytes detected $> \frac{1}{2}$ LOQ or $> \frac{1}{10}$ the amount measured in any sample or $> \frac{1}{10}$ the regulatory limit, whichever is greater. Common contaminants must not be detected $>$ LOQ.	Method blank and field blank	S&A
S: SOPs #3&5	Representativeness	$> 0^{\circ}\text{C} \leq 6^{\circ}\text{C}$	Cooler Temperature Blank	S
S: SOPs #3&5	Comparability	Reasonableness	Historical data	S
A: SGS SOP#GN228.10 /ORLD_WET-237-00-SOPT-IC_Metrohm		Qualitative measure for field sampling procedures	LCS/LCSD and MS/MSD	A
S: SOPs #3&5	Completeness	\geq 95% field completeness	Number of samples collected out of total samples planned	S
A: SGS SOP#GN228.10 /ORLD_WET-237-00-SOPT-IC_Metrohm		\geq 90% analytical completeness	Evaluation of number of unqualified results out of the total	A

S&A SOPs	DQIs	MPC	QC Sample or Activity Used to Assess MPC	QC Sample Assesses (S, A, or S&A)
			results reported ¹⁹	
A: SGS SOP#GN228.10 /ORLD_WET- 237-00-SOPT- IC_Metrohm	Sensitivity	Evidence of shift in instrument response or zero setting	LCS, ICAL, CCAL	A
		Limit of quantitation	LOQ studies	

Notes:

≤: less than or equal to

≥: greater than or equal to

A: analytical

°C: degrees Celsius

CCAL: continuing calibration

ICAL: initial calibration

DL: detection limit

LCS/LCSD: laboratory control sample/laboratory control sample duplicate

LOQ: limit of quantitation

MS/MSD: matrix spike/matrix spike duplicate

RPD: relative percent difference

S: sampling

S&A: sampling and analytical

SOP: standard operating procedure

¹⁹ Results qualified as estimated due to detected quantities between the LOQ and LOD will not be counted in the analytical completeness quantity assessment.

3.4 Worksheet #13: Secondary Data Uses and Limitations

Since the groundwater sampling activities for the Sites 2/12 and OU2 GWTS and the Sites 2/12, OU2, and OUCTP GWMP are both long-term remedial action and monitoring programs and not active investigative programs, the secondary data that will be used to evaluate performance and concentration trends for both programs consist of the most recent annual monitoring reports as listed below. Secondary data and information that will be used, including originating sources, are identified below. How the secondary data will be used and the limitations on their uses are specified. Data from these documents will be used as appropriate.

Data Source	Data Generator	How Data Will be Used	Limitations on Data Use
<i>Draft Sites 2 and 12 Fourth Quarter 2019 through Third Quarter 2020 Groundwater and Soil Gas Monitoring and Treatment System Report, Former Fort Ord, California (Ahtna, 2021a)</i>	Ahtna	Historical data used to evaluate GWTS performance over time	None
<i>Draft Operable Unit 2 Remedy Monitoring and Operations and Maintenance Fourth Quarter 2019 through Third Quarter 2020, Former Fort Ord, California (Ahtna, 2021b)</i>	Ahtna	Historical data used to evaluate GWTS performance over time	None
<i>Draft Operable Unit Carbon Tetrachloride Plume Fourth Quarter 2019 through Third Quarter 2020 Groundwater Monitoring Report, Former Fort Ord, California (Ahtna, 2021c)</i>	Ahtna	Historical data used to evaluate concentration trends	None

3.5 Worksheets #14 and #16: Project Tasks & Schedule

3.5.1 Project Tasks

Applicable SOP(s) for the project tasks outlined in this Worksheet are listed in Worksheet #21 and provided in detail in Attachment A. The sampling tasks are described in Worksheets #17 and #18.

3.5.2 Waste and Equipment Decontamination

Wastewater generated during decontamination will be disposed of at the Sites 2/12 or OU2 GWTS and treated with the influent groundwater. Personal protective equipment and miscellaneous waste will be placed in large garbage bags, sealed, and disposed of in facility trash receptacles.

3.5.3 Quality Control Tasks

Field SOPs will be implemented and field QC samples will be collected at the frequency indicated in Worksheet #20. Samples will be analyzed by the laboratory in accordance with this QAPP, DoD QSM, and the stated method. For items related to QC, see Worksheets #11, #12, #15, #22, #24, #25, #27, and #28.

3.5.4 Secondary Data

See Worksheet #13.

3.5.5 Data Management Tasks

The following are the team members and their responsibilities for the data management process:

Task Manager. Responsible for reviewing chain of custody forms and establishing the sample tracking system. Oversees proper use of Ahtna's sample management system and accuracy of the information entered. Reviews laboratory data for accuracy and quality and compares electronic outputs for accuracy to laboratory electronic copies. Conducts tracking of samples, forwards tracking information and received data to the Database Manager, and identifies the data inputs (for example, sample numbers) to use in generating tables and figures.

Database Manager. Responsible for setting up the data management system in consultation with the Project Chemist/Task Manager at the beginning of the data evaluation task. Oversees the data management process, including data conversion/manual entry into the data management system, QC of the entered data, and preparation of the required tables and plots of the data. Coordinates with the person responsible for reviewing the entered data for QC purposes. Forwards all deliverables to the Project Manager.

Geographic Information System (GIS) Manager. Responsible for coordinating with the Project Manager to set up the geodatabase prior to sampling. Maintains spatial layers and overall geodatabase integrity and accuracy. Provides all GIS-related outputs for reports.

3.5.6 Sample Tracking

The Task Manager is responsible for tracking samples in the sample tracking database to ensure that the analytical results for all samples sent for analysis are received. Copies of chains of custody from the field

team are used to enter in sample identifications (IDs), collect data, and for analyses. Upon receipt of a sample receipt notice from the laboratory, the date received by the laboratory, and a date the electronic copy is due will be entered. Likewise, upon receipt of the electronic copy and electronic data deliverable (EDD), the date they are received will also be entered. The EDDs will be uploaded when received from the laboratory and will be tracked in the sample tracking table. Validation qualifiers will be added to the database and results qualified accordingly.

3.5.7 Data Types

The data will be added to the project database as they become available. The data will include new data collected in the laboratory and validated by Ahtna. The data source will be noted in the database.

3.5.8 Data Tracking and Management

Every data set received from analytical laboratories will be tracked individually. Analytical laboratory reports of chemical analysis results will be tracked in a consistent fashion. Every data set will be assigned a unique identifier. The date of receipt, status of data validation, and status of database entry for each data set will all be tracked and recorded in the project database.

Hard/Electronic Copy. Measurements made during field data collection activities will be recorded in field logbooks and sample processing logs. Field data will be reduced and summarized, tabulated, and stored along with the field logbooks and sample processing logs. All raw analytical laboratory data are stored electronically.

Data Input Procedures. Sampling information, analytical results, applicable QA/QC data, data validation qualifiers, and other field-related information will be entered into the project database for storage and retrieval during data evaluation and report development. The analytical data will be loaded into the database using EDD files received from the analytical laboratory. Validation qualifiers will be entered manually. Other available field-related data collected will be manually entered onto standard EDD templates for loading into the database. Historical data, either in hard copy or electronic form, will be manually entered on or formatted to standard EDD templates for database loading.

3.5.9 Computer Database

The technical data, field observations, laboratory analytical results, and analytical data validation will be managed using Ahtna's database (EQuIS™) to store and analyze project data submissions. EQuIS™ is a front-end user interface for data management using a back-end SQL Server™ database. Servers that house the database are stored and managed by Earthsoft, Inc. Secure database access is performed through EQuIS™ or SQL Server Management Studio software. Data validation is performed by Laboratory Data Consultants, Inc. and validation information is ultimately stored in the EQuIS™ database.

Access and privileges are provided to database support staff on an as-needed basis by the Ahtna Data Manager. This protects the database from unauthorized access and any data modification. Privileges may range from read-only to loading, modifying, or querying the database.

Backups of the primary database are performed by Earthsoft, Inc. to ensure no data loss.

In addition to the internal computer database, EDDs will be uploaded to the BRAC Fort Ord Data Integration System (FODIS) database and the CCRWQCB GeoTracker database (as required).

3.5.10 Geographic Information System Description

A project geodatabase will be set up prior to sampling by the Task Manager and GIS Manager. Ahtna will adhere to all applicable federal, DoD, and Army geospatial data standards for tasks and deliverables in this QAPP and will meet the minimum requirements for spatial data in accordance with Spatial Data Standards for Facilities, Infrastructure, and Environment, current version whenever possible. Ahtna will submit the native GIS files that will include map data (.mxd) and geodatabase (.dbf) format. Ahtna will provide validated geospatial data to USACE for submission by BRAC to the FODIS database.

Each geospatial data set shall be accompanied by metadata conforming to the Federal Geographic Data Committee Content Standard for Digital Geospatial Metadata and the Army Installation Geospatial Information & Services Metadata Standard, v1. The horizontal accuracy of any geospatial data created shall be tested and reported in accordance with the National Standard for Spatial Data Accuracy and the results shall be recorded in the metadata. All data will have a datum of GCS_North American_1983 and a projection of North American Datum 1983 State Plane California Zone 4. The sea level datum used will be the National Geodetic Vertical Datum 1929 to conform with historical former Fort Ord data.

In addition to laboratory data, other physical data will be collected during field efforts. The information will be stored in the project database. Other types of data elements may be added as the field investigation needs and activities evolve.

3.5.11 Data Management Documentation

Documentation of data management activities is critical because it demonstrates that data is being managed in a consistent and organized fashion. EQUIS™ software developed by Earthsoft, Inc. is an industry standard for the management of environmental data. EQUIS software is the user interface that accesses data stored in a SQL Server database. This database is managed and housed by Earthsoft. All SQL Server updates, database backups, and customer support are provided to Ahtna by Earthsoft. Earthsoft also has an extensive community group and documentation regarding their application.

3.5.12 Presentation of Data

Depending on data user needs, data presentation may consist of any of the following formats:

- Tabulated results of data summaries or raw data
- Figures showing concentration isopleths or location-specific concentrations
- Tables providing statistical evaluation or calculation results
- Presentation tools, such as ArcMap or similar analysis/presentation aids

In addition to laboratory data, other physical data will be collected during field efforts. The information will be stored in the project database. Other types of data elements may be added as the field investigation needs and activities evolve.

3.5.13 Assessment and Audit Tasks

See Worksheets #31, #32, and #33.

3.5.14 Data Review Tasks

The laboratory will make sure that the data are complete for all samples received. Laboratory data will be validated by Laboratory Data Consultants, Inc. Validated data and field logs will be reviewed to assess total measurement error and determine the overall usability of the data for project purposes. Final data are placed in the database with qualifiers. See Worksheets #34 through #37 for the tasks.

3.5.15 Documentation and Records

Records and field measurements of all samples will be collected in notebooks. Chains of custody and sample logs will be prepared and retained for each sample. A copy of the final QAPP will be kept at the Ahtna OU2 GWTP field office. Field forms are shown in Attachment B.

3.5.16 Project Schedule

A general project schedule for long-term monitoring is presented below.

Activity	Responsible Party	Frequency	Deliverable(s)	Deliverable Due Date
OU2 GWTS O&M	Ahtna	Ongoing	Quarterly and Annual Reports	Quarterly Report (Final only) due 60 days after sampling event concludes*
Sites 2/12 GWTS O&M				
OU2 GWMP		Quarterly		Annual Report (Pre-Draft) due 60 days after sampling event concludes*
Sites 2/12 GWMP				
OUCTP GWMP				

Notes:

* The conclusion of the sampling event is defined as the last day samples are collected for the event.

3.6 Worksheet #15: Laboratory-Specific Detection/Quantitation Limits

3.6.1 Worksheet #15a: VOCs by EPA Method 8260-SIM

Matrix: Groundwater (µg/L)

Analyte	CAS #	Project Action Limits ¹ (µg/L)								Achievable Laboratory Limits ³ (µg/L)		
		Sites 2/12		OU2		OUCTP			DL	LOD	LOQ	
						A-Aquifer	Upper 180-Foot Aquifer	Lower 180-Foot Aquifer				
		ACL	DCL ⁴	ACL	DCL	ACL	ACL	DCL	ACL			
1,1-Dichloroethane	75-34-3	-	-	5	5 ⁵	-	-	-	-	0.10	0.25	0.50
1,1-Dichloroethene	75-35-4	6	6	-	-	6	-	-	-	0.10	0.25	0.50
1,2-Dichloroethane	107-06-2	0.5	0.5	0.5	0.5	-	-	-	0.5	0.10	0.25	0.50
1,2-Dichloroethene (total) ⁶	540-59-0	-	-	-	-	6	-	-	-	0.10	0.25	0.50
1,2-Dichloropropane	78-87-5	-	-	1	0.5	-	-	-	-	0.10	0.25	0.50
1,3-Dichloropropene (total) ⁶	542-75-6	0.5	0.5	-	-	-	-	-	-	0.10	0.25	0.50
Benzene	71-43-2	-	-	1	0.5	-	-	-	-	0.10	0.25	0.50
Carbon Tetrachloride	56-23-5	-	-	0.5	0.5	0.5	0.5	0.5	0.5	0.10	0.25	0.50
Chloroform	67-66-3	2	2	2	2 ⁵	2	-	-	-	0.10	0.25	0.50
cis-1,2-Dichloroethene	156-59-2	6	6	6	6 ⁵	-	-	-	-	0.10	0.25	0.50
Methylene chloride	75-09-2	-	-	5	0.5	5	-	-	-	0.50	0.50	2.0
Tetrachloroethene	127-18-4	5	5	3	0.5	5	-	-	-	0.10	0.25	0.50
Trichloroethene	79-01-6	5	5	5	0.5	5	-	-	-	0.10	0.25	0.50
Vinyl Chloride	75-01-4	0.1	0.1	0.1	0.1	0.1	-	-	-	0.050	0.050	0.10

Notes on next page.

Notes:

µg/L: micrograms per liter

ACL: Aquifer Cleanup Level

CAS #: Chemical Abstracts Service Number

DCL: discharge limit

DL: detection limit

LOD: limit of detection

LOQ: limit of quantitation

OU: Operable Unit

OUCTP: Operable Unit Carbon Tetrachloride Plume

-: not applicable

¹ACLs and discharge limits are site-specific and identified in the relevant decision documents (Army, 1994; Army, 1995, Army, 1997; Army, 2008; and Army, 2016).

²Analytical method DLs, LODs and LOQs are those documented in published methods.

³Achievable DLs, LODs, and LOQs are limits that an individual laboratory can achieve when performing a specific analytical method. An analyte is ND at the LOD, and a measurable detection above the DL and less than the LOQ is estimated (“J-qualified”).

⁴Discharge limit for the applicable groundwater treatment system using groundwater extraction and treatment with GAC. For Sites 2/12 GWTS, discharge to areas overlying the contaminated groundwater plume need only meet ACLs (HLA, 1999).

⁵Discharge limit revised to ACL for this COC to optimize GAC usage (HLA, 1999).

⁶Total of cis- and trans- isomers.

3.6.2 Worksheet #15b: Ion Chromatography by EPA Method 9056A

Matrix: Groundwater (mg/L)

Analyte	CAS Number	Project Action Limits ¹ (mg/L) Sites 2/12	Achievable Laboratory Limits ³ (mg/L)			
			DL	DL	LOD	LOQ
Chloride	16887-00-6	250	0.02	0.80	1.0	2.0

Notes:

CAS: Chemical Abstracts Service

DL: detection limit

LOD: limit of detection

LOQ: limit of quantitation

mg/L: milligrams per liter

¹Project Action Limits are National Secondary MCLs for Drinking Water Quality.

²Analytical method DLs, LODs and LOQs are those documented in published methods.

³Achievable DLs, LODs, and LOQs are limits that an individual laboratory can achieve when performing a specific analytical method. An analyte is ND at the LOD, and a measurable detection above the DL and less than the LOQ is estimated (“J-qualified”).

3.6.3 Worksheet #15c: Dissolved Metals by ICP by EPA Method 6010D

Matrix: Groundwater (µg/L)

Analyte	CAS Number	Project Action Limits ¹ (µg/L) OU2	Achievable Laboratory Limits ³ (µg/L)		
			DL	LOD	LOQ
Antimony	7440-36-0	6.0	1.0	5.0	6.0
Copper	7440-50-8	1,000	1.0	2.0	25
Lead	7439-92-1	15	1.1	2.0	5.0

Notes:

CAS: Chemical Abstracts Service

DL: detection limit

LOD: limit of detection

LOQ: limit of quantitation

µg/L: micrograms per liter

¹Project Action Limits are state or federal MCLs (whichever is lower) for drinking water in OU2 wells associated with the Fort Ord Landfills. Antimony, copper, and lead are the primary metals found in spent ammunition deposited in the Fort Ord Landfills. MCLs are used to evaluate concentrations of these dissolved metals in groundwater near the Fort Ord Landfills; however, the groundwater being monitored is not intended for use as drinking water.

²Analytical method DLs, LODs and LOQs are those documented in published methods.

³Achievable DLs, LODs, and LOQs are limits that an individual laboratory can achieve when performing a specific analytical method. An analyte is ND at the LOD, and a measurable detection above the DL and less than the LOQ is estimated (“J-qualified”).

4.0 Sample Design

4.1 Worksheet #17: Sampling Design and Rationale

A summary of existing monitoring locations is listed in the Worksheets below, separated by site and aquifer accordingly.

4.1.1 Worksheet #17a1: Sites 2/12 GWTS Part I

Sampling Location	Activity	EPA Method	Comments/Rationale ⁴	SOP Reference
TS-212-INF	GWTS monitoring ¹	8260-SIM	To measure influent COC concentrations and evaluate GWTS efficiency.	SOP #5
TS-212-GAC A			To measure COC concentrations downstream from the GAC vessel and evaluate GAC efficiency.	
TS-212-EFF			To measure COC concentrations downstream from the air stripper unit and evaluate air stripper efficiency.	
TS-212-INJ			To comply with discharge limits.	
EW-12-03-180U ⁶	Groundwater Monitoring ²	8260-SIM EPA Method 9056A SM 9056A	To measure changes in groundwater COC concentrations. To evaluate general inorganic constituents.	
EW-12-03-180M ⁵				
EW-12-04-180U ⁶				
EW-12-04-180M ⁶				
EW-12-05-180M ³				
EW-12-07-180M ³				
EW-12-08-180U ³				

Notes:

COC: chemical of concern

EFF: effluent

EW: extraction well

GAC: granular activated carbon

INF: influent

INJ: injection

TS: treatment system sampling port

SOP: standard operating procedure

¹ The sampling frequency is variable based on historical GAC breakthrough rates, as shown on Worksheet #17a2.

² Samples and water level measurements are collected quarterly or annually from the extraction wells based on the decision rules identified in Worksheet #10a.

³ During the 3rd Quarter (Annual) sampling event, chloride is analyzed.

⁴ The rationale for sampling locations and frequency is based on the RI Sites ROD and RI Sites ESD, program history and precedent established by the BCT, which includes the Army, USACE, EPA, DTSC, and CCRWQCB.

⁵ Pump removed from the inoperable extraction well, groundwater sampling conducted with PDBs as identified in Worksheet #17c.

⁶ Well no longer sampled per decision rules (Worksheet #10a).

4.1.2 Worksheet #17a2: Sites 2/12 GWTS Part II

The *Final Operations and Maintenance Manual Volume II, Sites 2 and 12 Groundwater Remedy, Former Fort Ord, California* (Sites 2/12 GWTS O&M Manual; AES, 2009) provides procedures for O&M of the Sites 2/12 GWTS. The Sites 2/12 GWTS O&M Manual also describes the conditions required for GAC change-out in Section 4.2.3, but those instructions are superseded by Worksheet #17a2.

Sites 2/12 GWTS Sampling Frequencies ³									
Sample Point	Weeks after GAC change-out ⁴								
	0	12	21	30	36	42	44	46	48 ⁴
TS-212-INF			xx		x	xx	x	xx	x
TS-212-GAC-A ¹	x ²		x	x	x	x	x	x	x
TS-212-EFF						x	x	x	x
TS-212-INJ		x	x	x	x	x	x	x	x

Notes:

≥: greater than or equal to

=: percent

x: sample collected

xx: sample and duplicate collected

¹ Sample point immediately downstream of the GAC vessel.

² Sample collected no less than 2 hours after bringing a newly repacked GAC vessel online.

³ The sampling frequency is determined based on historical COC breakthrough rates; however, the sampling frequency may be altered if there are significant operational changes.

⁴ If GAC change-out is not indicated by Week 48, further sampling will be performed weekly, or at a frequency determined by the Project Manager, until GAC effluent PCE or TCE concentration is ≥ 90% of the discharge limit.

4.1.3 Worksheet #17b1: OU2 GWTS Part I

Sampling Location	Activity	Test Methods	Comments/Rationale ³	SOP Reference
TS-OU2-INF-01*	GWTS Monitoring ¹	EPA Method 8260-SIM	To measure influent COC concentrations and evaluate GWTS efficiency.	SOP #5
TS-OU2-INF-02*				
TS-OU2-EFF-1A*				
TS-OU2-EFF-1B*				
TS-OU2-EFF-1C*				
TS-OU2-EFF-2A*				
TS-OU2-EFF-2B*				
TS-OU2-EFF-2C*				
TS-OU2-INJ-01*			To measure COC concentrations downstream from the GAC vessels. To comply with discharge limits (point of compliance).	
EW-OU2-01-A ⁵	Groundwater Monitoring ²	EPA Method 8260-SIM	To evaluate changes in groundwater COC concentrations.	SOP #5
EW-OU2-02-A				
EW-OU2-03-A ⁵				
EW-OU2-04-A				
EW-OU2-05-A				
EW-OU2-06-A				
EW-OU2-07-A ⁵				
EW-OU2-09-A				
EW-OU2-10-A				
EW-OU2-11-AR				
EW-OU2-12-A				
EW-OU2-13-A				
EW-OU2-16-A				
EW-OU2-17-A				
EW-OU2-18-A				
EW-OU2-19-A				
EW-OU2-20-A				
EW-OU2-01-180 ⁴				
EW-OU2-02-180R				
EW-OU2-03-180				
EW-OU2-04-180 ⁵				
EW-OU2-05-180				
EW-OU2-06-180				
EW-OU2-07-180 ⁴				
EW-OU2-08-180				
EW-OU2-09-180 ⁶				
EW-OU2-10-180				

Sampling Location	Activity	Test Methods	Comments/Rationale ³	SOP Reference
EW-OU2-11-180	Groundwater Monitoring ²	EPA Method 8260-SIM	To evaluate changes in groundwater COC concentrations.	
EW-OU2-12-180				

Notes:

COC: chemical of concern

EFF: effluent

EW: extraction well

GAC: granular activated carbon

INF: influent

INJ: injection

TS: treatment system sampling port

¹ The sampling frequency is variable based on historical GAC breakthrough rates, as shown in Worksheet #17b2.

² Groundwater samples and water level measurements are collected quarterly or annually from the extraction wells based on the decision rules identified in Worksheet #10a.

³ The rationale for sampling locations and frequency is based on the OU2 ROD, OU2 ESD, program history and precedent established by the BCT, which includes the Army, USACE, EPA, DTSC, and CCRWQCB.

⁴ Pump removed from the inoperable extraction well, groundwater sampling conducted with PDBs as identified in Worksheet #17c5.

⁵ Well no longer sampled per decision rules (Worksheet #10).

⁶ Well operated to remediate the OUCTP Upper 180-Foot Aquifer as listed in Worksheet #17c4.

* The OU2 GWTP sampling locations were renamed as listed below.

<u>New Name</u>	<u>Former Name</u>
TS-OU2-INF-01	SP-IN-01
TS-OU2-INF-02	SP-IN-02
TS-OU2-EFF-1A	SP-1A-EF
TS-OU2-EFF-1B	SP-1B-EF
TS-OU2-EFF-1C	SP-1C-EF
TS-OU2-EFF-2A	SP-2A-EF
TS-OU2-EFF-2B	SP-2B-EF
TS-OU2-EFF-2C	SP-2C-EF
TS-OU2-INJ-01	SP-EF-01

4.1.4 Worksheet #17b2: OU2 GWTS Part II

The OU2 GWTP O&M Manual (JV, 2019) provides procedures for sampling of the OU2 GWTP and describes the conditions required for GAC change-out, but those instructions are superseded by Worksheet #17b2.

OU2 GWTS Sampling Frequencies ^{3,4} Median GAC Cycle to be determined ⁵														
Sampling Point	GAC change-out	Weeks after GAC change-out ⁶												
		0	1	2	3	4	5	9	13	16	19	22	24	26
TS-OU2-INF-01		x	x	xx	x	x	x	xx		x		xx		x
TS-OU2-INF-02		xx	x	x	x	xx	x			xx		x		xx
TS-OU2-EFF-1A ¹		x	x	x	x	x	x			x	X	x	x	x
TS-OU2-EFF-1B ¹		x								x		x		x
TS-OU2-EFF-1C ¹		x								x		x		x
TS-OU2-EFF-2A ¹		x	x	x	x	x	x			x	X	x	x	x
TS-OU2-EFF-2B ¹		x								x		x		x
TS-OU2-EFF-2C ¹		x								x		x		x
TS-OU2-INJ-01	x ²	x	x	x	x	x	x	x	x	x	X	x	x	x

Notes:

- TS-OU2-INF-01 (formerly SP-IN-01) = Eastern Main influent
- TS-OU2-INF-02 (formerly SP-IN-02) = Western Main influent
- TS-OU2-EFF-1A (formerly SP-1A-EF) = GAC 1A effluent
- TS-OU2-EFF-1B (formerly SP-1B-EF) = GAC 1B effluent
- TS-OU2-EFF-1C (formerly SP-1C-EF) = GAC 1C effluent
- TS-OU2-EFF-2A (formerly SP-2A-EF) = GAC 2A effluent
- TS-OU2-EFF-2B (formerly SP-2B-EF) = GAC 2B effluent
- TS-OU2-EFF-2C (formerly SP-2C-EF) = GAC 2C effluent
- TS-OU2-INJ-01 (formerly SP-EF-01) = discharge point of compliance
- x: sample collected
- xx: sample and duplicate collected
- ¹ Sample point to be immediately downstream of the lead GAC vessel.

² Sample collected no less than 2 hours after bringing a newly repacked GAC vessel online.

³ The sampling frequency is determined based on historical COC breakthrough rates at the old OU2 GWTP; however, the sampling frequency may be altered at the discretion of the Project Manager if there are significant differences in operational conditions at the new OU2 GWTP.

⁴ The sampling schedule assumes vessels GAC 1A and GAC 2A are in the lead position.

⁵ The median GAC cycle for the new OU2 GWTP is based on analytical results for process samples collected during the first year of operation.

⁶ If GAC change-out is not indicated by Week 26, further sampling will be performed weekly or at a frequency determined by the direction of the Project Manager.

4.1.5 Worksheet #17c1: Sites 2/12 GWMP

Well Name	CI	VOCs (8260-SIM)	Water Levels	Sampling Methods/SOP	Rationale ¹
EW-12-03-180M		Q	Q	PDB/SOP #2	RI Sites ROD/ESD
EW-12-05-180M	A	Q	Q	Pump Spigot/SOP #5	RI Sites ROD/ESD
EW-12-07-180M	A	Q	Q	Pump Spigot/SOP #5	RI Sites ROD/ESD
EW-12-08-180U	A	Q	Q	Pump Spigot/SOP #5	RI Sites RI/FS Addendum
MW-02-13-180M	A	Q	Q	HydraSleeve™, PDB/ SOP #3,2	RI Sites ROD/ESD
MW-12-01-180		A	Q	PDB/SOP #2	RI Sites ROD/ESD
MW-12-09R-180		Q	Q	PDB/SOP #2	RI Sites ROD/ESD
MW-12-14-180M		Q	Q	PDB/SOP #2	RI Sites ROD/ESD
MW-12-15-180M		Q	Q	PDB/SOP #2	RI Sites ROD/ESD
MW-12-16-180M		Q	Q	PDB/SOP #2	RI Sites ROD/ESD
MW-12-20-180U		Q	Q	PDB/SOP #2	RI Sites ROD/ESD
MW-12-21-180U		Q	Q	PDB/SOP #2	RI Sites ROD/ESD
MW-12-22-180U		Q	Q	PDB/SOP #2	RI Sites ROD/ESD
MW-12-24-180U		Q	Q	PDB/SOP #2	RI Sites ROD/ESD
MW-12-28-180U		Q	Q	PDB/SOP #2	RI Sites ROD/ESD
MW-12-29-180U		A	Q	PDB/SOP #2	RI Sites ROD/ESD
MW-12-30-180U		Q	Q	PDB/SOP #2	RI Sites ROD/ESD
MW-12-32-180U		Q	Q	PDB/SOP #2	RI Sites ROD/ESD
The Following Wells Are Measured for Groundwater Elevation Data Only:					
EW-12-03-180U			Q	SOP #5	Groundwater elevation trend analysis
EW-12-04-180M			Q	SOP #5	Groundwater elevation trend analysis
EW-12-04-180U			Q	SOP #5	Groundwater elevation trend analysis
MW-02-05-180			Q	SOP #5	Groundwater elevation trend analysis
MW-02-06-180			Q	SOP #5	Groundwater elevation trend analysis
MW-02-10-180			Q	SOP #5	Groundwater elevation trend analysis
MW-02-13-180U			Q	SOP #5	Groundwater elevation trend analysis
MW-12-05-180			Q	SOP #5	Groundwater elevation trend analysis
MW-12-07-180			Q	SOP #5	Groundwater elevation trend analysis

Well Name	Cl	VOCs (8260-SIM)	Water Levels	Sampling Methods/SOP	Rationale ¹
MW-12-08-180			Q	SOP #5	Groundwater elevation trend analysis
MW-12-12-180L			Q	SOP #5	Groundwater elevation trend analysis
MW-12-17-180U			Q	SOP #5	Groundwater elevation trend analysis
MW-12-18-180U			Q	SOP #5	Groundwater elevation trend analysis
MW-12-19-180U			Q	SOP #5	Groundwater elevation trend analysis
MW-12-19-180M			Q	SOP #5	Groundwater elevation trend analysis
MW-12-23-180U			Q	SOP #5	Groundwater elevation trend analysis
MW-12-25-180U			Q	SOP #5	Groundwater elevation trend analysis
MW-12-26-180U			Q	SOP #5	Groundwater elevation trend analysis
MW-12-27-180U			Q	SOP #5	Groundwater elevation trend analysis
MW-12-31-180M			Q	SOP #5	Groundwater elevation trend analysis

Notes:

A: sampled on an annual basis

Cl: chloride

ESD: Explanation of Significant Differences

PDB: passive diffusion bag

Q: sampled on a quarterly basis

RI: Remedial Investigation

RI/FS: Remedial Investigation/Feasibility Study

ROD: Record of Decision

SIM: selected ion monitoring

SOP: standard operating procedure

VOCs: volatile organic compounds

¹The rationale for sampling locations and frequency is based on the applicable program RODs, ESDs, program history, and precedent established by the BCT, which includes the Army, USACE, EPA, DTSC, and CCRWQCB.

4.1.6 Worksheet #17c2: OU2 GWMP

Well Name	Cu, Pb, Sb (6010D)	VOCs (8260-SIM)	Water Levels	Sampling Methods/SOP	Rationale ¹
EW-OU2-01-180		Q	Q	PDB/SOP #2	OU2 ESD
EW-OU2-02-180R		Q	Q	Pump Spigot/SOP #5	OU2 GWTP Relocation
EW-OU2-02-A		Q	Q	Pump Spigot/SOP #5	OU2 ROD
EW-OU2-03-180		Q	Q	Pump Spigot/SOP #5	OU2 ROD
EW-OU2-04-A		Q	Q	Pump Spigot/SOP #5	OU2 ROD
EW-OU2-05-180		Q	Q	Sampling Port/SOP #2	OU2 ROD
EW-OU2-05-A		Q	Q	Pump Spigot/SOP #5	OU2 ROD
EW-OU2-06-180		Q	Q	Pump Spigot/SOP #5	OU2 ROD
EW-OU2-06-A		Q	Q	Pump Spigot/SOP #5	OU2 ROD
EW-OU2-08-180		Q	Q	Pump Spigot/SOP #5	OU2 ROD
EW-OU2-09-A		Q	Q	Pump Spigot/SOP #5	OU2 ROD
EW-OU2-10-180		Q	Q	Pump Spigot/SOP #5	OU2 GWTP Relocation
EW-OU2-10-A		Q	Q	Pump Spigot/SOP #5	OU2 GWTP Relocation
EW-OU2-11-180		Q	Q	Pump Spigot/SOP #5	OU2 GWTP Relocation
EW-OU2-11-AR		Q	Q	Pump Spigot/SOP #5	OU2 GWTP Relocation
EW-OU2-12-180		Q	Q	Pump Spigot/SOP #5	OU2 GWTP Relocation
EW-OU2-12-A		Q	Q	Pump Spigot/SOP #5	OU2 ROD
EW-OU2-13-A		Q	Q	Pump Spigot/SOP #5	OU2 ROD
EW-OU2-15-A		Q	Q	PDB/SOP #2	OU2 ESD
EW-OU2-16-A		Q	Q	Pump Spigot/SOP #5	OU2 ROD
EW-OU2-17-A		Q	Q	Pump Spigot/SOP #5	OU2 GWTP Relocation
EW-OU2-18-A		Q	Q	Pump Spigot/SOP #5	OU2 GWTP Relocation
EW-OU2-19-A		Q	Q	Pump Spigot/SOP #5	OU2 GWTP Relocation
EW-OU2-20-A		Q	Q	Pump Spigot/SOP #5	OU2 GWTP Relocation
MW-BW-02-180		A	Q	PDB/SOP #2	OU2 ESD/OUCTP ROD
MW-BW-13-A		Q	Q	PDB/SOP #2	OU2 ROD
MW-BW-14-180		Q	Q	PDB/SOP #2	OU2 ESD

Well Name	Cu, Pb, Sb (6010D)	VOCs (8260-SIM)	Water Levels	Sampling Methods/SOP	Rationale ¹
MW-BW-50-A		Q	Q	PDB/SOP #2	OU2 ROD
MW-OU2-01-A	A	Q	Q	HydraSleeve™, PDB/ SOP #2, 3	OU2 ROD
MW-OU2-02-A	A	Q	Q	HydraSleeve™, PDB/ SOP #2, 3	OU2 ROD
MW-OU2-04-A		Q	Q	PDB/SOP #2	OU2 ROD
MW-OU2-05-AR		Q	Q	PDB/SOP #2	OU2 ESD
MW-OU2-06-180R2		Q	Q	PDB/SOP #2	OU2 ESD
MW-OU2-06-AR		Q	Q	PDB/SOP #2	OU2 ROD
MW-OU2-07-A		Q	Q	PDB/SOP #2	OU2 ROD
MW-OU2-08-A		Q	Q	PDB/SOP #2	OU2 ROD
MW-OU2-12-A		Q	Q	PDB/SOP #2	OU2 ROD
MW-OU2-20-180		Q	Q	PDB/SOP #2	OU2 ROD
MW-OU2-23-180		Q	Q	PDB/SOP #2	OU2 ESD
MW-OU2-24-180		Q	Q	PDB/SOP #2	OU2 ESD
MW-OU2-25-A		Q	Q	PDB/SOP #2	OU2 ROD
MW-OU2-27-A		Q	Q	PDB/SOP #2	OU2 ROD
MW-OU2-28-180		Q	Q	PDB/SOP #2	OU2 ESD
MW-OU2-28-A		Q	Q	PDB/SOP #2	OU2 ROD
MW-OU2-34-A		A	Q	PDB/SOP #2	OU2 ROD
MW-OU2-39-180		Q	Q	PDB/SOP #2	OU2 ESD
MW-OU2-40-A		Q	Q	PDB/SOP #2	OU2 ROD
MW-OU2-43-180		Q	Q	PDB/SOP #2	OU2 ESD
MW-OU2-44-A		Q	Q	PDB/SOP #2	OU2 ESD
MW-OU2-44-180		Q	Q	PDB/SOP #2	OU2 ESD
MW-OU2-45-A		Q	Q	PDB/SOP #2	OU2 ROD
MW-OU2-46-A		Q	Q	PDB/SOP #2	OU2 ROD
MW-OU2-46-180		Q	Q	PDB/SOP #2	OU2 ESD
MW-OU2-47-180		Q	Q	PDB/SOP #2	OU2 ESD
MW-OU2-50-180		Q	Q	PDB/SOP #2	OU2 ESD

Well Name	Cu, Pb, Sb (6010D)	VOCs (8260-SIM)	Water Levels	Sampling Methods/SOP	Rationale ¹
MW-OU2-51-180		Q	Q	PDB/SOP #2	OU2 ESD
MW-OU2-53-180		Q	Q	PDB/SOP #2	OU2 ESD
MW-OU2-56-180		Q	Q	PDB/SOP #2	OU2 ESD
MW-OU2-61-180		Q	Q	PDB/SOP #2	OU2 ESD
MW-OU2-62-180		Q	Q	PDB/SOP #2	OU2 ESD
MW-OU2-63-180		A	Q	PDB/SOP #2	OU2 ESD
MW-OU2-73-A	A	Q	Q	HydraSleeve™, PDB/ SOP #2, 3	OU2 ROD
MW-OU2-74-A	A	Q	Q	HydraSleeve™, PDB/ SOP #2, 3	OU2 ROD
MW-OU2-75-A		Q	Q	PDB/SOP #2	OU2 ROD
MW-OU2-76-A		Q	Q	PDB/SOP #2	OU2 ROD
MW-OU2-79-A		Q	Q	PDB/SOP #2	OU2 ESD
MW-OU2-80-A		Q	Q	PDB/SOP #2	OU2 ROD
MW-OU2-81-A		Q	Q	PDB/SOP #2	OU2 ROD
MW-OU2-81-180		Q	Q	PDB/SOP #2	OU2 ESD
MW-OU2-83-A		Q	Q	PDB/SOP #2	Well Install Completion Report (AEI, 2019)
MW-OU2-84-180		Q	Q	PDB/SOP #2	OU2 ESD
The Following Wells Are Measured for Groundwater Elevation Data Only:					
EW-OU2-01-A			Q	SOP #5	Groundwater elevation trend analysis
EW-OU2-03-A			Q	SOP #5	Groundwater elevation trend analysis
EW-OU2-04-180			Q	SOP #5	Groundwater elevation trend analysis
EW-OU2-07-A			Q	SOP #5	Groundwater elevation trend analysis
MW-14-03-180			Q	SOP #5	Groundwater elevation trend analysis
MW-BW-01-A			Q	SOP #5	Groundwater elevation trend analysis
MW-BW-11-A			Q	SOP #5	Groundwater elevation trend analysis
MW-BW-12-180			Q	SOP #5	Groundwater elevation trend analysis
MW-OU2-03-A			Q	SOP #5	Groundwater elevation trend analysis
MW-OU2-09-A			Q	SOP #5	Groundwater elevation trend analysis
MW-OU2-09-180R			Q	SOP #5	Groundwater elevation trend analysis

Well Name	Cu, Pb, Sb (6010D)	VOCs (8260-SIM)	Water Levels	Sampling Methods/SOP	Rationale ¹
MW-OU2-13-A			Q	SOP #5	Groundwater elevation trend analysis
MW-OU2-20-180X			Q	SOP #5	Groundwater elevation trend analysis
MW-OU2-21-A			Q	SOP #5	Groundwater elevation trend analysis
MW-OU2-23-A			Q	SOP #5	Groundwater elevation trend analysis
MW-OU2-29-180			Q	SOP #5	Groundwater elevation trend analysis
MW-OU2-29-A			Q	SOP #5	Groundwater elevation trend analysis
MW-OU2-30-A			Q	SOP #5	Groundwater elevation trend analysis
MW-OU2-31-180R			Q	SOP #5	Groundwater elevation trend analysis
MW-OU2-32-A			Q	SOP #5	Groundwater elevation trend analysis
MW-OU2-35-A			Q	SOP #5	Groundwater elevation trend analysis
MW-OU2-36-180			Q	SOP #5	Groundwater elevation trend analysis
MW-OU2-49-180			Q	SOP #5	Groundwater elevation trend analysis
MW-OU2-52-180			Q	SOP #5	Groundwater elevation trend analysis
MW-OU2-54-180			Q	SOP #5	Groundwater elevation trend analysis
MW-OU2-55-180			Q	SOP #5	Groundwater elevation trend analysis
MW-OU2-57-A			Q	SOP #5	Groundwater elevation trend analysis
MW-OU2-58-A			Q	SOP #5	Groundwater elevation trend analysis
MW-OU2-77-A			Q	SOP #5	Groundwater elevation trend analysis
PZ-OU2-06-180			Q	SOP #5	Groundwater elevation trend analysis

Notes:

A: sampled on an annual basis

Cu: copper

ESD: Explanation of Significant Differences

Pb: lead

PDB: passive diffusion bag

Q: sampled on a quarterly basis

ROD: Record of Decision

Sb: antimony

SIM: selected ion monitoring

SOP: standard operating procedures

VOCs: volatile organic compounds

¹The rationale for sampling locations and frequency is based on the applicable program RODs, ESDs, program history, and precedent established by the BCT, which includes the Army, USACE, EPA, DTSC, and CCRWQCB.

4.1.7 Worksheet #17c3: OUCTP A-Aquifer GWMP

Well Name	DO ORP	VOCs (8260-SIM)	Water Levels	Sampling Methods/SOP	Rationale ¹
EISB-EW-01		Q	Q	PDB/SOP #2	OUCTP ROD
EISB-EW-09		Q	Q	PDB/SOP #2	OUCTP ROD
EISB-EW-12	Q		Q	PTM/SOP #6/7	OUCTP ROD
EISB-EW-15	Q		Q	PTM/SOP #6/7	OUCTP ROD
EISB-MW-01		A	Q	PDB/SOP #2	OUCTP ROD
EW-BW-109-A		Q	Q	PDB/SOP #2	OUCTP ROD
EW-BW-124-A	Q	Q	Q	PTM/SOP #6/7; PDB/SOP #2	OUCTP ROD
EW-BW-129-A		Q	Q	PDB/SOP #2	OUCTP ROD
EW-BW-135-A	Q	Q	Q	PTM/SOP #6/7; PDB/SOP #2	OUCTP ROD
EW-BW-140-A		Q	Q	PDB/SOP #2	OUCTP ROD
EW-BW-144-A	Q	Q	Q	PTM/SOP #6/7	OUCTP ROD
EW-BW-149-A	Q	A	Q	PTM/SOP #6/7; PDB/SOP #2	OUCTP ROD
EW-BW-155-A	Q	Q	Q	PTM/SOP #6/7; PDB/SOP #2	OUCTP ROD
EW-BW-159-A	Q		Q	PTM/SOP #6/7	OUCTP ROD
EW-BW-160-A	Q	Q	Q	PTM/SOP #6/7; PDB/SOP #2	OUCTP ROD
EW-BW-161-A	Q		Q	PTM SOP #6/7	OUCTP ROD
EW-BW-164-A	Q		Q	PTM SOP #6/7	OUCTP ROD
EW-BW-165-A		A	Q	PDB/SOP #2	OUCTP ROD
EW-BW-166-A	Q	A	Q	PTM SOP #6/7; PDB/SOP #2	OUCTP ROD
EW-BW-167-A		A	Q	PDB/SOP #2	OUCTP ROD
EW-BW-169-A		A	Q	PDB/SOP #2	OUCTP ROD
MP-BW-46-095			Q	Westbay Port/SOP #1	OUCTP ROD
MW-40-01-A		Q	Q	PDB/SOP #2	OUCTP ROD
MW-B-12-A		Q	Q	PDB/SOP #2	OUCTP ROD
MW-B-14-A		Q	Q	PDB/SOP #2	OUCTP ROD
MW-BW-15-A		A	Q	PDB/SOP #2	OUCTP ROD
MW-BW-17-A		Q	Q	PDB/SOP #2	OUCTP ROD

Well Name	DO ORP	VOCs (8260- SIM)	Water Levels	Sampling Methods/SOP	Rationale ¹
MW-BW-24-A		A	Q	PDB/SOP #2	OUCTP ROD
MW-BW-26-A		Q	Q	PDB/SOP #2	OUCTP ROD
MW-BW-27-A		Q	Q	PDB/SOP #2	OUCTP ROD
MW-BW-28-A		Q	Q	PDB/SOP #2	OUCTP ROD
MW-BW-30-A		A	Q	PDB/SOP #2	OUCTP ROD
MW-BW-31-A		Q	Q	PDB/SOP #2	OUCTP ROD
MW-BW-32-A		Q	Q	PDB/SOP #2	OUCTP ROD
MW-BW-35-A		Q	Q	PDB/SOP #2	OUCTP ROD
MW-BW-36-A		Q	Q	PDB/SOP #2	OUCTP ROD
MW-BW-42-A		A	Q	PDB/SOP #2	OUCTP ROD
MW-BW-44-A		A	Q	PDB/SOP #2	OUCTP ROD
MW-BW-49-A		Q	Q	PDB/SOP #2	OUCTP ROD
MW-BW-56-A		Q	Q	PDB/SOP #2	OUCTP ROD
MW-BW-58-A		Q	Q	PDB/SOP #2	OUCTP ROD
MW-BW-60-A		A	Q	PDB/SOP #2	OUCTP ROD
MW-BW-65-A		Q	Q	PDB/SOP #2	OUCTP ROD
MW-BW-66-A		Q	Q	PDB/SOP #2	OUCTP ROD
MW-BW-71-A		Q	Q	PDB/SOP #2	OUCTP ROD
MW-BW-81-A		Q	Q	PDB/SOP #2	OUCTP ROD
MW-BW-74-A		A	Q	PDB/SOP #2	OUCTP ROD
MW-BW-75-A		Q	Q	PDB/SOP #2	OUCTP ROD
MW-BW-77-A		A	Q	PDB/SOP #2	OUCTP ROD
MW-BW-78-A		A	Q	PDB/SOP #2	OUCTP ROD
MW-BW-79-A		Q	Q	PDB/SOP #2	OUCTP ROD
MW-BW-80-A		Q	Q	PDB/SOP #2	OUCTP ROD
MW-BW-82-A		Q	Q	PDB/SOP #2	OUCTP ROD
MW-BW-83-A		A	Q	PDB/SOP #2	OUCTP ROD
MW-BW-85-A		Q	Q	PDB/SOP #2	OUCTP ROD

Well Name	DO ORP	VOCs (8260- SIM)	Water Levels	Sampling Methods/SOP	Rationale ¹
MW-BW-86-A		A	Q	PDB/SOP #2	OUCTP ROD
MW-BW-87-A		Q	Q	PDB/SOP #2	OUCTP ROD
MW-BW-88-A		Q	Q	PDB/SOP #2	OUCTP ROD
MW-BW-89-A		Q	Q	PDB/SOP #2	OUCTP ROD
MW-BW-90-A		Q	Q	PDB/SOP #2	OUCTP ROD
MW-BW-91-A		Q	Q	PDB/SOP #2	OUCTP ROD
MW-BW-92-A		Q	Q	PDB/SOP #2	OUCTP ROD
MW-BW-93-A		Q	Q	PDB/SOP #2	Well Install Completion Report (AEI, 2019)
MW-BW-94-AR		Q	Q	PDB/SOP #2	Well Install Completion Report (AEI, 2019)
MW-BW-95-A		Q	Q	PDB/SOP #2	Well Install Completion Report (AEI, 2019)
The Following Wells Are Measured for Groundwater Elevation Data Only:					
EISB-EW-02			Q	SOP #5	Groundwater elevation trend analysis
EISB-EW-03			Q	SOP #5	Groundwater elevation trend analysis
EISB-MW-04			Q	SOP #5	Groundwater elevation trend analysis
EW-BW-92-A			Q	SOP #5	Groundwater elevation trend analysis
EW-BW-93-A			Q	SOP #5	Groundwater elevation trend analysis
EW-BW-100-A			Q	SOP #5	Groundwater elevation trend analysis
EW-BW-104-A			Q	SOP #5	Groundwater elevation trend analysis
EW-BW-112-A			Q	SOP #5	Groundwater elevation trend analysis
EW-BW-119-A			Q	SOP #5	Groundwater elevation trend analysis
EW-BW-126-A			Q	SOP #5	Groundwater elevation trend analysis
EW-BW-132-A			Q	SOP #5	Groundwater elevation trend analysis
EW-BW-150-A			Q	SOP #5	Groundwater elevation trend analysis
EW-BW-168-A			Q	SOP #5	Groundwater elevation trend analysis
MP-BW-46-080			Q	Westbay Port /SOP #1	Groundwater elevation trend analysis
MP-BW-48-113			Q	Westbay Port /SOP #1	Groundwater elevation trend analysis
MP-BW-48-133			Q	Westbay Port /SOP #1	Groundwater elevation trend analysis
MW-BW-16-A			Q	SOP #5	Groundwater elevation trend analysis

Well Name	DO ORP	VOCs (8260- SIM)	Water Levels	Sampling Methods/SOP	Rationale ¹
MW-BW-18-A			Q	SOP #5	Groundwater elevation trend analysis
MW-BW-25-A			Q	SOP #5	Groundwater elevation trend analysis
MW-BW-34-A			Q	SOP #5	Groundwater elevation trend analysis
MW-BW-38-A			Q	SOP #5	Groundwater elevation trend analysis
MW-BW-39-A			Q	SOP #5	Groundwater elevation trend analysis
MW-BW-41-A			Q	SOP #5	Groundwater elevation trend analysis
MW-BW-43-A			Q	SOP #5	Groundwater elevation trend analysis
MW-BW-45-A			Q	SOP #5	Groundwater elevation trend analysis
MW-BW-46-A			Q	SOP #5	Groundwater elevation trend analysis
MW-BW-48-A			Q	SOP #5	Groundwater elevation trend analysis
MW-BW-51-A			Q	SOP #5	Groundwater elevation trend analysis
MW-BW-53-A			Q	SOP #5	Groundwater elevation trend analysis
MW-BW-54-A			Q	SOP #5	Groundwater elevation trend analysis
MW-BW-57-A			Q	SOP #5	OUCTP ROD
MW-BW-59-A			Q	SOP #5	Groundwater elevation trend analysis
MW-BW-63-A			Q	SOP #5	Groundwater elevation trend analysis
MW-BW-67-A			Q	SOP #5	Groundwater elevation trend analysis

Notes:

A: sampled on an annual basis

DO: dissolved oxygen

ORP: oxidation-reduction potential

PDB: passive diffusion bag

PTM: post-treatment monitoring

Q: sampled on a quarterly basis

ROD: Record of Decision

SIM: selected ion monitoring

SOP: standard operating procedures

¹ The rationale for sampling locations and frequency is based on the applicable program RODs, ESDs, program history and precedent established by the BCT, which includes the Army, USACE, EPA, DTSC, and CCRWQCB.

4.1.8 Worksheet #17c4: OUCTP Upper 180-Foot Aquifer GWMP

Well Name	VOCs (8260-SIM)	Water Levels	Sampling Methods/SOP	Rationale ¹
EW-OU2-09-180	Q	Q	Pump Spigot/SOP #5	OUCTP ROD
MP-BW-33-272	Q	Q	Westbay Port /SOP #1	OUCTP ROD
MP-BW-46-170	Q	Q	Westbay Port/SOP #1	OUCTP ROD
MW-BW-21-180	Q	Q	PDB/SOP #2	OUCTP ROD
MW-BW-43-180	Q	Q	PDB/SOP #2	OUCTP ROD
MW-BW-52-180	Q	Q	PDB/SOP #2	OUCTP ROD
MW-BW-57-180	Q	Q	PDB/SOP #2	Well Install Completion Report (AEI, 2019)
MW-BW-58-180	A	Q	PDB/SOP #2	Well Install Completion Report (AEI, 2019)
MW-OU2-30-180	A	Q	PDB/SOP #2	OU2 ESD
MW-OU2-64-180	Q	Q	PDB/SOP #2	OUCTP ROD
MW-OU2-67-180	Q	Q	PDB/SOP #2	OUCTP ROD
MW-OU2-70-180	A	Q	PDB/SOP #2	OUCTP ROD
The Following Wells Are Measured for Groundwater Elevation Data Only:				
MP-BW-30-282		Q	Westbay Port /SOP #1	Groundwater elevation trend analysis
MP-BW-32-287		Q	Westbay Port /SOP #1	Groundwater elevation trend analysis
MP-BW-35-242		Q	Westbay Port /SOP #1	Groundwater elevation trend analysis
MP-BW-37-178		Q	Westbay Port /SOP #1	Groundwater elevation trend analysis
MP-BW-37-193		Q	Westbay Port /SOP #1	Groundwater elevation trend analysis
MP-BW-41-202		Q	Westbay Port /SOP #1	Groundwater elevation trend analysis
MP-BW-41-231		Q	Westbay Port /SOP #1	Groundwater elevation trend analysis
MP-BW-41-256		Q	Westbay Port /SOP #1	Groundwater elevation trend analysis
MP-BW-42-195		Q	Westbay Port /SOP #1	Groundwater elevation trend analysis
MP-BW-42-215		Q	Westbay Port /SOP #1	Groundwater elevation trend analysis
MP-BW-42-235		Q	Westbay Port/SOP #1	Groundwater elevation trend analysis
MP-BW-46-185		Q	Westbay Port /SOP #1	Groundwater elevation trend analysis
MP-BW-46-200		Q	Westbay Port /SOP #1	Groundwater elevation trend analysis
MP-BW-46-215		Q	Westbay Port /SOP #1	Groundwater elevation trend analysis
MW-B-05-180		Q	SOP #5	Groundwater elevation trend analysis

Well Name	VOCs (8260-SIM)	Water Levels	Sampling Methods/SOP	Rationale ¹
MW-BW-26-180		Q	SOP #5	Groundwater elevation trend analysis
MW-BW-44-180		Q	SOP #5	Groundwater elevation trend analysis
MW-BW-45-180		Q	SOP #5	Groundwater elevation trend analysis
MW-BW-47-180		Q	SOP #5	Groundwater elevation trend analysis
MW-BW-49-180		Q	SOP #5	Groundwater elevation trend analysis
MW-BW-50-180		Q	SOP #5	Groundwater elevation trend analysis
MW-BW-51-180		Q	SOP #5	Groundwater elevation trend analysis
MW-BW-53-180		Q	SOP #5	Groundwater elevation trend analysis
MW-BW-54-180		Q	SOP #5	Groundwater elevation trend analysis
MW-BW-55-180		Q	SOP #5	Groundwater elevation trend analysis
MW-BW-56-180		Q	SOP #5	Groundwater elevation trend analysis

Notes:

A: sampled on an annual basis

PDB: passive diffusion bag

PTM: post-treatment monitoring

Q: sampled on a quarterly basis

ROD: Record of Decision

SIM: selected ion monitoring

SOP: standard operating procedures

¹The rationale for sampling locations and frequency is based on the applicable program RODs, ESDs, program history, and precedent established by the BCT, which includes the Army, USACE, EPA, DTSC, and CCRWQCB.

4.1.9 Worksheet #17c5: OUCTP Lower 180-Foot Aquifer GWMP

Well Name	VOCs (8260-SIM)	Water Levels	Sampling Methods/SOP	Rationale ¹
Airfield	A	Q	PDB/SOP #2	OUCTP ROD
EW-OU2-07-180	Q	Q	PDB/SOP #2	OUCTP ROD
FO-29 ²	Q		Sampling Port/SOP #4	OUCTP ROD
FO-30 ²	Q		Sampling Port/SOP #4	OUCTP ROD
FO-31 ²	Q		Sampling Port/SOP #4	OUCTP ROD
MP-BW-41-318	Q	Q	Westbay Port/SOP #1	OUCTP ROD
MP-BW-41-353	Q	Q	Westbay Port/SOP #1	OUCTP ROD
MP-BW-42-345	Q	Q	Westbay Port/SOP #1	OUCTP ROD
MP-BW-49-287	Q	Q	Westbay Port/SOP #1	OUCTP ROD
MP-BW-49-316	Q	Q	Westbay Port/SOP #1	OUCTP ROD
MP-BW-49-368	Q	Q	Westbay Port/SOP #1	OUCTP ROD
MP-BW-49-400	Q	Q	Westbay Port /SOP #1	OUCTP ROD
MP-BW-50-339	Q	Q	Westbay Port /SOP #1	OUCTP ROD
MP-BW-50-384	Q	Q	Westbay Port /SOP #1	OUCTP ROD
MP-BW-51-405	Q	Q	Westbay Port /SOP #1	OUCTP ROD
MW-BW-04-180	A	Q	PDB/SOP #2	OUCTP ROD
MW-BW-59-180	Q	Q	PDB/SOP #2	Well Install Completion Report (AEI, 2019)
MW-OU2-66-180	Q	Q	PDB/SOP #2	OU2 ESD
MW-OU2-69-180	Q	Q	PDB/SOP #2	OU2 ESD
MW-OU2-72-180	Q	Q	PDB/SOP #2	OU2 ESD
MW-OU2-78-180	Q	Q	PDB/SOP #2	OU2 ESD
MW-OU2-82-180	Q	Q	PDB/SOP #2	OU2 ESD
The Following Wells Are Measured for Groundwater Elevation Data Only:				
MCWD-08A ²		Q	MCWD	Groundwater elevation trend analysis
MP-BW-30-317		Q	Westbay Port /SOP #1	Groundwater elevation trend analysis
MP-BW-30-342		Q	Westbay Port /SOP #1	Groundwater elevation trend analysis
MP-BW-30-397		Q	Westbay Port /SOP #1	Groundwater elevation trend analysis

Well Name	VOCs (8260-SIM)	Water Levels	Sampling Methods/SOP	Rationale ¹
MP-BW-30-467		Q	Westbay Port /SOP #1	Groundwater elevation trend analysis
MP-BW-30-537		Q	Westbay Port /SOP #1	Groundwater elevation trend analysis
MP-BW-31-292		Q	Westbay Port/SOP #1	Groundwater elevation trend analysis
MP-BW-31-332		Q	Westbay Port/SOP #1	Groundwater elevation trend analysis
MP-BW-31-362		Q	Westbay Port /SOP #1	Groundwater elevation trend analysis
MP-BW-31-407		Q	Westbay Port /SOP #1	Groundwater elevation trend analysis
MP-BW-31-457		Q	Westbay Port /SOP #1	Groundwater elevation trend analysis
MP-BW-31-522		Q	Westbay Port /SOP #1	Groundwater elevation trend analysis
MP-BW-32-332		Q	Westbay Port /SOP #1	Groundwater elevation trend analysis
MP-BW-32-366		Q	Westbay Port /SOP #1	Groundwater elevation trend analysis
MP-BW-32-412		Q	Westbay Port /SOP #1	Groundwater elevation trend analysis
MP-BW-32-472		Q	Westbay Port /SOP #1	Groundwater elevation trend analysis
MP-BW-32-522		Q	Westbay Port /SOP #1	Groundwater elevation trend analysis
MP-BW-33-317		Q	Westbay Port /SOP #1	Groundwater elevation trend analysis
MP-BW-33-352		Q	Westbay Port /SOP #1	Groundwater elevation trend analysis
MP-BW-33-397		Q	Westbay Port /SOP #1	Groundwater elevation trend analysis
MP-BW-34-292		Q	Westbay Port /SOP #1	Groundwater elevation trend analysis
MP-BW-34-357		Q	Westbay Port /SOP #1	Groundwater elevation trend analysis
MP-BW-34-422		Q	Westbay Port /SOP #1	Groundwater elevation trend analysis
MP-BW-34-492		Q	Westbay Port /SOP #1	Groundwater elevation trend analysis
MP-BW-34-537		Q	Westbay Port /SOP #1	Groundwater elevation trend analysis
MP-BW-35-312		Q	Westbay Port /SOP #1	Groundwater elevation trend analysis
MP-BW-35-366		Q	Westbay Port /SOP #1	Groundwater elevation trend analysis
MP-BW-35-402		Q	Westbay Port /SOP #1	Groundwater elevation trend analysis
MP-BW-35-467		Q	Westbay Port /SOP #1	Groundwater elevation trend analysis
MP-BW-35-527		Q	Westbay Port /SOP #1	Groundwater elevation trend analysis
MP-BW-35-562		Q	Westbay Port /SOP #1	Groundwater elevation trend analysis
MP-BW-37-303		Q	Westbay Port/SOP #1	Groundwater elevation trend analysis

Well Name	VOCs (8260-SIM)	Water Levels	Sampling Methods/SOP	Rationale ¹
MP-BW-37-328		Q	Westbay Port /SOP #1	Groundwater elevation trend analysis
MP-BW-37-368		Q	Westbay Port /SOP #1	Groundwater elevation trend analysis
MP-BW-37-398		Q	Westbay Port /SOP #1	Groundwater elevation trend analysis
MP-BW-37-460		Q	Westbay Port /SOP #1	Groundwater elevation trend analysis
MP-BW-38-327		Q	Westbay Port /SOP #1	Groundwater elevation trend analysis
MP-BW-38-341		Q	Westbay Port /SOP #1	Groundwater elevation trend analysis
MP-BW-38-353		Q	Westbay Port /SOP #1	Groundwater elevation trend analysis
MP-BW-38-368		Q	Westbay Port /SOP #1	Groundwater elevation trend analysis
MP-BW-38-418		Q	Westbay Port /SOP #1	Groundwater elevation trend analysis
MP-BW-39-310		Q	Westbay Port /SOP #1	Groundwater elevation trend analysis
MP-BW-39-330		Q	Westbay Port /SOP #1	Groundwater elevation trend analysis
MP-BW-39-350		Q	Westbay Port /SOP #1	Groundwater elevation trend analysis
MP-BW-39-395		Q	Westbay Port /SOP #1	Groundwater elevation trend analysis
MP-BW-40-333		Q	Westbay Port /SOP #1	Groundwater elevation trend analysis
MP-BW-40-353		Q	Westbay Port /SOP #1	Groundwater elevation trend analysis
MP-BW-40-375		Q	Westbay Port /SOP #1	Groundwater elevation trend analysis
MP-BW-40-400		Q	Westbay Port /SOP #1	Groundwater elevation trend analysis
MP-BW-41-286		Q	Westbay Port /SOP #1	Groundwater elevation trend analysis
MP-BW-41-396		Q	Westbay Port /SOP #1	Groundwater elevation trend analysis
MP-BW-42-295		Q	Westbay Port /SOP #1	Groundwater elevation trend analysis
MP-BW-42-314		Q	Westbay Port /SOP #1	Groundwater elevation trend analysis
MP-BW-42-400		Q	Westbay Port /SOP #1	Groundwater elevation trend analysis
MP-BW-49-336		Q	Westbay Port /SOP #1	Groundwater elevation trend analysis
MP-BW-50-289		Q	Westbay Port /SOP #1	Groundwater elevation trend analysis
MP-BW-50-309		Q	Westbay Port /SOP #1	Groundwater elevation trend analysis
MP-BW-50-359		Q	Westbay Port /SOP #1	Groundwater elevation trend analysis
MP-BW-51-315		Q	Westbay Port /SOP #1	Groundwater elevation trend analysis
MP-BW-51-340		Q	Westbay Port /SOP #1	Groundwater elevation trend analysis

Well Name	VOCs (8260-SIM)	Water Levels	Sampling Methods/SOP	Rationale ¹
MP-BW-51-370		Q	Westbay Port /SOP #1	Groundwater elevation trend analysis
MP-BW-52-323		Q	Westbay Port /SOP #1	Groundwater elevation trend analysis
MP-BW-52-338		Q	Westbay Port /SOP #1	Groundwater elevation trend analysis
MP-BW-52-363		Q	Westbay Port /SOP #1	Groundwater elevation trend analysis
MP-BW-52-388		Q	Westbay Port /SOP #1	Groundwater elevation trend analysis
MP-BW-52-408		Q	Westbay Port /SOP #1	Groundwater elevation trend analysis
MW-BW-03-400		Q	SOP #7	Groundwater elevation trend analysis
MW-OU2-07-400		Q	SOP #7	Groundwater elevation trend analysis
MW-OU2-28-400		Q	SOP #7	Groundwater elevation trend analysis
MW-OU2-71-180		Q	SOP #7	Groundwater elevation trend analysis
Test 2		Q	SOP #7	Groundwater elevation trend analysis

Notes:

A: sampled on an annual basis

MCWD: Marina Coast Water District collects data

PDB: passive diffusion bag

PTM: post-treatment monitoring

Q: sampled on a quarterly basis

ROD: Record of Decision

SIM: selected ion monitoring

SOP: standard operating procedures

¹The rationale for sampling locations and frequency is based on the applicable program RODs, ESDs, program history and precedent established by the BCT, which includes the Army, USACE, EPA, DTSC, and CCRWQCB.

²Well owned by MCWD.

4.2 Worksheet #18: Sampling Locations and Methods

This Worksheet was not used. Information that would be included in this Worksheet is incorporated into Worksheets #17a through #17c.

5.0 Sampling Requirements

5.1 Worksheets #19 and #30: Sample Container, Preservation, and Hold Times

Laboratory: SGS

Florida:

4405 Vineland Rd, Suite C-15

Orlando, FL 32811

Telephone: (407) 425-6700

Point of Contact: Svetlana Izosimova

E-mail: Svetlana.Izosimova@sgs.com

Sample Delivery Method: Courier to San Jose, CA distribution center or FedEx overnight shipment to Florida

Matrix	Analytical Group	Preparation/Analytical Method	Sample Volume	Containers	Preservation	Holding Time ¹	SGS Laboratory
Water	VOCs	EPA 5030/8260-SIM	120 mL	Three 40-mL Teflon-lined® VOA Vials	HCl to pH < 2 Sample temp > 0°C ≤ 6°C	14 days	Florida
	Dissolved Metals	EPA 3010A/6010D	500 mL	One 250-mL HDPE bottles	HNO ₃ to pH < 2 after field filtering Sample temp > 0°C ≤ 6°C	6 months	
	Chloride	EPA 9056A	100 mL	One 250-mL HDPE bottle	Sample temp > 0°C ≤ 6°C	28 days	

Notes:

°C: degrees Celsius

HCl: hydrochloric acid

HDPE: high-density polyethylene

HNO₃: nitric acid

mL: milliliter

VOA: volatile organic analysis

VOCs: volatile organic compounds

¹ Data package TAT is 15 business days

5.2 Worksheet #20: Field Quality Control Summary

Matrix	Analytical Group (Method)	Frequency of Field Duplicate Samples	Frequency of Trip Blanks	Frequency of Field Blanks	Frequency of Equip Blanks	Frequency of MS/MSD
Water	VOCs (8260-SIM)	10% of field samples collected	1 set per cooler /day	1 per sampling day	1 per sampling event (Westbay sampling only ¹)	5% of field samples collected
	Metals (6010D)	10% of field samples collected	N/A	N/A	N/A	5% of field samples collected
	Cl (9056A)	10% of field samples collected	N/A	N/A	N/A	5% of field samples collected

Notes:

Cl: chloride

MS/MSD: matrix spike/matrix spike duplicate

N/A: not applicable

VOCs: volatile organic compounds

¹Sampling at Westbay wells requires reuse and decontamination of sampling equipment. Sampling with PDBs, HydraSleeves, and from sampling ports is performed with non-reusable sampling equipment, and no decontamination of field equipment is required. Westbay sample locations are identified as “Westbay Port” in the “Sampling Method” column of Worksheet #17c.

5.3 Worksheet #21: Field SOPs/Methods

SOP Reference Number	Title	Organization	Revision Date	Equipment Type	Modified for Project Work?	Comments
SOP #1	Westbay MOSDAX Sampler Probe – Model 2531 Operations Manual	Schlumberger	Oct. 20, 2006	Westbay Multi-port Wells	No	
SOP #2	PDB Sampling Protocol	U.S. Geological Survey (USGS)	2001	PDBs	Yes	Project-specific procedures are appended to USGS User's Guide
SOP #3	HydraSleeve Field Manual	GeoInsight	2006	HydraSleeve	No	
SOP #4	Supply and Irrigation Well Sampling Protocol	Ahtna	2016	Sampling Ports	Yes	GWMP project-specific procedures
SOP #5	OU2 and Sites 2/12 GWTs and OUCTP EISB Extraction Well Sample Handling and Custody Requirements	Ahtna	2016	Sampling Ports	Yes	GWTS project-specific procedures
SOP #6	Low Flow Groundwater Quality Parameter Collection	Ahtna	2016	Horiba Multi-Meter and Low Flow Pump	Yes	OUCTP GWMP project-specific procedures
SOP #7	Downhole Meter Groundwater Quality Parameter Collection	Ahtna	2016	YSI Sonde Downhole Meter	Yes	OUCTP GWMP project-specific procedures

Note: SOPs are provided in Attachment A.

5.4 Worksheet #22: Field Equipment Calibration, Maintenance, Testing, and Inspection

Field Equipment	Calibration Activity	Maintenance Activity	Testing Activity	Inspection Activity	Frequency	Acceptance Criteria	Corrective Action	Responsible Person	SOP Reference
Electric Water Level Sounder	Calibrated against steel tape	Maintain in proper working order, store in a secure location, decon after each use	Check battery and sensitivity daily prior to use	Inspect tape for damage prior to use	Quarterly prior to use	Calibrates with steel tape to within 0.05 ft/100 feet depth to water	Send into factory for repair	Field Supervisor	SOPs #2 & #5
YSI Sonde Downhole Meter	Calibrated with solutions	Decon after each use, store according to manufacturer directions	Check battery prior to use	Inspect for damage prior to use	Quarterly prior to use	According to manufacturer instructions	Check manual or send to factory for repair	Field Supervisor	SOP #7
Digital Thermometer	Factory calibrated, ice-point method per HACCP-based SOP	Store in a secure location, avoid excessive heat	Check battery prior to use	Inspect for damage prior to use	Annually	Factory calibration, temperature reading = $0^{\circ}\text{C} \pm 1^{\circ}\text{C}$	Replace with new unit	Field Supervisor	SOPs #2 & #5

Notes:

°C: degrees Celsius

HACCP: Hazard Analysis & Critical Control Points (Title 9 Code of Federal Regulations Part 417)

N/A: not applicable

SOP: standard operating procedures

6.0 Analytical Requirements

6.1 Worksheet #23: Analytical SOPs

The SOPs referenced below are the laboratory-specific procedures for the tests for which the laboratory is certified under the DoD Environmental Laboratory Accreditation Program (ELAP). Laboratories with the DoD ELAP certificate undergo annual audits by the independent accrediting bodies responsible for the DoD ELAP certification. Copies of certifications, including the specifically referenced methods, are included in Attachment E.

Data will be evaluated based on the guidance provided in the DoD QSM Version 5.3, the published methods, and the laboratory QA Manual.

SOP Reference Number	Title	Organization	Revision Date	Equipment Type	Modified for Project Work?
SGS SOP# MS010.9	Analysis of Volatile Organics by GC/MS Select Ion Monitoring (SIM) (VOCs by 8260 SIM)	SGS	Dec 21, 2020	Analytical Instruments	No
SGS SOP# MET108.05	Metals by Inductively Coupled Plasma Atomic Emission Spectrometry (ICP) (Metals by 6010D)	SGS	Dec 20, 2020	Analytical Instruments	No
SGS SOP# GN228.10	Determination of Inorganic Anions by Ion Chromatography (Chloride by 9056A)	SGS	Dec 21, 2020	Analytical Instruments	No
SGS SOP# ORLD-SAM-101-21-SOPT	Sample Receipt and Storage	SGS	Mar 12, 2020	None	No
SGS SOP# SAM108.11	Sample and Laboratory Waste Disposal	SGS	Aug 24, 2020	None	No

6.2 Worksheet #24: Analytical Instrument Calibration

Instrument/ Analysis	Calibration Requirements	Frequency of Calibration	Acceptance Criteria	Corrective Action	Responsible Person
GC/MS – VOCs by EPA Method 8260-SIM	Check of instrument tuning using BFB	Prior to ICAL and every 12 hours	Refer to method for specific ion criteria	Re-tune instrument Re-analyze affected	GC/MS Analyst
	Multipoint calibration (minimum of five points), lowest point at or below LOQ	Initially and as required	Minimum RF per method. Each analyte must meet one of the three options below: Option 1: RSD for each analyte $\leq 15\%$ Option 2: linear least squares regression $r^2 \geq 0.99$ Option 3: non-linear regression – coefficient of determination (COD) $r^2 \geq 0.99$ (six points shall be used for second order, seven for third order)	Correct problem, then repeat ICAL.	GC/MS Analyst
	Second Source – ICV Standard	Once after each ICAL	Analytes within $\pm 20\%$ of true value	Correct problem and verify second source standard. Re-run second source verification. If that fails, correct the problem and repeat ICAL.	GC/MS Analyst
Instrument blanks and method blanks	After initial calibration and daily, prior to sample analysis (instrument blank) and with each	No analytes detected $> \frac{1}{2}$ LOQ or $> \frac{1}{10}$ the amount measured in any sample or $\frac{1}{10}$ the regulatory limit, whichever is greater.	Re-analyze blank Clean system Re-analyze affected samples	GC/MS Analyst	

Instrument/ Analysis	Calibration Requirements	Frequency of Calibration	Acceptance Criteria	Corrective Action	Responsible Person
		batch of samples (method blank)	Common contaminants must not be detected > LOQ		
GC/MS – VOCs by EPA Method 8260-SIM (continued)	Continuing calibration verification (CCV) standard	Daily before sample analysis and every 12 hours of analysis time, and at the end of the analytical run	RF criteria per method. All reported analytes and surrogates within $\pm 20\%$ of true value All reported analytes and surrogates within $\pm 50\%$ for end of analytical batch CCV	Correct problem, then re- run the CCV. If that fails, repeat ICAL. Re-analyze samples run since last successful CCV.	GC/MS Analyst
ICP Metals by EPA Method 6010D	ICAL: Single or multipoint calibration. Minimum one high standard and a calibration blank	Daily ICAL prior to sample analysis	If more than one calibration standard is used, $r^2 \geq 0.99$	Correct problem, then repeat ICAL.	ICP Analyst
	Second Source (ICV) Standard	Once after each ICAL, prior to sample analysis	Value of second standard source for target analytes within $\pm 10\%$ of true value	Correct the problem and verify second source standard. Re-run ICV. If that fails, correct problem and repeat ICAL.	ICP Analyst
	CCV	After analysis of every 10 samples and at the end of the analytical sequence	Within $\pm 10\%$ of true value	Correct problem, then re- run the CCV. If that fails, repeat ICAL. Re-analyze samples run since last successful CCV.	ICP Analyst
	Low-level calibration check standard (LOQ low point standard from calibration)	Daily, following one point ICAL	Within $\pm 20\%$ of true value	Correct problem, then re- analyze.	ICP Analyst

Instrument/ Analysis	Calibration Requirements	Frequency of Calibration	Acceptance Criteria	Corrective Action	Responsible Person
	ICS (Interference check sample)	After ICAL and prior to sample analysis	ICS-A: Absolute value of concentration for all non-spiked project analytes < ½ LOQ (unless they are a verified trace impurity from one of the spiked analytes)	Terminate analysis. Locate and correct problem. Re-analyze ICS and samples.	ICP Analyst
ICP Metals by EPA Method 6010D (continued)	Calibration blanks	Immediately after the ICV and Immediately after every CCV	The absolute values of all analytes must be < ½ LOQ or < 1/10 the amount measured in any sample	Calibration blanks: Correct the problem. Re-prepare and re-analyze calibration blank. Samples following the last acceptable calibration blank must be re-analyzed.	ICP Analyst
Ion Chromatography – Chloride by EPA Method 9056A	Initial Calibration (minimum three standards and one calibration blank)	ICAL prior to sample analysis	$r^2 \geq 0.99$	Correct problem, then repeat ICAL.	IC Analyst
	ICV	After each ICAL and prior to sample analysis	Analytes within ± 10% of true values and retention times within appropriate windows	Correct problem and verify second source standard. Re-run ICV. If that fails, correct the problem and repeat ICAL.	IC Analyst
	Retention time window position establishment	Once per multipoint calibration	Retention time width is set using the midpoint standard of the ICAL for each analyte when ICAL is performed. On days when ICAL is not performed, the initial CCV is used	If the retention time shifts by more than 10%, a new ICAL is performed.	IC Analyst

Instrument/ Analysis	Calibration Requirements	Frequency of Calibration	Acceptance Criteria	Corrective Action	Responsible Person
Ion Chromatography – Chloride by EPA Method 9056A (continued)	CCV	After ICAL, after every ten samples, and at end of run	Analytes within established retention time windows and within $\pm 10\%$ of true value	Correct problem, then re- run the CCV. If that fails, repeat ICAL. Re-analyze samples run since last successful CCV.	Wet Chemistry Analyst

Notes:

%D: percent difference / percent drift

BFB: 4-bromofluorobenzene

CCC: continuing calibration check compounds

CCV: continuing calibration verification

COD: coefficient of determination

GC/MS: gas chromatography / mass spectrometry

ICAL: initial calibration

ICP: inductively coupled plasma atomic emission spectroscopy

ICS: interference check sample

ICS-A: interference check standard A

ICS-AB: interference check standard AB

ICV: initial calibration verification

LOD: limit of detection

LOQ: limit of quantitation

N/A: not applicable

RF: response factor

RSD: relative standard deviation

SIM: selected ion monitoring

VOCs: volatile organic compounds

¹ Normal balance and thermometer calibration applies (Worksheet #25).

6.3 Worksheet #25: Analytical Instrument and Equipment Maintenance, Testing and Inspection

Analytical instruments used for this project will be maintained in accordance with the requirements presented in the SGS QA Manual and the individual analytical method SOPs. The SGS QA Manual also presents the documentation requirements for maintenance activities.

Instrument/Equipment	Maintenance/Inspection Activity	Frequency	Person Responsible for Corrective Action
GC/MS	Inspect/replace column Clean ion source Inspect, clean concentrator trap Change electron multiplier Backflush purge and trap Change rough oil pump	As required. Refer to Analytical Method and instrument manufacturer.	GC/MS Analyst
ICP	Inspect/replace tubing and pump Inspect/replace windings Inspect/replace torch and injector	As required. Refer to Analytical Method and instrument manufacturer.	ICP Analyst
IC	Inspect/perform column cleanup	As required. Refer to Analytical Method and instrument manufacturer.	IC Analyst

Notes:

GC/MS: gas chromatography/mass spectrometry

IC: ion chromatography

ICP: inductively coupled plasma

6.4 Worksheets #26 and #27: Sample Handling, Custody, and Disposal

Groundwater samples will be collected in laboratory-provided bottles using methods described in Worksheets #17a through #17c and #19, and SOPs #1 through #5. Samples will be received and logged into the laboratory information management system for analysis as described in the DoD QSM Version 5.3. Chain of custody procedures will be performed in accordance with Worksheet #29.

Sample organization: Ahtna

Laboratory: SGS

Method of sample delivery (shipper/carrier): SGS courier or FedEx overnight shipping

Number of days from reporting until sample disposal: No less than 30 days after final report sent to the client

Activity	Organization and Title or Position of Person Responsible for the Activity	SOP Reference
Sample Labeling	Ahtna/ Blaine Tech Field Technicians	SOP #5
Chain of custody form completion	Ahtna/ Blaine Tech Field Technicians	SOP #5
Packaging	Ahtna/ Blaine Tech Field Technicians	SOP #5
Shipping coordination	Ahtna/ Blaine Tech Field Technicians	SOP #5
Sample receipt, inspection, & log-in	SGS Sample Management Supervisor	SOP #SAM101.21
Sample custody and storage	SGS Sample Management Supervisor	SOP #SAM101.21
Sample disposal	SGS Sample Management Supervisor	SOP #SAM108.10

Notes:

N/A: not applicable

O&M: operations and maintenance

6.5 Worksheet #28: Analytical Quality Control and Corrective Action

6.5.1 Worksheet #28a: VOCs

Matrix: Groundwater (µg/L)

Analytical Group/Test Method: VOCs by EPA Method 8260-SIM

QC Sample	Frequency	Acceptance Limits	Source of Acceptance Limits	Corrective Action	Responsible Person	Data Quality Indicator																																													
Method Blank	1 per analytical batch	No analytes detected > ½ LOQ or > ¼ ₁₀ the amount measured in any sample or ¼ ₁₀ the regulatory limit, whichever is greater. Common contaminants must not be detected > LOQ.	DoD QSM 5.3 App B Table B-4	Re-analyze method blank. If it fails, clean the system and re-analyze blank and affected samples.	GC/MS Analyst	Accuracy/ Bias Contamination																																													
Laboratory Control Sample (LCS)/ LCSD	1 set per analytical batch. Spike target compounds. VC to be spiked at DL of 0.1 µg/L.	<table border="1"> <thead> <tr> <th>Analyte</th> <th>Recovery</th> <th>RPD</th> </tr> </thead> <tbody> <tr> <td>1,1-DCA</td> <td>77-125%</td> <td>≤ 20%</td> </tr> <tr> <td>1,1-DCE</td> <td>71-131%</td> <td>≤ 20%</td> </tr> <tr> <td>1,2-DCA</td> <td>73-128%</td> <td>≤ 20%</td> </tr> <tr> <td>1,2-DCE (total)</td> <td>79-121%</td> <td>≤ 20%</td> </tr> <tr> <td>1,2-DCPA</td> <td>78-122%</td> <td>≤ 20%</td> </tr> <tr> <td>1,3-DCPE (total)</td> <td>77-123%</td> <td>≤ 20%</td> </tr> <tr> <td>Benzene</td> <td>79-120%</td> <td>≤ 20%</td> </tr> <tr> <td>CT</td> <td>72-136%</td> <td>≤ 20%</td> </tr> <tr> <td>Chloroform</td> <td>79-124%</td> <td>≤ 20%</td> </tr> <tr> <td>cis-1,2-DCE</td> <td>78-123%</td> <td>≤ 20%</td> </tr> <tr> <td>MC</td> <td>74-124%</td> <td>≤ 20%</td> </tr> <tr> <td>PCE</td> <td>74-129%</td> <td>≤ 20%</td> </tr> <tr> <td>TCE</td> <td>79-123%</td> <td>≤ 20%</td> </tr> <tr> <td>VC</td> <td>58-137%</td> <td>≤ 20%</td> </tr> </tbody> </table>	Analyte	Recovery	RPD	1,1-DCA	77-125%	≤ 20%	1,1-DCE	71-131%	≤ 20%	1,2-DCA	73-128%	≤ 20%	1,2-DCE (total)	79-121%	≤ 20%	1,2-DCPA	78-122%	≤ 20%	1,3-DCPE (total)	77-123%	≤ 20%	Benzene	79-120%	≤ 20%	CT	72-136%	≤ 20%	Chloroform	79-124%	≤ 20%	cis-1,2-DCE	78-123%	≤ 20%	MC	74-124%	≤ 20%	PCE	74-129%	≤ 20%	TCE	79-123%	≤ 20%	VC	58-137%	≤ 20%	DoD QSM 5.3 App C Table C-24	Re-prep and re-analyze LCS/LCSD and associated batch samples	GC/MS Analyst	Bias Accuracy/ Precision
Analyte	Recovery	RPD																																																	
1,1-DCA	77-125%	≤ 20%																																																	
1,1-DCE	71-131%	≤ 20%																																																	
1,2-DCA	73-128%	≤ 20%																																																	
1,2-DCE (total)	79-121%	≤ 20%																																																	
1,2-DCPA	78-122%	≤ 20%																																																	
1,3-DCPE (total)	77-123%	≤ 20%																																																	
Benzene	79-120%	≤ 20%																																																	
CT	72-136%	≤ 20%																																																	
Chloroform	79-124%	≤ 20%																																																	
cis-1,2-DCE	78-123%	≤ 20%																																																	
MC	74-124%	≤ 20%																																																	
PCE	74-129%	≤ 20%																																																	
TCE	79-123%	≤ 20%																																																	
VC	58-137%	≤ 20%																																																	

QC Sample	Frequency	Acceptance Limits	Source of Acceptance Limits	Corrective Action	Responsible Person	Data Quality Indicator
MS/MSD	1 per analytical batch spike target compounds. VC to be spiked at DL of 0.1 µg/L.	Same as LS/LCSD acceptance limits for 8260-SIM.	Lab-derived	<p>If MS results are outside LCS limits, the data shall be evaluated to determine the source of difference and to determine if there is a matrix effect or analytical error.</p> <p>If the concentration in parent sample is > 4x the spiked amount, include in case narrative. No corrective action required.</p>	GC/MS Analyst	Bias/Precision
Surrogates	Field samples and laboratory QC	1,2-Dichloroethane-d4 81-118% Toluene-d8 89-112%	Lab-derived	Re-prep and re-analyze affected samples unless matrix interference is present.	GC/MS Analyst	Bias
Internal Standards	Field samples, standards, and laboratory QC	Retention time ±10 seconds from retention time of the midpoint standard in the ICAL; extracted ion current profile area within -50% to +100% of ICAL midpoint standard. On days when ICAL is not performed, the daily initial CCV can be used.	DoD QSM 5.3 App B Table B-4	Inspect mass spectrometer and GC for malfunction. Re-analysis of samples analyzed while system was malfunctioning is mandatory.	GC/MS Analyst	Bias/Precision

Notes on next page.

Notes:

#: percent

µg/L: micrograms per liter

CCV: continuing calibration verification

cis-1,2-DCE: cis-1,2-dichloroethene

CT: carbon tetrachloride

1,1-DCA: 1,1-dichloroethane

1,1-DCE: 1,1-dichloroethene

1,2-DCA: 1,2-dichloroethane

1,2-DCE (total): total 1,2-dichloroethene

1,2-DCPA: 1,2-dichloropropane

1,3-DCPE (total): total 1,3-dichloropropene

DL: detection limit

DoD: Department of Defense

GC/MS: gas chromatography/mass spectrometry

ICAL: initial calibration

LCS: laboratory control sample

LCSD: laboratory control sample duplicate

LOQ: limit of quantitation

MC: methylene chloride

MS: matrix spike

MSD: matrix spike duplicate

N/A: not applicable

PCE: tetrachloroethene

QC: quality control

QSM: Quality Systems Manual

RPD: relative percent difference

TCE: trichloroethene

VC: vinyl chloride

6.5.2 Worksheet #28b: Metals

Matrix: Groundwater (µg/L)

Analytical Group/Test Method: Metals by EPA Method 6010D

QC Sample	Frequency	Acceptance Limits	Source of Acceptance Limits	Corrective Action	Responsible Person	Data Quality Indicator												
Method Blank	1 per analytical batch	Absolute values of analytes detected < ½ LOQ or < 1/10 the amount measured in any sample or 1/10 the regulatory limit, whichever is greater.	DoD QSM 5.3 App B Table B-8	Correct problem. Re-prepare and re-analyze method blank and affected samples	ICP Analyst	Accuracy/Bias Contamination												
LCS	1 per analytical batch. Spike target compounds	<table border="0"> <tr> <td><u>Analyte</u></td> <td><u>Recovery</u></td> <td></td> </tr> <tr> <td>Antimony</td> <td>88-113%</td> <td></td> </tr> <tr> <td>Copper</td> <td>86-114%</td> <td></td> </tr> <tr> <td>Lead</td> <td>86-113%</td> <td></td> </tr> </table>	<u>Analyte</u>	<u>Recovery</u>		Antimony	88-113%		Copper	86-114%		Lead	86-113%		DoD QSM 5.3 App B Table B-8 and App C Table 4	Re-prepare and re-analyze LCS and associated batch samples	ICP Analyst	Bias Accuracy/Precision
<u>Analyte</u>	<u>Recovery</u>																	
Antimony	88-113%																	
Copper	86-114%																	
Lead	86-113%																	
Laboratory Duplicate Sample	1 per analytical batch	≤ 20%	DoD QSM 5.3 App B Table C-4	Narrate outliers in case narrative. No CA	ICP Analyst	Precision												
MS/MSD	1 per analytical batch	<table border="0"> <tr> <td><u>Analyte</u></td> <td><u>Recovery</u></td> <td><u>RPD</u></td> </tr> <tr> <td>Antimony</td> <td>88-113%</td> <td>≤20%</td> </tr> <tr> <td>Copper</td> <td>86-114%</td> <td>≤20%</td> </tr> <tr> <td>Lead</td> <td>86-113%</td> <td>≤20%</td> </tr> </table>	<u>Analyte</u>	<u>Recovery</u>	<u>RPD</u>	Antimony	88-113%	≤20%	Copper	86-114%	≤20%	Lead	86-113%	≤20%	DoD QSM 5.3 App C Table C-4	Perform additional QC test (dilution test and/or post-digestion spike [PDS]) unless concentrations in parent sample are > 4x the spiked amount (no corrective action required). Perform PDS	ICP Analyst	Bias/Precision
<u>Analyte</u>	<u>Recovery</u>	<u>RPD</u>																
Antimony	88-113%	≤20%																
Copper	86-114%	≤20%																
Lead	86-113%	≤20%																
Dilution Test	1 per prep batch	5-fold dilution must agree within ± 10% of the original measurement	DoD QSM 5.3 App B Table B-8	Perform post-digestion spike	ICP Analyst	Bias/Precision												

QC Sample	Frequency	Acceptance Limits	Source of Acceptance Limits	Corrective Action	Responsible Person	Data Quality Indicator
Post-Digestion Spike (PDS)	Perform if MS/MSD fails, 1 per analytical batch	Recovery within 80-120%	DoD QSM 5.3 App B Table B-8	Run associated samples by method of standard addition or flag data	ICP Analyst	Bias/Precision

Notes:

µg/L: micrograms per liter

ICP: inductively coupled plasma

LOQ: limit of quantitation

PDS: post-digestion spike

RPD: relative percent difference

6.5.3 Worksheet #28c: Wet Chemistry

Matrix: Groundwater (mg/L)

Analytical Group/Test Method: Chloride by EPA Method 9056A

QC Sample	Frequency	Acceptance Limits	Source of Acceptance Limits	Corrective Action	Person Responsible for Corrective Action	Data Quality Indicator
Method Blank	1 per analytical batch	No analytes detected > ½ the LOQ or > ⅒ the amount measured in any sample or ⅒ the regulatory limit	Laboratory limits	Correct problem. Re-prepare and re-analyze method blank and affected samples.	Wet Chemistry Analyst	Accuracy/Bias Contamination
LCS	1 per analytical batch.	<u>EPA 9056A</u> : 90-110%	Laboratory performance-based limits	Re-prepare and re-analyze LCS and associated batch samples.	Wet Chemistry Analyst	Bias Accuracy/Precision
MS/MSD	1 set per analytical batch.	90-110% and RPD ±20%	Lab performance-based limit	Re-prepare and re-analyze MS/MSD samples and report both sets of data. If concentration in parent sample is > 4x the spiked amount, include in case narrative. No CA required.	Wet Chemistry Analyst	Bias/Precision

Notes:

%: percent

LCS: laboratory control sample

mg/L: milligrams per liter

MS/MSD: matrix spike/ matrix spike duplicate

N/A: not applicable

RPD: relative percent difference

7.0 Data Management and Data Review

7.1 Worksheet #29: Project Documentation and Records

Project data and information will be documented, tracked, and managed in a manner to ensure data integrity, defensibility, and retrievability. Project records will be generated from various aspects of the project, including 1) Sample Collection and Field Measurement Records, 2) Analytical Records, and 3) Data Assessment Records. Project data and information are stored in the Fort Ord Administrative Record located at Building 4463, Room 101, Gigling Road, Seaside, California. The Administrative Record is managed by the Army and will be maintained until site closure, at which time disposition of site records will be determined by the Army.

7.1.1 Sample Collection and Field Measurement Records

At a minimum, the following documentation will be used for sample collection and field measurement activities. Examples of field forms are presented in Attachment B.

- Field Activity Daily Logbook – A bound Field Activity Daily Logbook (FADL) with sequentially numbered pages will be used for field documentation of key sampling and analytical activities associated with the Sites 2/12 and OU2 GWTS and the Sites 2/12, OU2, and OUCTP GWMP. The FADL will contain information to include:
 - Name and company of sampling technician
 - Date, time, and location of sample collection
 - Site observations and remarks related to sampling activities
 - Field equipment calibration documentation
- Groundwater Level Field Data Sheets – are used to record depth to groundwater measurements, and include the following information:
 - Sampling station name, date, and time of measurement
 - Depth to water (DTW) sounder serial number and documented calibration differential from steel tape
 - Samplers initials
 - Measured depth to water
 - Historical average DTW and total depth of well which are used to verify the measured reading in the field
- Groundwater Sampling Forms – are used to record collection of groundwater samples. Groundwater samples from the Sites 2/12, OU2 and OUCTP GWMP are collected via PDBs, Westbay multi-port wells, and sampling ports, while samples from the Sites 2/12 and OU2 GWTS are primarily collected via sampling ports. Each of these sampling systems has a designated groundwater sampling form, specific to the data needed for each sampling method; however, each groundwater sampling form will contain the same essential information:

- Name of sampling technician
 - Date and time of sample collection
 - Depth to water (where applicable)
 - Depth of sample collection (or port number, or bag number)
 - Method of sample collection
 - Volume of sample collected
 - Preservation of samples (if any)
 - Analysis requested
 - QC samples collected at the sampling station
- Sample Labels – Sample labels will be affixed to each sample container upon collection and prior to transfer to the laboratory. Each sample will be assigned a unique sample identification number. The sample label will include the following information:
 - Project name, number, and location
 - Site name
 - Name of collector
 - Date and time of collection
 - Sample identification number
 - Sample preservation
- Chain of Custody Forms – A chain of custody form will be completed for every sample collected and submitted to the analytical laboratory to document custody of the sample from the time of collection to receipt at the laboratory. Chain of custody forms will be completed in duplicate (at a minimum) so one copy is sent to the Project Manager or designee and one copy accompanies the samples submitted to the analytical laboratory. The laboratory will send the Project Chemist, or designee, a copy of the completed chain of custody along with a completed Cooler Receipt Form (CRF) and completed log-in information within 24 hours of sample receipt and log-in. The chain of custody will include the following information:
 - Name, number, and location of project
 - Project Manager or “Report to” contact
 - Name and signature of sample collector, sampler, or recorder
 - Date and time of sample collection
 - Sample type/matrix
 - Number of containers submitted and preservative used (if any)
 - Analyses requested and TAT requirements
 - Signature trail of persons relinquishing and receiving samples
 - Receiving laboratory address and contact information
 - Date and time of sample receipt

7.1.2 Analytical Records

The analytical laboratory will maintain and submit the following records as part of the data deliverable for each sample. These records together make up the Comprehensive Certificate of Analysis, which is a required deliverable to report results and is used in the data validation process.

- Chain of custody records
- Sample/Cooler Receipt Forms (SRFs/CRFs) documenting the general condition of the samples upon receipt including temperature, sample preservation, and number of containers received as well as any discrepancies or issues
- Sample tracking forms
- Sample preparation and analysis forms/logbooks
- Tabulated data summary forms and raw data for field samples, QC samples, and standards. If manual integration is performed on project samples, raw data to include chromatographs from before and after manual integration is applied. The case narrative will also address the reason manual integration was performed on each affected sample
- Case narrative
- Date and times of sample receipt, extraction, and analysis
- QC sample results
- Communication logs
- Corrective action reports
- Definitions of laboratory qualifiers
- Instrument calibration data and summary reports
- Signatures for laboratory sign-off

7.1.3 Project Data Assessment Records

Project data assessment records will be generated and submitted as part of the quarterly or annual reporting requirements for the Sites 2/12, OU2, OUCTP GWMP and the Sites 2/12 and OU2 GWTS as necessary. Project Data Assessment reports may be created at any time throughout the project, and typically consist of the following:

- Field Sampling Audit Report (if applicable)
- Laboratory Audit Report (if applicable)
- Data Validation Summary Report

7.2 Worksheets #31, #32, and #33: Assessments and Corrective Action

Planned project assessments will be completed for the Sites 2/12 and OU2 GWTS and Sites 2/12, OU2, and OUCTP GWMP through the Three Phase QC Process, as follows:

- Preparatory Phase: Activities and assessments conducted during the preparatory phase are conducted prior to the start of a feature of work to ensure technical requirements and work prerequisites have been completed. Discrepancies will be resolved and corrective actions implemented and verified prior to the start of work.
- Initial Phase: Activities and assessments conducted during the initial phase are performed during the first day of the feature of work to verify compliance with the specifications and requirements described in this QAPP and approved project plans and procedures. Discrepancies will be resolved and corrective actions implemented and verified prior to work proceeding.
- Follow-Up and Reporting Phase: Activities and assessments performed during the follow-up and reporting phase are conducted to verify continued compliance with project requirements and to verify project reports meet client and regulatory requirements.

An overview of the Three Phase QC Process and related forms used to document the process are provided in Attachment C. The activities and assessments conducted during each phase of the Three Phase QC Process are described below.

7.2.1 Assessments and Corrective Action

Assessment Type	Nature of Deficiencies Documentation	Individual(s) Notified of Findings (Name, Title, Organization)	Timeframe of Notification	Nature of Corrective Action Response Documentation	Individual(s) Receiving Corrective Action Response (Name, Title, Organization)	Timeframe for Response
Phase I – Preparatory Phase						
Planning Document review	Internal Memo	Document Author	Prior to the start of field activities	Response to comments documentation and USACE approval of document as applicable	Derek Lieberman, PM, Ahtna	One week
Planning document (QAPP) sign-off by field and laboratory	Memo	Stephen Korbay, Field Supervisor, Ahtna Elvin Kumar, PM, SGS	Prior to the start of field activities	Obtain sign-off that document has been read and understood by field and lab personnel	Eric Schmidt, Project Chemist, Ahtna	One week
Review of lab and field personnel readiness	Memo	Stephen Korbay, Field Supervisor, Ahtna Elvin Kumar, PM, SGS	Prior to the start of field activities	Provide kickoff meeting notes from field and lab meetings	Eric Schmidt, Project Chemist, Ahtna	One week
Review of field equipment	Memo	Stephen Korbay, Field Supervisor, Ahtna	Prior to the start of field activities	Provide checklist documenting field equipment is available and in good working order	Eric Schmidt, Project Chemist, Ahtna	Prior to the start of field activities
Phase II – Initial Phase						

Assessment Type	Nature of Deficiencies Documentation	Individual(s) Notified of Findings (Name, Title, Organization)	Timeframe of Notification	Nature of Corrective Action Response Documentation	Individual(s) Receiving Corrective Action Response (Name, Title, Organization)	Timeframe for Response
Field and laboratory audit	Field and lab audit report	Stephen Korbay, Field Supervisor, Ahtna Elvin Kumar, PM, SGS Derek Lieberman, PM, Ahtna	Within 48 hours of audits	Field and laboratory to issue a formal response to audit findings requiring corrective action	Eric Schmidt, Project Chemist, Ahtna	One week
Review of Contractor QC Reports	Memo	Stephen Korbay, Field Supervisor, Ahtna Bruce Wilcer, QC Manager, Ahtna	Within 48 hours of review	Revision of Contractor QC Reports (CQCRs) as needed	Derek Lieberman, PM, Ahtna	One week

Assessment Type	Nature of Deficiencies Documentation	Individual(s) Notified of Findings (Name, Title, Organization)	Timeframe of Notification	Nature of Corrective Action Response Documentation	Individual(s) Receiving Corrective Action Response (Name, Title, Organization)	Timeframe for Response
Review of project plans to reflect current site or lab activities	Memo	Holly Dillon, Task Lead, Ahtna Stephen Korbay, Field Supervisor, Ahtna Elvin Kumar, PM SGS	Within 10 days of observations	Update project plans to reflect current conditions (may be an addendum to existing document) or documentation of changes to field or lab protocol to be in accordance with project plans	Derek Lieberman, PM, Ahtna	Prior to next scheduled sampling event
Phase III – Follow-Up and Reporting Phase						
Review of Data Reports	Internal comments from staff and external comments from client and regulatory agencies	Document Author Derek Lieberman, PM, Ahtna	Internal = prior to issuance of report External = within 30 days of receipt of report	Provide response to comments and revise report as needed	Commenting client and/or agencies Bridget Floyd, Technical Lead, USACE	30 days

7.2.2 QA Management

Type of Report	Frequency (daily, weekly monthly, quarterly, annually, etc.)	Projected Delivery Date(s)	Person(s) Responsible for Report Preparation (Title and Organizational Affiliation)	Report Recipient(s) (Title and Organizational Affiliation) ²⁰
Sites 2/12 GWMP and GWTS O&M Reports	Quarterly	Final 60 days after end of quarterly sampling event	Derek Lieberman, PM, Ahtna Holly Dillon, Task Lead, Ahtna	USACE: Dana Gentry – PM, Jonathan Whipple – Project Chemist, Bridget Floyd – Technical Lead Fort Ord BRAC: William Collins – BRAC Environmental Coordinator (BEC) Chenega – Field Oversight Inspector Fort Ord Administrative Record EPA: Maeve Clancy – PM TechLaw: Joe Carter CCRWQCB: Amber Sellinger – PM DTSC: Min Wu – PM
	Annually	Preliminary Draft 60 days after end of annual sampling event		
OU2 GWMP and GWTS O&M Reports	Quarterly	Final 60 days after end of quarterly sampling event	Derek Lieberman, PM, Ahtna Holly Dillon, Task Lead, Ahtna	USACE: Dana Gentry – PM, Jonathan Whipple – Project Chemist, Bridget Floyd – Technical Lead Fort Ord BRAC: William Collins – BRAC Environmental Coordinator (BEC) Chenega – Field Oversight Inspector Fort Ord Administrative Record EPA: Maeve Clancy – PM TechLaw: Joe Carter CCRWQCB: Amber Sellinger – PM DTSC: Min Wu – PM
	Annually	Preliminary Draft 60 days after end of annual sampling event		
OUCTP GWMP Reports	Quarterly	Final 60 days after end of quarterly sampling event	Derek Lieberman, PM, Ahtna Holly Dillon, Task Lead, Ahtna	USACE: Dana Gentry – PM, Jonathan Whipple – Project Chemist, Bridget Floyd – Technical Lead Fort Ord BRAC: William Collins – BRAC Environmental Coordinator (BEC) Chenega – Field Oversight Inspector Fort Ord Administrative Record EPA: Maeve Clancy – PM TechLaw: Joe Carter CCRWQCB: Amber Sellinger – PM DTSC: Min Wu – PM
	Annually	Preliminary Draft 60 days after end of annual sampling event		
CQCR	Quarterly, following each sampling event	Within 60 days of completion of field sampling event	Holly Dillion, Task Lead, Ahtna	USACE: Dana Gentry – PM, Jonathan Whipple – Project Chemist, Bridget Floyd – Technical Lead Chenega: Field Oversight Inspector Ahtna: Derek Lieberman, Project Manager

²⁰ Chenega Field Oversight Inspector will use Fort Ord Administrative Record copies of documents.

Type of Report	Frequency (daily, weekly monthly, quarterly, annually, etc.)	Projected Delivery Date(s)	Person(s) Responsible for Report Preparation (Title and Organizational Affiliation)	Report Recipient(s) (Title and Organizational Affiliation) ²⁰
Non-Routine Occurrences Report	As needed	Within 48 hours of a Non-Routine Occurrence in the field or laboratory. A copy of this report will also be included in the CQCR	Eric Schmidt, Project Chemist, Ahtna	USACE: Dana Gentry, PM; Jonathan Whipple, Project Chemist; Bridget Floyd, Technical Lead Ahtna: Eric Schmidt, Project Chemist Chenega: Field Oversight Inspector
Field Work Variance Report	As needed	Prior to implementation of proposed change or immediately following a variance implemented in the field. A copy of the Field Work Variance will also be included in the CQCR	Stephen Korbay, Field Task Manager, Ahtna	USACE: Dana Gentry, PM; Jonathan Whipple, Project Chemist; Bridget Floyd, Technical Lead Ahtna: Derek Lieberman, PM; Eric Schmidt, Project Chemist Chenega: Field Oversight Inspector
Validation Summary Report	Quarterly, following each sampling event	Produced as part of the Quarterly Monitoring Report	Eric Schmidt, Project Chemist, Ahtna	USACE: Dana Gentry, PM; Jonathan Whipple, Project Chemist; Bridget Floyd, Technical Lead Fort Ord BRAC: William Collins, BEC Fort Ord Administrative Record EPA: Maeve Clancy, PM TechLaw: Joe Carter CCRWQCB: Amber Sellinger, PM DTSC: Min Wu, PM

7.3 Worksheet #34: Data Verification and Validation Inputs

Verification Input	Description	Internal / External	Responsible for Verification (Name, Organization)
Chain of custody and shipping forms	Chain of custody forms will be reviewed internally upon their completion and verified against the packed sample coolers they represent. When everything is verified, the shipper's signature on the chain of custody form will be initialed by the reviewer. A copy of the form will be retained in the site file, and the original and remaining copies will be taped inside the cooler for shipment. Refer to Attachment A for SOPs #4 and #7 for further detail.	I	Sites 2/12 and OU2 GWTS: Mark Fisler, O&M Manager, Ahtna Sites 2/12, OU2, OUCTP GWMP: Stephen Korbay, Field Supervisor, Ahtna
	Receiving laboratory will verify chain of custody forms with contents of coolers. Ahtna project chemist will be notified of any discrepancies or issues within 24 hours of sample receipt. Resolution will be documented in writing and submitted with final data package.	E	Elvin Kumar, Project Manager, SGS
	Laboratory receipt/log-in report will be reviewed against chain of custody internally.	I	Sites 2/12 and OU2 GWTS: Teri Farrell, Data Manager, Ahtna Sites 2/12, OU2, OUCTP GWMP Laboratory Data Consultants, Data Validators
Field Notes	Field notes will be reviewed internally by the field supervisor for consistency with the chain of custody forms and SOPs. One copy of the field notes will be retained in the onsite project file, and originals will be forwarded to the Project Manager for review.	I	Sites 2/12, OU2 GWTS: Mark Fisler, O&M Manager, Ahtna Sites 2/12, OU2, OUCTP GWMP: Stephen Korbay, Field Supervisor, Ahtna

Verification Input	Description	Internal / External	Responsible for Verification (Name, Organization)
Laboratory Data	Analytical data packages will be verified by the laboratory performing the work for completeness prior to submittal.	I	Svetlana Izosimova, QA Officer, SGS
	Received data packages will be verified according to the data validation procedures specified in Worksheet #35. Laboratory electronic deliverables will be verified against the data package hard copy reports.	I	Sites 2/12, OU2 GWTS: Eric Schmidt, Project Chemist, Ahtna Sites 2/12, OU2, OUCTP GWMP: Laboratory Data Consultants

7.4 Worksheet #35: Data Verification Procedures

Stage 2A/2B	Validation Input	Description	Responsible for Verification – GWTS	Responsible for Verification – GWMP
2A	Methods used for sample collection	Field data notes will be reviewed for compliance with published methods and SOPs. Deviations from SOPs and methods described in this QAPP will be summarized and provided to the Project Manager in writing.	Mark Fidler, O&M Manager, Ahtna	Stephen Korbay, Field Supervisor, Ahtna
2A	Methods used for analysis	Laboratory data packages will be reviewed to verify the methods specified in this QAPP were followed. Deviations shall be documented in writing.	Eric Schmidt, Project Chemist, Ahtna	Laboratory Data Consultants
2A	Sampling SOPs and Analytical Compliance	Review field notes for compliance with SOPs. Review laboratory data deliverables for compliance with QAPP and published methods.	Holly Dillon, Task Lead, Ahtna Eric Schmidt, Project Chemist, Ahtna	Stephen Korbay, Field Supervisor, Ahtna
2A	Documentation of method QC results	Review laboratory data packages to determine if QC parameters required by the referenced methods were performed and reported. The QC forms will be reviewed to determine if method acceptance criteria were met. Method QC outliers will be identified by the laboratory in the case narrative. Reviewer will determine if data will require qualification due to outliers.	Eric Schmidt, Project Chemist, Ahtna	Laboratory Data Consultants, Inc.
2B	Documentation of QAPP QC sample results	Verify QC samples specified in this QAPP were analyzed and reported. Reviewer will identify QAPP QC sample results in the data validation report.	Eric Schmidt, Project Chemist, Ahtna	Laboratory Data Consultants

Stage 2A/2B	Validation Input	Description	Responsible for Verification – GWTS	Responsible for Verification – GWMP
2B	Laboratory data package documentation	Laboratory data packages will be reviewed to ensure documentation requirements specified in the QAPP have been met. If deficiencies are found, the Data Reviewer will document the issue in a memorandum to the laboratory. The laboratory will address deficiencies in writing or submit a revised data package correcting the deficiencies.	Eric Schmidt, Project Chemist, Ahtna	Laboratory Data Consultants
2B	Target analyte list	Laboratory report summary forms will be reviewed to verify the target compounds and parameters specified in the QAPP were reported.	Eric Schmidt, Project Chemist, Ahtna	Laboratory Data Consultants
2B	LOQs	Determine quantitation limits were achieved, as outlined in the QAPP. Verify the laboratory analyzed a low standard at the quantitation limit in the initial calibration.	Eric Schmidt, Project Chemist, Ahtna	Laboratory Data Consultants
2A	Raw data and laboratory transcription errors	Ten percent (10%) of raw data will be reviewed to confirm laboratory calculations and that there are no transcription errors. Chromatographs containing manual integrations, if any, will be evaluated as part of the raw data review.	Eric Schmidt, Project Chemist, Ahtna	Laboratory Data Consultants
2A and 2B	Data Validation Report	Summarize deviations from the referenced methods, SOPS, and QAPP-specific requirements. Include qualified data and explanations of all data qualifiers.	Eric Schmidt, Project Chemist, Ahtna	Laboratory Data Consultants
2A and 2B	Data Validation Report Review	Review validation reports and Validation Summary Report.	Eric Schmidt, Project Chemist, Ahtna	Laboratory Data Consultants

7.5 Worksheet #36: Data Validation Procedures

Analytical data will undergo 100% automatic stage 2B validation, plus 10% stage 4 validation. A detailed description of the laboratory analytical data verification and validation stages and checks is provided in Appendix A of EPA 540-R-08-005, Guidance for Labeling Externally Validated Laboratory Analytical Data for Superfund Use (EPA, 2009).

Stage 2A/2B	Matrix	Analytical Group	Validation Criteria	GWTS Validator	GWMP Validator
2A	Aqueous	VOCs	EPA 540-R-08-005 and SW-846 Method 8260-SIM	Eric Schmidt, Project Chemist, Ahtna	Laboratory Data Consultants
2B	Aqueous	VOCs	QAPP Worksheets and ADR Library	Eric Schmidt, Project Chemist, Ahtna	Laboratory Data Consultants
2A	Aqueous	Dissolved metals	EPA 540-R-08-005 and SW-846 Method 6010D	Eric Schmidt, Project Chemist, Ahtna	Laboratory Data Consultants
2B	Aqueous	Dissolved Metals	QAPP Worksheets and ADR Library	Eric Schmidt, Project Chemist, Ahtna	Laboratory Data Consultants
2A	Aqueous	Wet Chemistry	EPA 540-R-08-005, EPA Method 9056A (chloride)	Eric Schmidt, Project Chemist, Ahtna	Laboratory Data Consultants
2B	Aqueous	Wet Chemistry	QAPP Worksheets and ADR Library	Eric Schmidt, Project Chemist, Ahtna	Laboratory Data Consultants

Notes:

ADR: Automated Data Review program

7.6 Worksheet #37: Data Usability Assessment

The suitability of the environmental data collected from both the Sites 2/12 and OU2 GWTS and the Sites 2/12, OU2, and OUCTP GWMP will be assessed by the Ahtna Project Chemist. Data usability will comprise an evaluation of the quantity, type, and overall quality of the generated data against the project DQOs as presented in Worksheet #11 and the MPC presented in Worksheet #12. The usability of data associated with QC results outside of the established acceptance criteria is dependent on the degree of the exceedance, whether the potential bias is high or low, and whether the uncertainty implied by the exceedance is significant relative to project decisions and DQOs. Data usability will be assessed in accordance with the guidance provided in the DoD QSM Version 5.3 and additional applicable USACE and EPA guidance as well as the professional experience of the decision-maker during data validation. The following items will be assessed and conclusions drawn based on their results:

- **Precision** – Duplicate field and laboratory samples will be evaluated for precision based on relative percent difference (RPD). RPD will be calculated for each detectable result between the two samples. RPDs exceeding MPC in Worksheet #12 will be identified in the Validation Summary Report and any limitations on the use of the data will be noted. RPDs within the MPC will demonstrate the data have acceptable precision and the data are usable.
- **Accuracy** – LCS/LCSD, MS/MSD sample results will be evaluated by comparing spike recovery results with MPC in Worksheet #12.
- **Sensitivity** – Data sensitivity will be verified by comparing method blank results with MPC in Worksheet #12 and cross-checking analyte data with LOQs and ACLs presented in Worksheet #15a.
- **Bias** – Laboratory surrogate compound recovery will be evaluated for bias by comparing results with MPC in Worksheet #12.
- **Contamination** – Field blank, trip blank, and method blank data will be used to determine whether there are contamination issues based upon MPC in Worksheet #12.
- **Representativeness** – Sampling procedures will be implemented in accordance with SOPs to eliminate or minimize sources of error. Compliance with SOPs will be confirmed through QC field audits. Analytical procedures will be implemented in accordance with laboratory SOPs, QC acceptance limits, and the laboratory QA Manual. Laboratories used for sample analysis will maintain DoD ELAP certification and undergo annual audits by the independent accrediting bodies responsible for the DoD ELAP certification.
- **Completeness** – The completeness of the sample event will be determined based upon the number of field samples collected compared to the number of samples planned and the number of unqualified laboratory results compared to the total number of results.²¹ This information will be compared to MPC in Worksheet #12.

²¹ Results qualified as estimated due to detected quantities between the LOQ and LOD will not be counted in the analytical completeness quantity assessment.

- **Comparability** – The data from each sampling event are comparable to past and future events as long as the same or similar sampling and analytical SOPs located in Attachment A are utilized.
- **Reconciliation** – Each of the DQOs presented in Worksheet #11 will be examined to determine whether the objectives were met. This examination will include a combined overall assessment of the results of each analysis pertinent to an objective. Each analysis will be first evaluated separately in terms of the major impacts observed from the data validation, DQIs, and MPC assessments. Based on the results of these assessments, the quality of the data will be determined. Based on the quality, data usability for each analysis will be determined. Based on the combined data usability from all analyses for an objective, it will be determined whether the DQO was met and whether action limits were exceeded.

In the event the data quantity or quality prove to be inadequate to meet project objectives, re-analysis or re-sampling may be required. Replacement samples may be collected when existing data are insufficient or inadequate to support project objectives. The decision to collect replacement samples will be made in coordination with the project team and may include USACE, Ahtna Project Managers, and the Ahtna Project Chemist.

Usability of the data will be presented in the Validation Summary Report, included with each Quarterly Monitoring Report. Copies of the associated data validation reports will be presented as an attachment to the Validation Summary Report. The Validation Summary Report will contain the following information:

- Basic summary of validation results, including a summary of data qualified with validation flags as listed in Attachment D
- Summary of deviations from the QAPP
- Summary of rejected data that resulted in a data gap
- Summary of points that went into the reconciliation of each objective
- Comments on recovery issues with the MS/MSDs
- Comments on limitations on the data usability
- Comments on corrective action needed and/or taken
- Conclusions and recommendations

8.0 References²²

- Ahtna Environmental Services (AES), 2009. *Final Operations and Maintenance Manual Volume II, Sites 2 and 12 Groundwater Remedy, Former Fort Ord, California* (Sites 2/12 GWTS O&M Manual). August. AR# [BW-2479G](#).
- AES, 2014. *Final Operable Unit Carbon Tetrachloride Plume Remedial Action Work Plan, Former Fort Ord, California; Appendix A Operable Unit Carbon Tetrachloride Plume A-Aquifer Remedial Design Addendum*. April. AR# [OUCTP-0062A](#).
- AES, 2015. *Final Remedial Investigation/Feasibility Study Addendum at Sites 2 and 12, Former Fort Ord, California*. February 27. AR# [BW-2721B](#). Ahtna Environmental, Inc. (AEI), 2019. *Monitoring Well Installation Completion Report, Former Fort Ord, California*. July 8. AR# [BW-2866A](#).
- Ahtna Global, LLC (Ahtna), 2020a. *Quality Assurance Project Plan, Former Fort Ord, California, Volume I, Appendix C, Final Revision 5, Soil Gas Monitoring at Sites 2 and 12*. August 14. AR# [BW-2792M](#).
- Ahtna, 2020b. *Quality Assurance Project Plan, Former Fort Ord, California, Volume I, Appendix D, Final Revision 4, Operable Unit 2 Landfills*. May 1. AR# [OU2-702K](#).
- Ahtna, 2021a. *Draft Sites 2 and 12 Fourth Quarter 2019 through Third Quarter 2020 Groundwater and Soil Gas Monitoring and Treatment System Report, Former Fort Ord California*. April 23. AR# BW-2894.
- Ahtna, 2021b. *Operable Unit 2 Remedy Monitoring and Operations and Maintenance, Fourth Quarter 2019 through Third Quarter 2020, Former Fort Ord, California*. June. AR# OU2-TBD.
- Ahtna, 2021c. *Draft Operable Unit Carbon Tetrachloride Plume Fourth Quarter 2019 through Third Quarter 2020 Groundwater Monitoring Report, Former Fort Ord, California*. June. AR# [OUCTP-TBD](#).
- Dames & Moore, 1993. *Baseline Risk Assessment, Remedial Investigation/Feasibility Study, Site 2 Landfills, Fort Ord, California*. June 7. AR# [OU2-218](#).
- Department of Defense (DoD), 2019a. *Consolidated Quality Systems Manual (QSM) for Environmental Laboratories, Version 5.3*. <https://denix.osd.mil/edqw/documents/manuals/qsm-version-5-3-final/>
- DoD, 2019b. *General Data Validation Guidelines, Environmental Data Quality Workgroup*. September 16.
- Fort Ord Reuse Authority (FORA), 1997. *Fort Ord Reuse Plan, Volume I: Context and Framework*. June. http://www.fora.org/Reports/BRP/BRP_v1_ContextAndFramework_1997.pdf
- Harding ESE, 2001. *Technical Memorandum, Passive Diffusion Bag Pilot Study Results and Recommendations*. July 25. AR# [BW-2099](#).

²² At the end of references included in the Fort Ord Administrative Record are the Administrative Record Numbers (AR#s) (e.g. BW-1234). To find the referenced document, this number may be typed into the online search tool at: <http://www.fortordcleanup.com/documents/search/>. Please note the referenced documents were available in the Fort Ord Administrative Record at the time this document was issued; however, some may have been superseded by more current versions and were subsequently withdrawn. TBD: to be determined.

- Harding Lawson Associates (HLA), 1995. *Final Basewide Remedial Investigation/Feasibility Study, Fort Ord, California, Volume II – Remedial Investigation, Basewide Hydrogeologic Characterization*. October 19. AR# [BW-1283A](#).
- HLA, 1999. *Draft Final Revised Treatment System Plan, OU2 Groundwater Remedy, Fort Ord, California*. January 29. AR# [OU2-584](#).
- Intergovernmental Data Quality Task Force (IDQTF), 2005. *Uniform Federal Policy for Quality Assurance Project Plans, Part 1: UFP-QAPP Manual, Final Version 1*. March.
<https://www.epa.gov/fedfac/assuring-quality-federal-cleanups#ufp-qapp>
- IDQTF, 2012. *Uniform Federal Policy for Quality Assurance Project Plans, Part 2a, Revision 1: Optimized UFP-QAPP Worksheets*. March. <https://www.epa.gov/fedfac/assuring-quality-federal-cleanups#ufp-qapp>
- MACTEC Engineering and Consulting, Inc. (MACTEC), 2009. *Final Technical Memorandum, Groundwater Remediation Exit Strategy, Sites 2 and 12 and OU2, Former Fort Ord, California*. July 20. AR# [BW-2485H](#).
- Monterey County Water Resources Agency (MCWRA), 2017. *Recommendations to Address the Expansion of Seawater Intrusion in the Salinas Valley Groundwater Basin*. October.
<http://www.co.monterey.ca.us/home/showdocument?id=57432>
- RORE Innovative Solutions Joint Venture (JV), 2019. *Operations and Maintenance Manual, Operable Unit 2 (OU 2) Groundwater Treatment Plant, Former Fort Ord (OU2 GWTP O&M Manual)*. March.
- U.S. Department of the Army (Army), 1994. *Record of Decision, Operable Unit 2, Fort Ord Landfills, Fort Ord, California*. July 15. AR# [OU2-480](#).
- Army, 1995. *Explanation of Significant Differences, Operable Unit 2, Fort Ord Landfills, Fort Ord, California*. August 3. AR# [OU2-406](#).
- Army, 1997. *Record of Decision, Basewide Remedial Investigation Sites, Fort Ord, California*. January 13. AR# [RI-025](#).
- Army, 2008. *Record of Decision, Operable Unit Carbon Tetrachloride Plume, Former Fort Ord, California*. February 6. AR# [OUCTP-0021D](#).
- Army, 2016. *Explanation of Significant Differences No. 1, Basewide Remedial Investigation Sites 2 and 12, Former Fort Ord, California*. February 1. AR# [BW-2794](#).
- U.S. Environmental Protection Agency (EPA), 2006. *Guidance on Systematic Planning Using the Data Quality Objectives Process, EPA QA/G-4*. February. <https://www.epa.gov/fedfac/guidance-systematic-planning-using-data-quality-objectives-process>
- EPA, 2009. *Guidance for Labeling Externally Validated Laboratory Analytical Data for Superfund Use*. January. OSWER No. 9200.1-85, [EPA 540-R-08-005](#).
- EPA, 2013. *Guidance for Evaluating Completion of Groundwater Restoration Remedial Actions*. November. [OSWER 9355.0-129](#).



EPA, 2014a. *Groundwater Remedy Completion Strategy, Moving Forward with the End in Mind*. May. [OSWER 9200.2-144](#).

EPA, 2014b. *Recommended Approach for Evaluating Completion of Groundwater Restoration Remedial Actions at a Groundwater Monitoring Well*. August. [OSWER 9283.1-44](#).

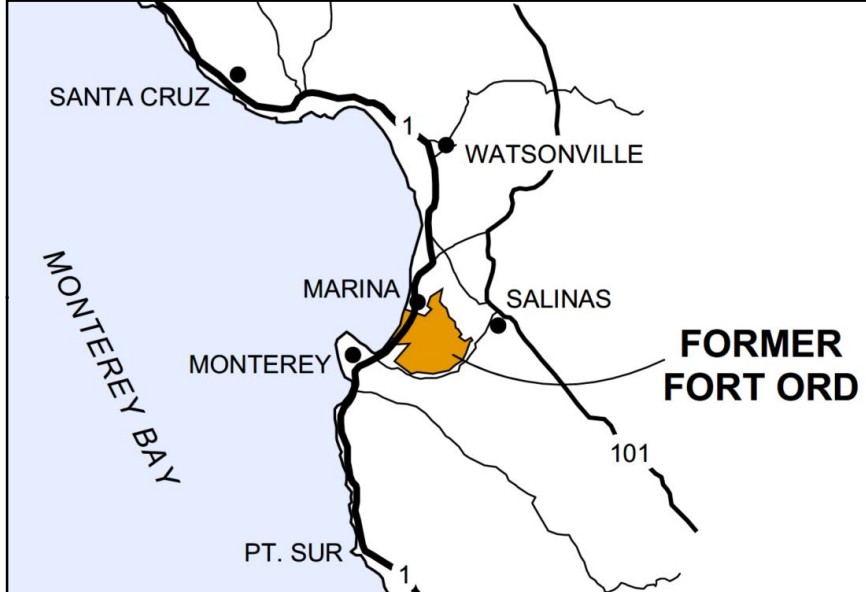
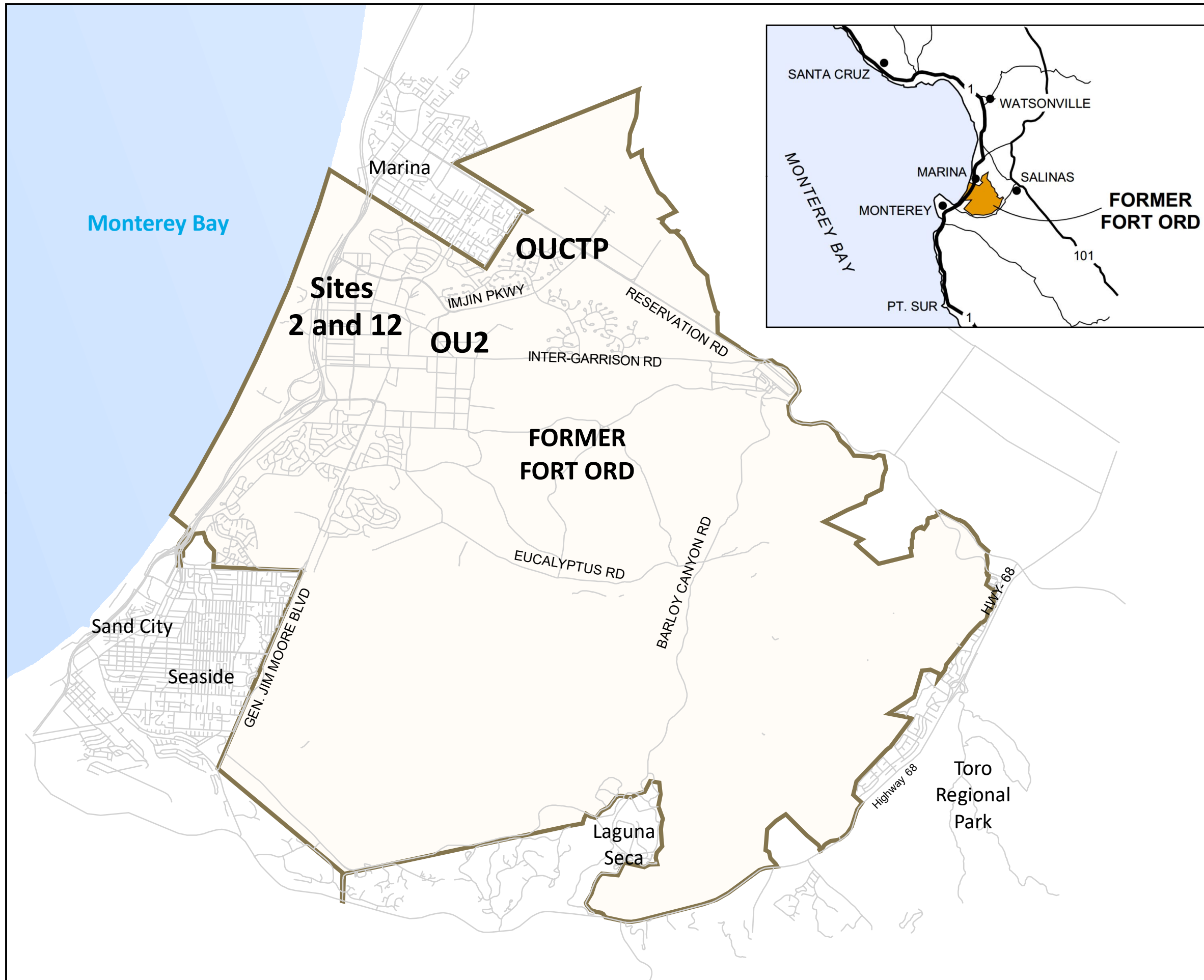
FIGURES



EXPLANATION

-  Former Fort Ord Boundary
-  Roads

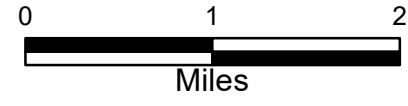
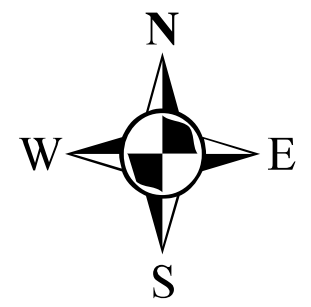

Former Fort Ord
 Location Map
 Quality Assurance Project Plan
 Former Fort Ord, California
 Volume 1, Appendix A, Revision 9
 Groundwater Remedies and Monitoring at Operable Unit 2,
 Sites 2 and 12, and Operable Unit Carbon Tetrachloride.



EXPLANATION

Well Type and Sample Schedule

- Extraction Well - Quarterly VOCs
- Monitoring Well - Quarterly VOCs
- Monitoring Well - Annual VOCs
- Extraction Well - Water Levels
- Monitoring Well - Water Levels
- Roads

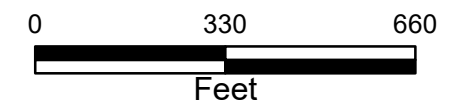
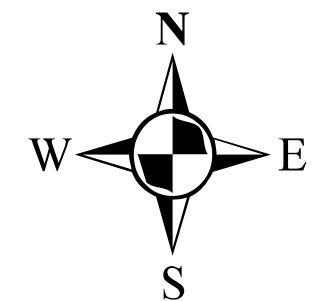

Sites 2 and 12
 Groundwater Monitoring Program
 Sample Locations
 Quality Assurance Project Plan
 Former Fort Ord, California
 Volume 1, Appendix A, Revision 9
 Groundwater Remedies and Monitoring at Operable Unit 2,
 Sites 2 and 12, and Operable Unit Carbon Tetrachloride.

Ahtna

May 24, 2021

Figure: **2**



EXPLANATION

- Well Type and Use**
- Extraction Well - Operated
 - Extraction Well - Not Operated
 - Extraction Well - Not Operated - No Pump
- Groundwater Pipeline**
- Sites 2/12 Groundwater Collection Pipeline
 - OU2 Treated Water Injection Pipeline
 - Combined Treatment Water Discharge
 - Sites 2/12 GWTP
- Discharge Structures**
- Infiltration Well
 - Injection Well
 - Road
 - Former Fort Ord Boundary

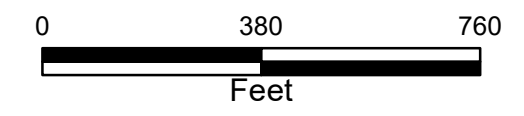
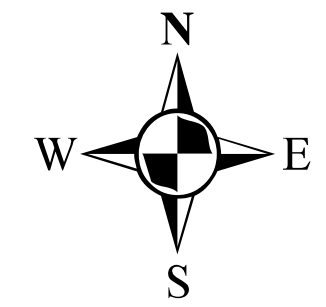

Sites 2/12
 Groundwater Remedy Map
 Quality Assurance Project Plan
 Former Fort Ord, California
 Volume 1, Appendix A, Revision 9
 Groundwater Remedies and Monitoring at Operable Unit 2,
 Sites 2 and 12, and Operable Unit Carbon Tetrachloride.

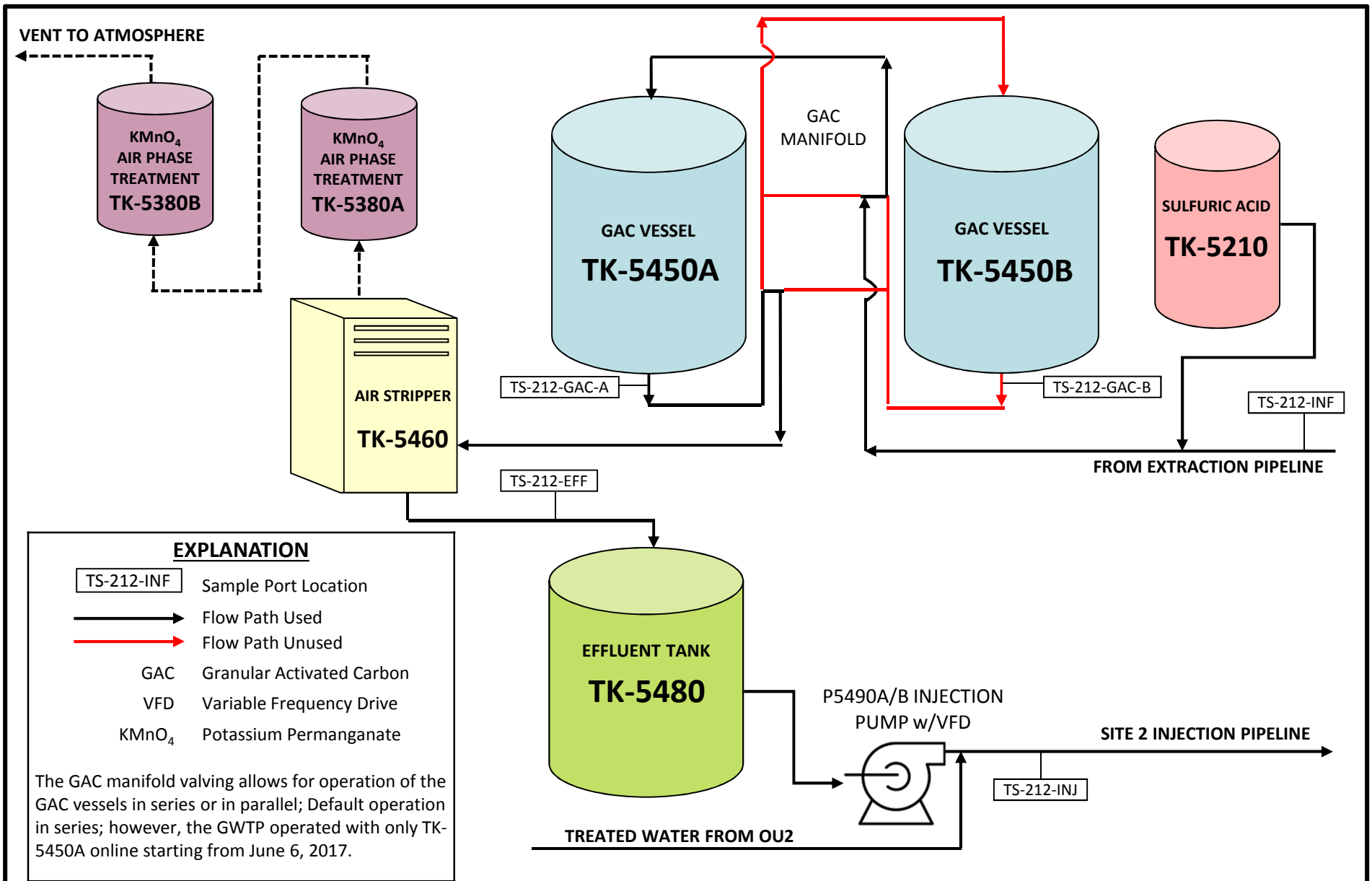

Ahtna

Sites 2/12 Groundwater Treatment Plant Schematic

Quality Assurance Project Plan, Former Fort Ord, California, Volume I, Appendix A, Revision 9
Groundwater Remedies and Monitoring at Operable Unit 2, Sites 2 and 12, and
Operable Unit Carbon Tetrachloride Plume

Figure:

4

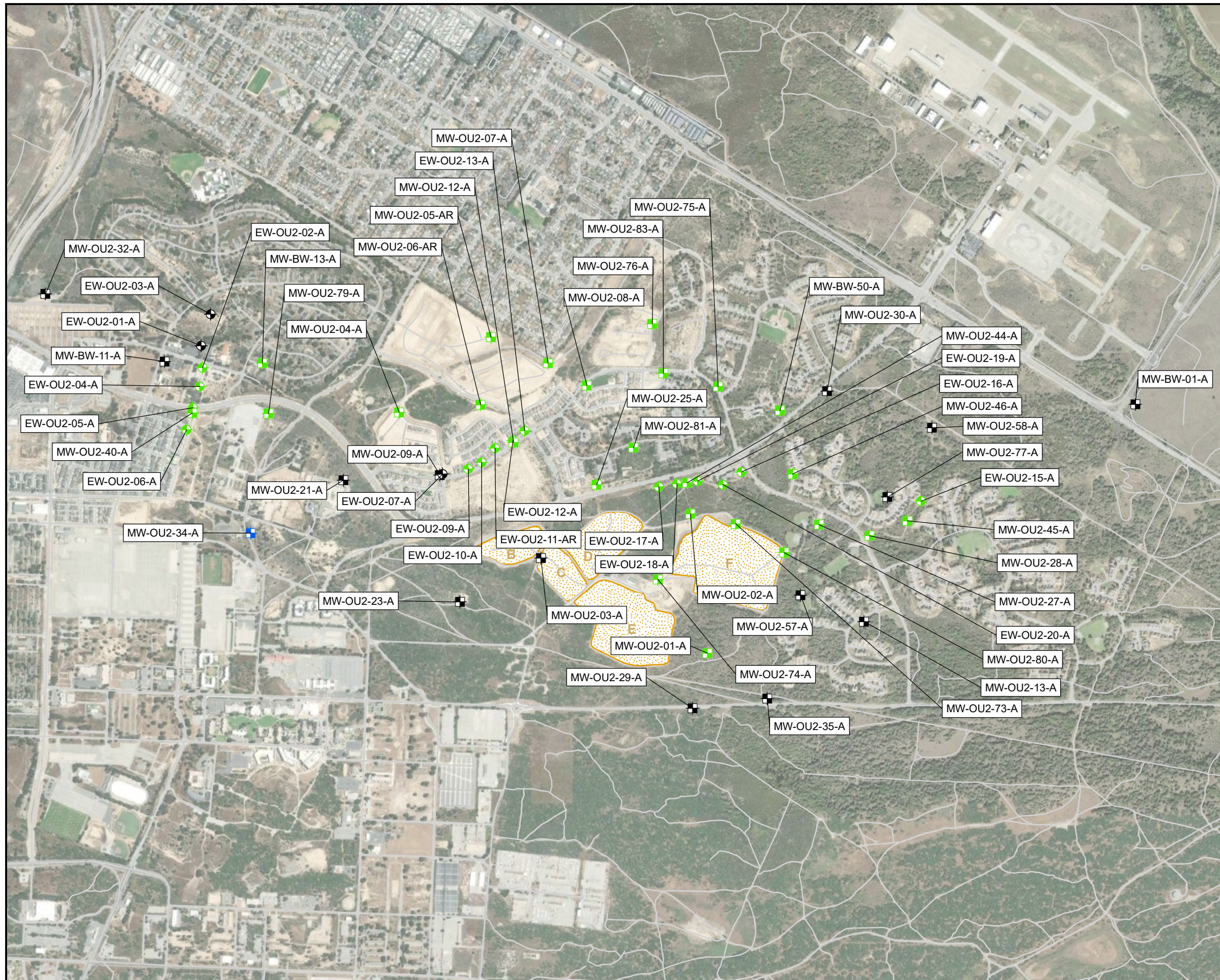

EXPLANATION

Well Type and Sample Schedule

- Extraction Well - Quarterly VOCs
- Monitoring Well - Quarterly VOCs
- Monitoring Well - Annual VOCs
- Extraction Well - Water Levels
- Monitoring Well - Water Levels
- Roads
- Fort Ord Landfills (Areas B - F)

NOTE:
 *MW-OU2-05-AR has not been surveyed due to construction.
 **MW-OU2-07-A will be resurveyed after construction.

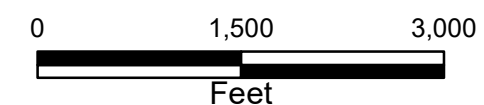
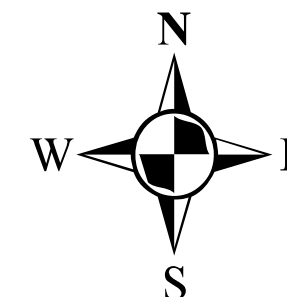

OU2 A-Aquifer
 Groundwater Monitoring Program
 Sample Locations
 Quality Assurance Project Plan
 Former Fort Ord, California
 Volume 1, Appendix A, Revision 9
 Groundwater Remedies and Monitoring at Operable Unit 2.



EXPLANATION

Well Type and Sample Schedule

- Extraction Well - Quarterly VOCs
- Monitoring Well - Quarterly VOCs
- Monitoring Well - Annual VOCs
- Extraction Well - Water Levels
- Monitoring Well - Water Levels

Groundwater Divide

- Approximate Location of the 180-Foot Ground Water Divide
- Fort Ord Landfills (Areas B - F)
- Roads

NOTE:
 *MW-OU2-84-180 has not been surveyed due to construction.

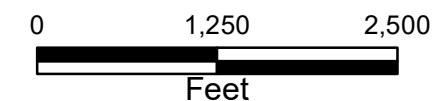
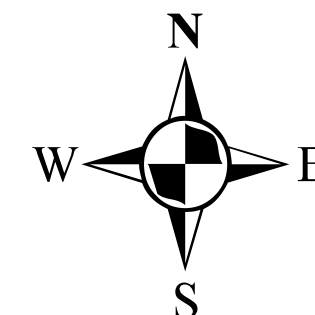



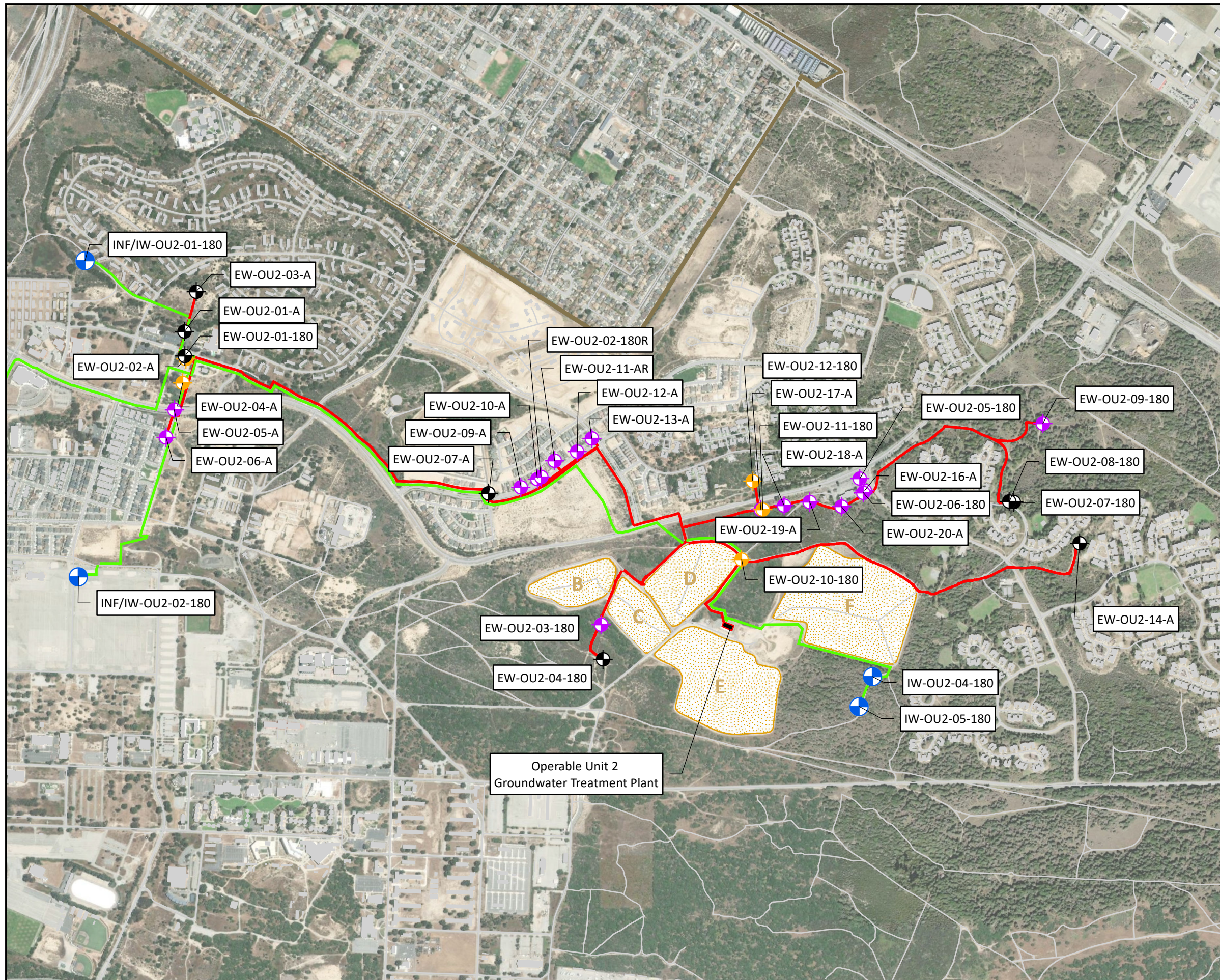

OU2 Upper 180-Foot Aquifer
 Groundwater Monitoring Program
 Sample Locations
 Quality Assurance Project Plan
 Former Fort Ord, California
 Volume 1, Appendix A, Revision 9
 Groundwater Remedies and Monitoring at Operable Unit 2,
 Sites 2 and 12, and Operable Unit Carbon Tetrachloride.









EXPLANATION

Well Type and Use

-  Extraction Well - Operated
-  Extraction Well - Not Operated
-  Extraction Well - Not Operated - No Pump
-  Injection Well - Operated

Groundwater Pipeline

-  Groundwater Extraction
-  OU2 Treated Water Discharge
-  Roads
-  Facilities
-  landfill_cell_area
-  Former Fort Ord Boundary

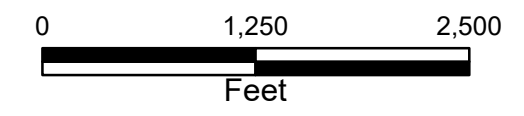
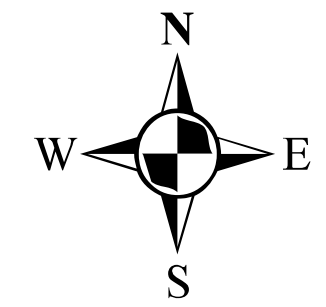

OU2 Groundwater Remedy and OUCTP Upper 180-Foot Aquifer Groundwater Remedy Map
 Quality Assurance Project Plan
 Former Fort Ord, California
 Volume 1, Appendix A, Revision 9
 Groundwater Remedies and Monitoring at Operable Unit 2, Sites 2 and 12, and Operable Unit Carbon Tetrachloride.

FILENAME: P:\Projects\JRGF JV0001R00RE JV GWTP Fort Ord\10.0_CADD\CADD\400_CADD\Figures\Fig 2-5.dwg

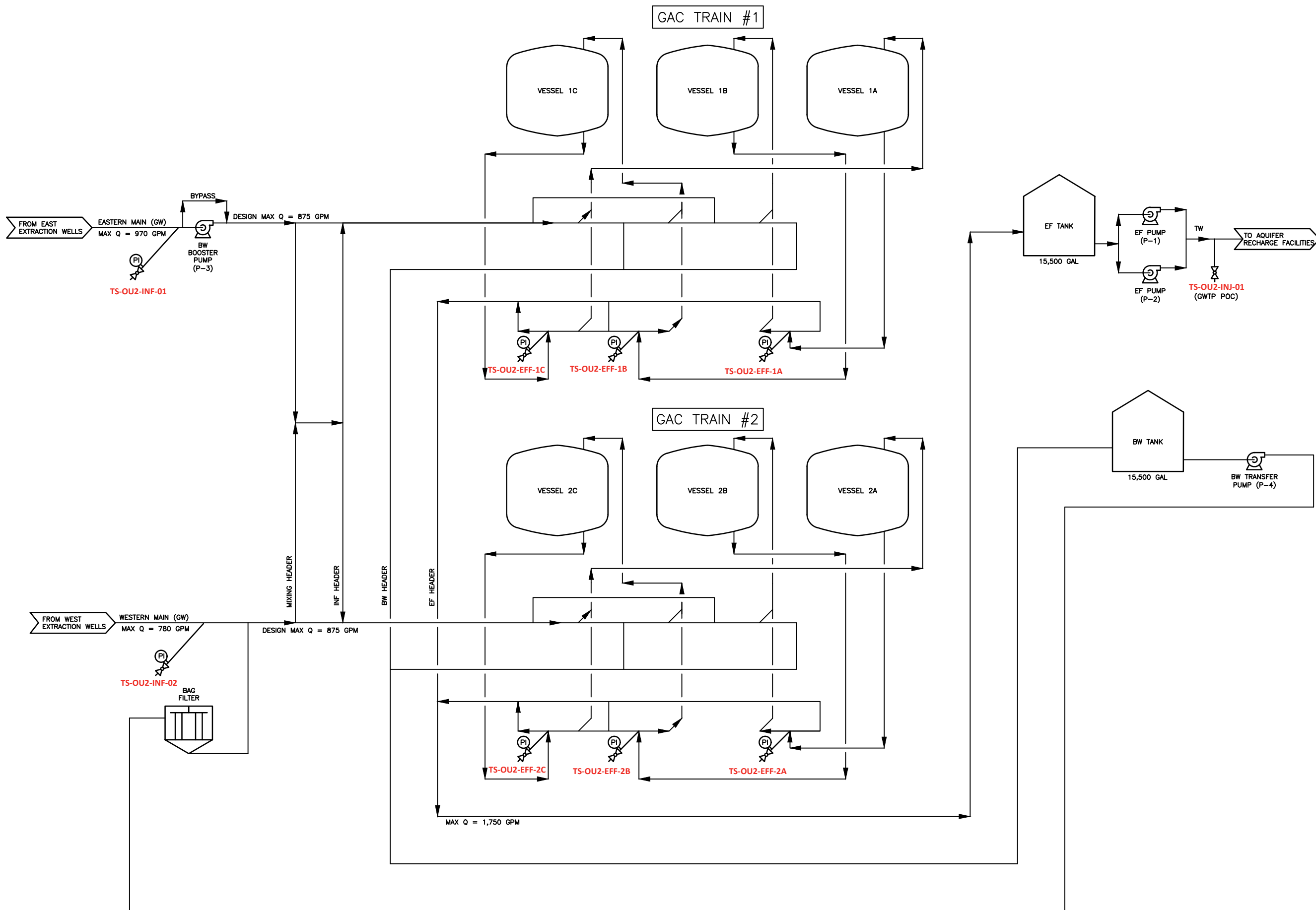

Legend

ABBREVIATIONS

BW	BACKWASH
EF	EFFLUENT
GAC	GRANULAR ACTIVATED C.
GAL	GALLONS
GPM	GALLONS PER MINUTE
GW	GROUNDWATER (UNTREA
GWTP	GROUNDWATER TREATME
MAX	MAXIMUM
PI	PRESSURE INDICATOR
POC	POINT OF COMPLIANCE
Q	FLOW RATE
SP	SAMPLE PORT
TW	TREATED WATER

- NOTES**
1. VALVES ARE NOT INDICATED.
 2. FLOW ARROWS INDICATE NORMAL OPERATION, WITH VESSEL SEQUENCE A-B-C IN EACH GAC TRAIN.

Locations in red font are sample locations

Note: The lead GAC vessel effluent will be sampled at the time of the sampling event

OU2 Groundwater Treatment Plant Schematic

Quality Assurance Project Plan
Former Fort Ord, California
Volume I, Appendix A Revision 9, Groundwater Remedies and Monitoring at Operable Unit 2, Sites 2 and 12, and Operable Unit Carbon Tetrachloride Plume



Figure
8

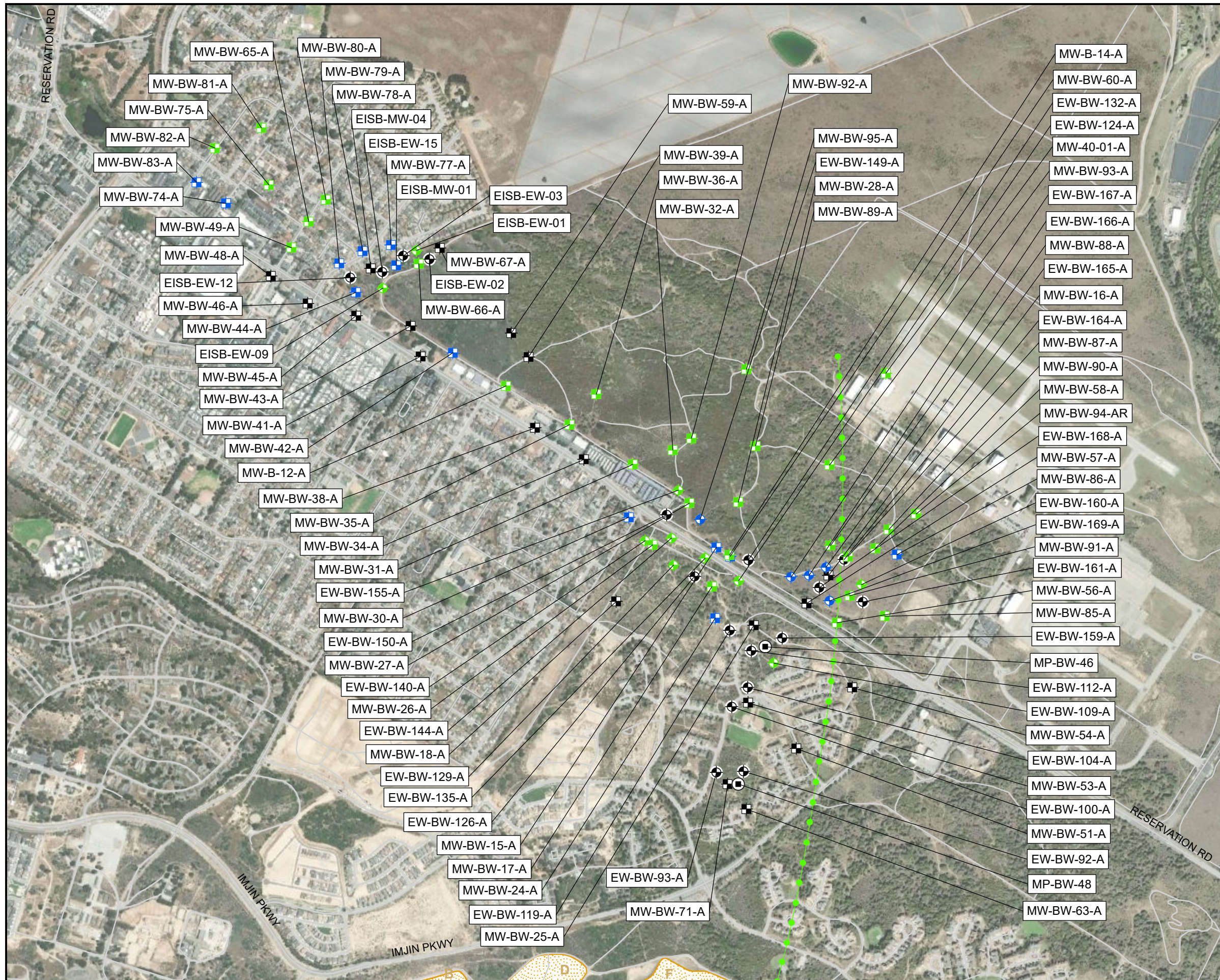

EXPLANATION

Well Type and Sample Schedule

- Monitoring Well - Water Levels
- Extraction Well - Quarterly VOCs
- Multi-Port Well - Quarterly VOCs
- Monitoring Well - Quarterly VOCs
- Extraction Well - Annual VOCs
- Multi-Port Well - Annual VOCs
- Monitoring Well - Annual VOCs
- Extraction Well - Water Levels
- Multi-Port Well - Water Levels

Groundwater Divide

- Approximate Location of the A-Aquifer Groundwater Divide
- Roads
- Fort Ord Landfills (Areas B -

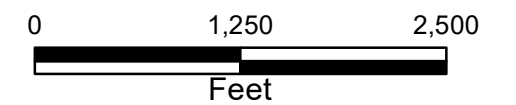
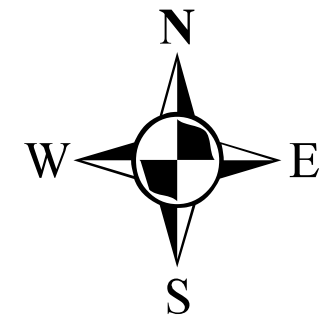

OUCTP A-Aquifer
Groundwater Monitoring Program
Sample Locations
 Quality Assurance Project Plan
 Former Fort Ord, California
 Volume 1, Appendix A, Revision 9
 Groundwater Remedies and Monitoring at Operable Unit 2,
 Sites 2 and 12, and Operable Unit Carbon Tetrachloride.

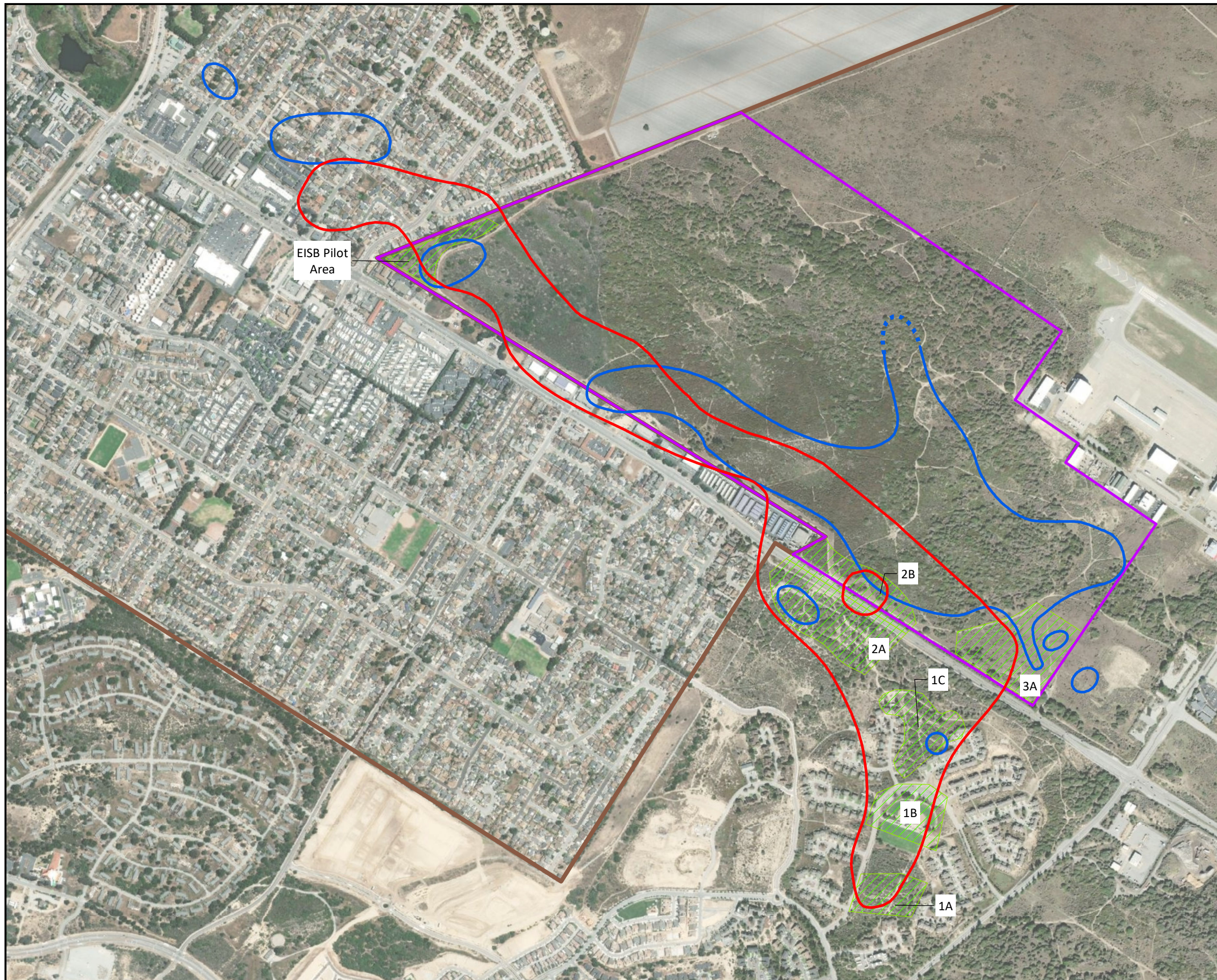

EXPLANATION

- ACL Exceedance 2008-4Q**
- CT (0.5 µg/L)
- ACL Exceedance 2020-3Q**
- CT (0.5 µg/L)
- Estimated CT (0.5 µg/L)
- ▨ Enhanced In-Situ Bioremediation (EISB) Deployment Areas
- ▭ Fort Ord Natural Reserve
- ▭ Former Fort Ord Boundary

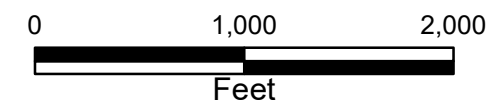
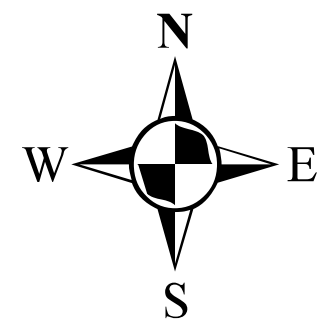

OUCTP A-Aquifer
 EISB Groundwater Remedy
 Deployment Areas
 Quality Assurance Project Plan
 Former Fort Ord, California
 Volume 1, Appendix A, Revision 9
 Groundwater Remedies and Monitoring at Operable Unit 2,
 Sites 2 and 12, and Operable Unit Carbon Tetrachloride.



EXPLANATION

Well Type and Sampling Schedule

- Extraction Well - Quarterly VOCs
- Multi-Port Well - Quarterly VOCs
- Monitoring Well - Quarterly VOCs
- Multi-Port Well - Annual VOCs
- Monitoring Well - Annual VOCs
- Extraction Well - Water Levels
- Multi-Port Well - Water Levels
- Monitoring Well - Water Levels
- Roads
- Fort Ord Landfills (Areas B - F)

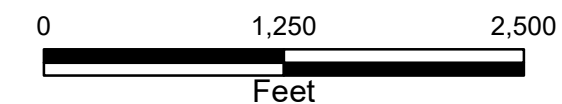
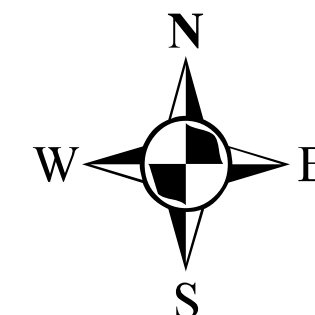

OUCTP Upper 180 - Foot Aquifer
 Groundwater Monitoring Program
 Sample Locations
 Quality Assurance Project Plan
 Former Fort Ord, California
 Volume 1, Appendix A, Revision 9
 Groundwater Remedies and Monitoring at Operable Unit 2,
 Sites 2 and 12, and Operable Unit Carbon Tetrachloride.

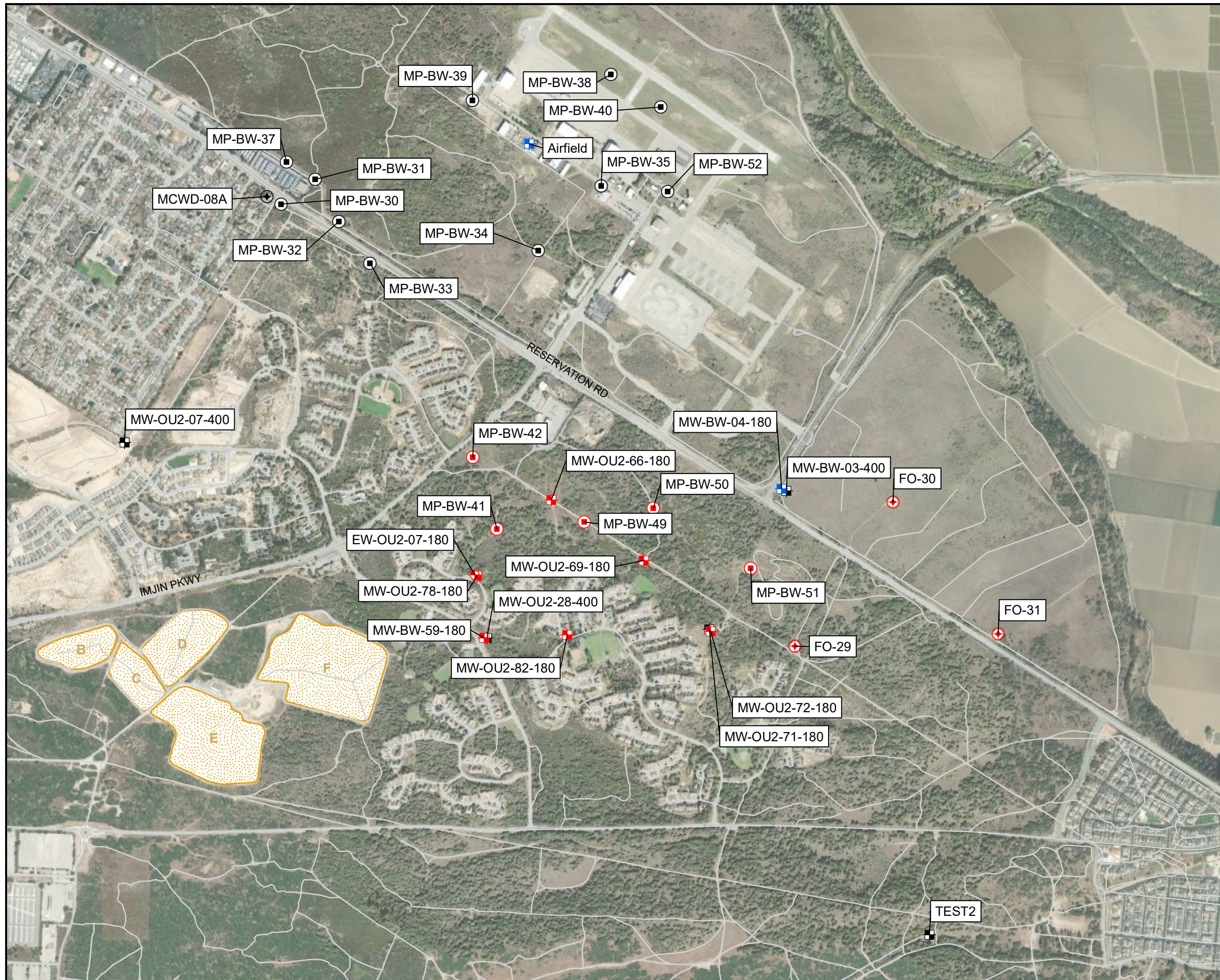

EXPLANATION

Well Type and Sample Schedule

- Extraction Well - Quarterly VOCs and Water Level
- MCWD Production Wells - Quarterly VOCs
- Multi-Port Well - Quarterly VOCs and Water Level
- Monitoring Well - Quarterly VOCs and Water Level
- Monitoring Well - Annual VOCs and Quarterly Water Level
- MCWD Well - Quarterly Water Level
- Multi-Port Well - Quarterly Water Level
- Monitoring Well - Quarterly Water Level
- Fort Ord Landfills (Areas B - F)
- Roads

NOTE:
 *MW-OU2-07-400 will be resurveyed after construction.

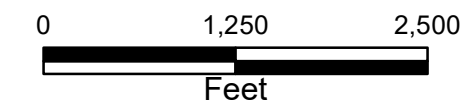
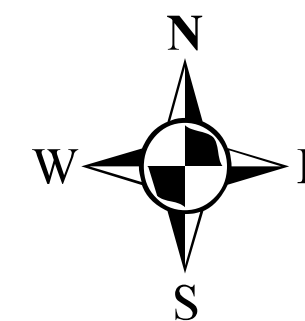

OUCTP Lower 180-Foot Aquifer
 Groundwater Monitoring Program
 Sample Locations
 Quality Assurance Project Plan
 Former Fort Ord, California
 Volume 1, Appendix A, Revision 9
 Groundwater Remedies and Monitoring at Operable Unit 2,
 Sites 2 and 12, and Operable Unit Carbon Tetrachloride.

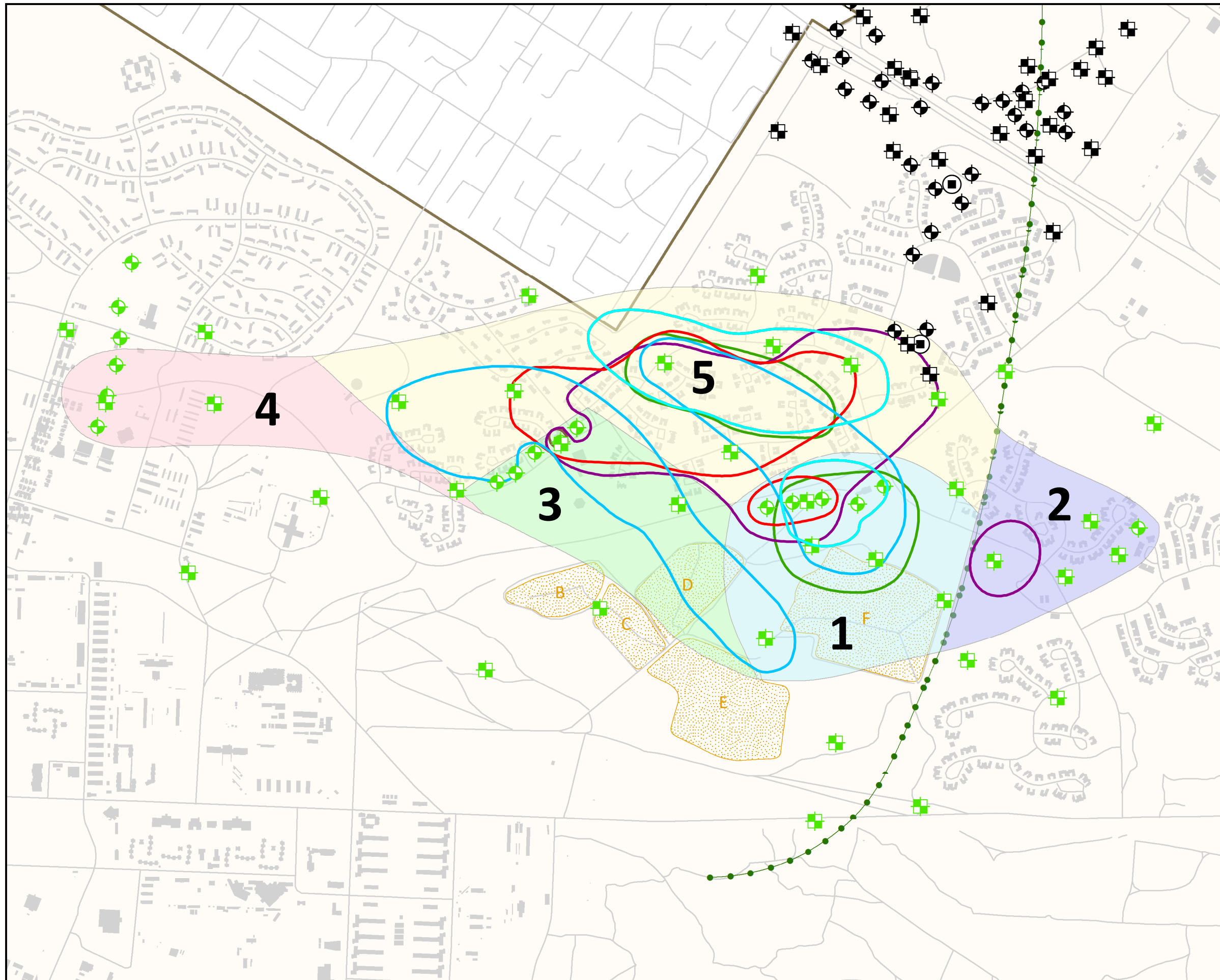

EXPLANATION

- Approximate location of the A-Aquifer Groundwater Divide
- Roads
- OU2 Landfill
- Facilities
- Former Fort Ord Boundary
- Well Type and Site**
- ⊕ OU2-A Extraction Well
- ⊞ OU2-A Monitoring Well
- ⊕ OUCTP-A Extraction Well
- ⊞ OUCTP-A Monitoring Well
- ⊗ OUCTP-A Multi-Port Well
- 2020-3Q Chemical of Concern (COC) Aquifer Cleanup Level (ACL) Exceedance Contour in µg/L**
- Trichloroethene (TCE) (5 µg/L)
- Tetrachloroethene (PCE) (3 µg/L)
- 1,1-Dichloroethane (1,1-DCA) (5 µg/L)
- 1,2-Dichloroethane (1,2-DCA) (0.5 µg/L)
- Vinyl Chloride (VC) (0.1 µg/L)
- Hydraulic Zones 1-5**
- ⊞ 1
- ⊞ 2
- ⊞ 3
- ⊞ 4
- ⊞ 5

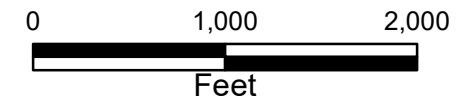
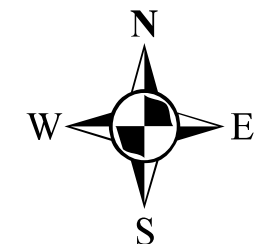

OU2 A-Aquifer Hydraulic Zone Map

Quality Assurance Project Plan
 Former Fort Ord, California
 Volume 1, Appendix A, Revision 9
 Groundwater Remedies and Monitoring at Operable Unit 2,
 Sites 2 and 12, and Operable Unit Carbon Tetrachloride.



April 9, 2021

Figure: **13**

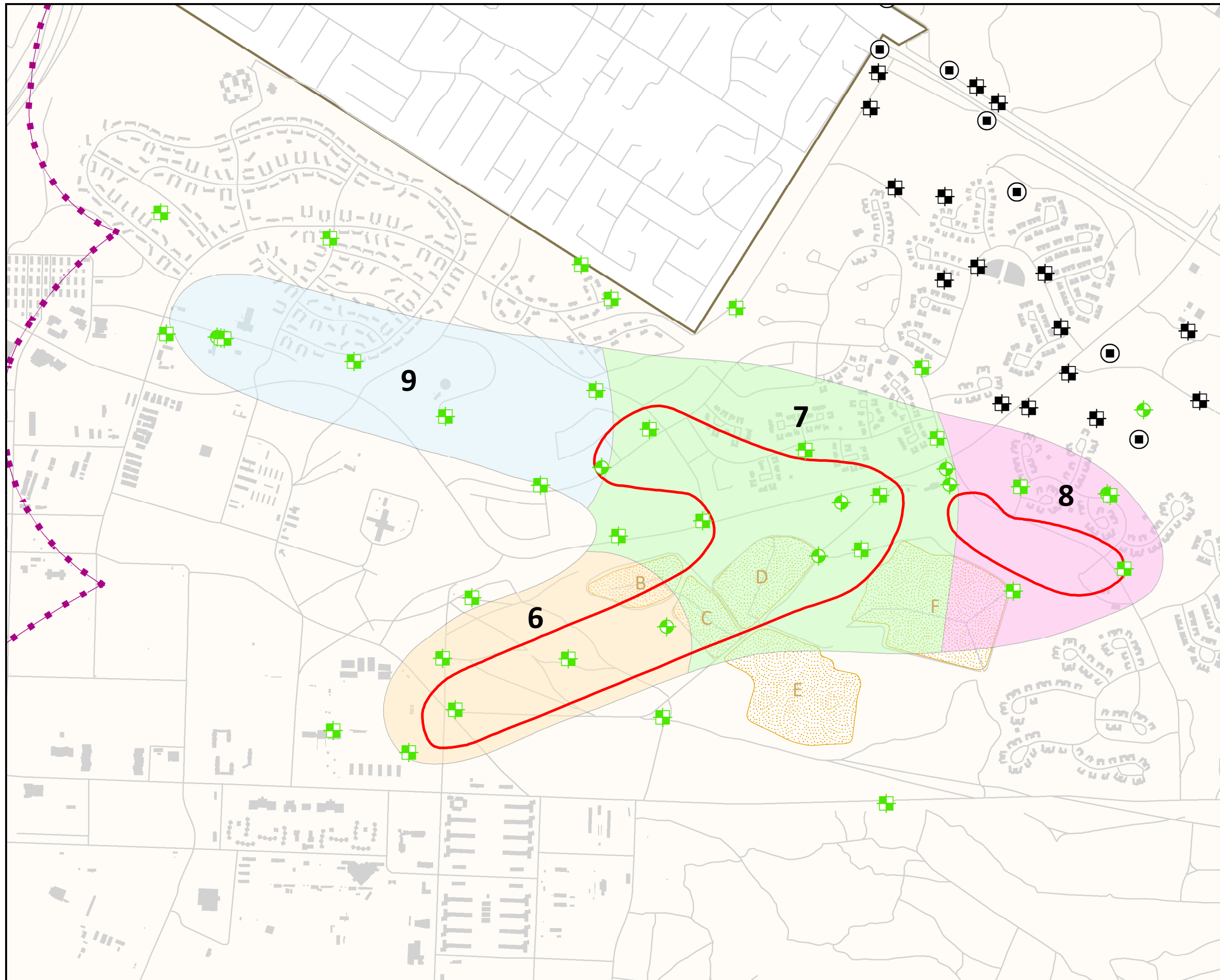

EXPLANATION

- Approximate location of the Upper 180-Foot Aquifer Groundwater Divide
- Roads
- Facilities
- Approximate Extent of Landfill Areas (Areas B through F)
- Former Fort Ord Boundary
- Well Type and Site**
- OU2 Upper 180-Foot Extraction Well
- OU2 Upper 180-Foot Monitoring Well
- OUCTP Upper 180-Foot Multi-Port Well
- OUCTP Upper 180-Foot Monitoring Well
- 2020-3Q Chemical of Concern (COC) Aquifer Cleanup Level (ACL) Exceedance Contour in µg/L**
- Trichloroethene (TCE) (5 µg/L)
- Hydraulic Zones 6-9**
- 6
- 7
- 8
- 9

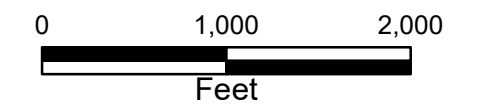
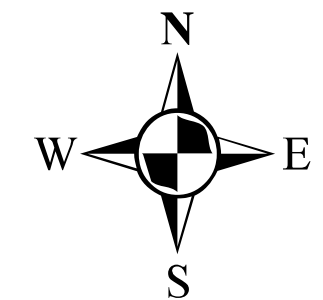

OU2 Upper 180-Foot Aquifer
Hydraulic Zone Map

Quality Assurance Project Plan
Former Fort Ord, California
Volume 1, Appendix A, Revision 9
Groundwater Remedies and Monitoring at Operable Unit 2,
Sites 2 and 12, and Operable Unit Carbon Tetrachloride.

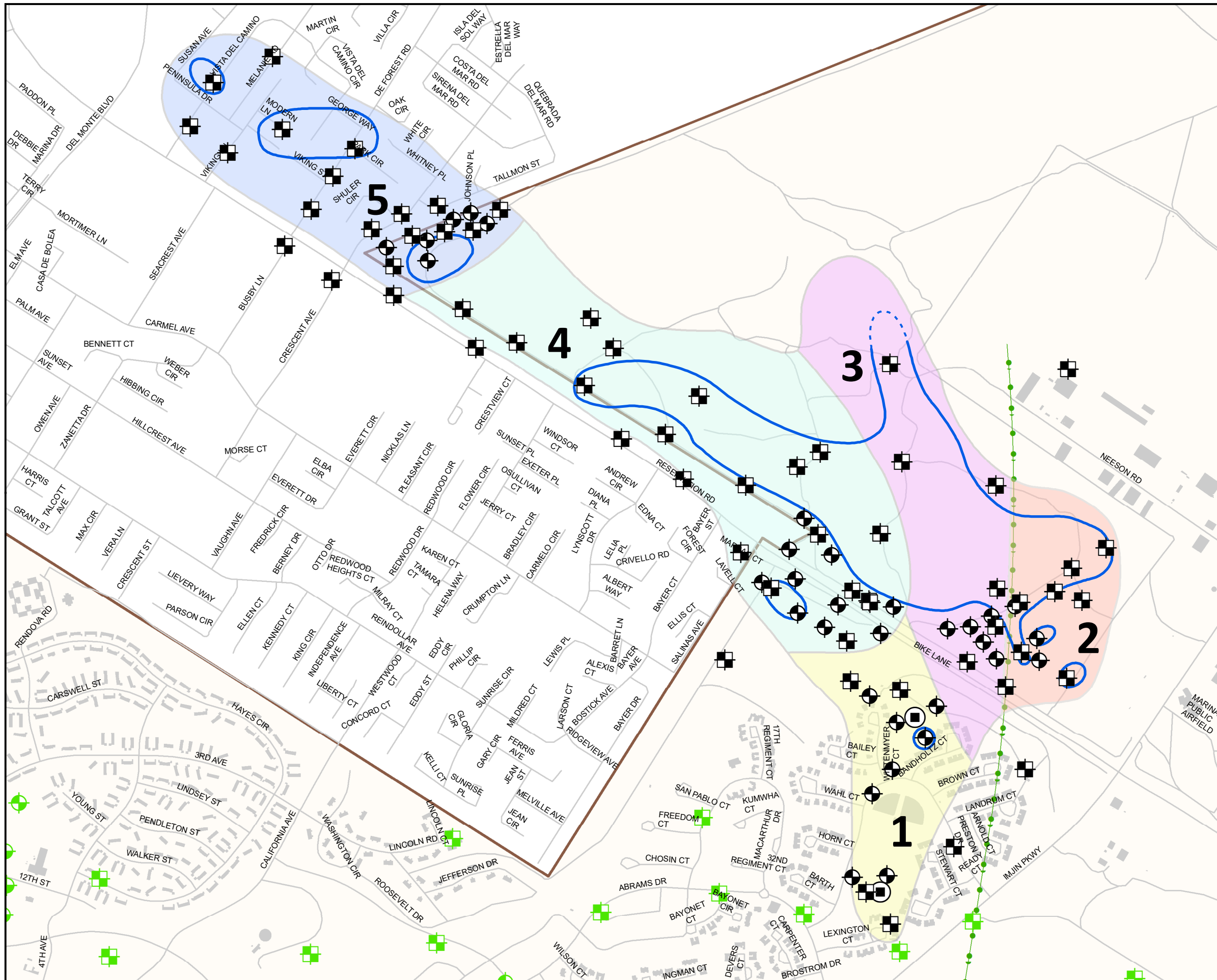

EXPLANATION

- Approximate Location of the A-Aquifer Groundwater Divide
- Facilities
- Roads
- Former Fort Ord Boundary
- Well Type and Site**
- OU2-A Extraction Well
- OU2-A Monitoring Well
- OUCTP-A Extraction Well
- OUCTP-A Monitoring Well
- OUCTP-A Multi-Port Well
- ACL Exceedance 2020-3Q**
- CT (0.5 µg/L)
- Estimated CT (0.5 µg/L)
- OUCTP-A Hydraulic Zones 1-5**
- 1
- 2
- 3
- 4
- 5

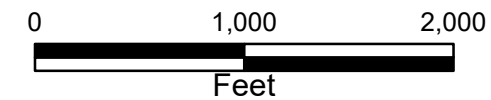
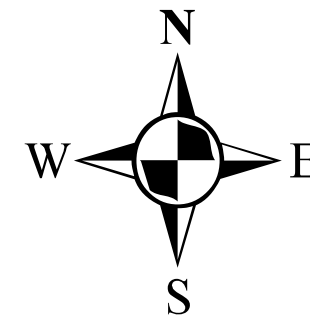

OUCTP A-Aquifer Hydraulic Zone Map

Quality Assurance Project Plan
 Former Fort Ord, California
 Volume 1, Appendix A, Revision 9
 Groundwater Remedies and Monitoring at Operable Unit 2,
 Sites 2 and 12, and Operable Unit Carbon Tetrachloride.



May 24, 2021

Figure: **15**

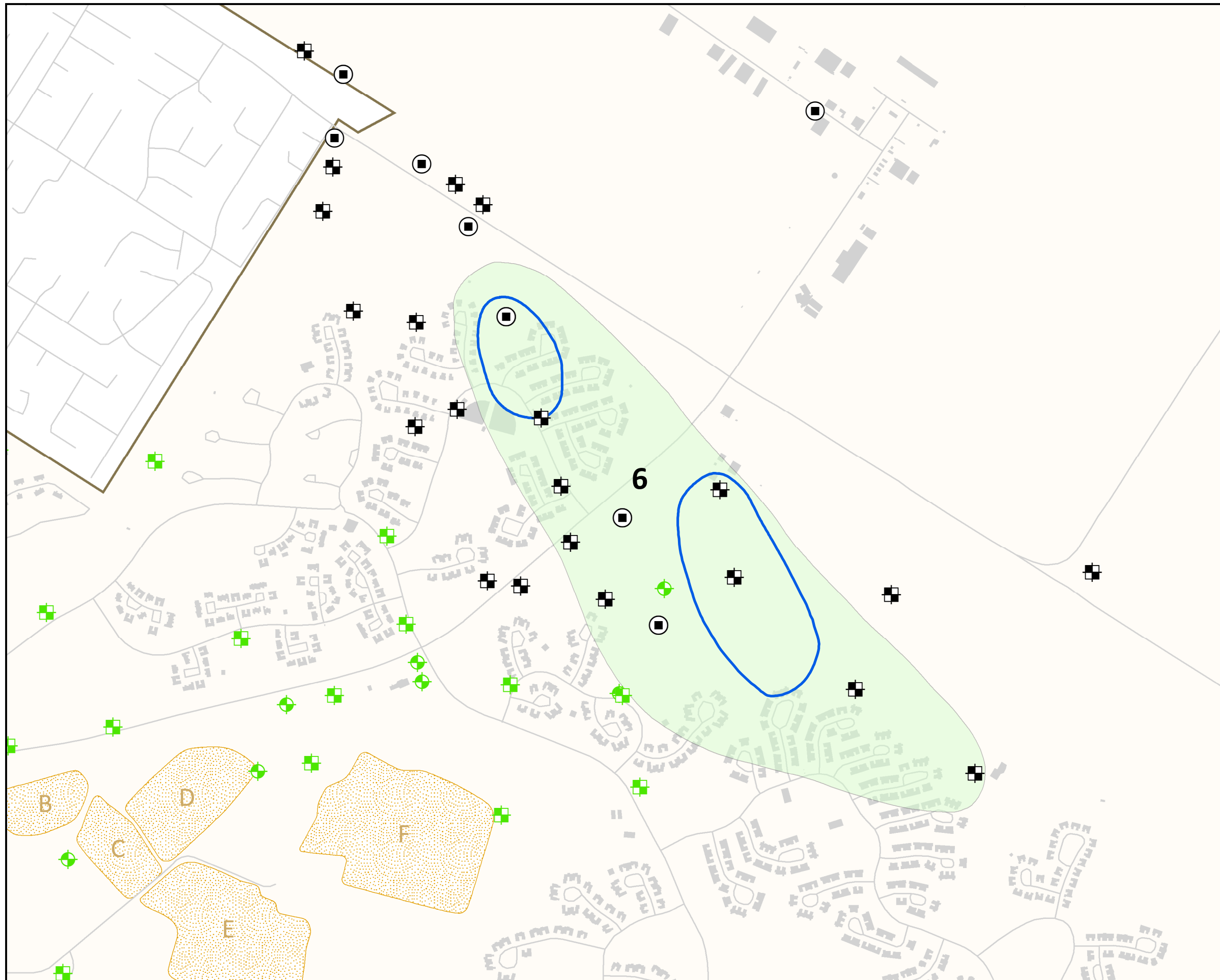

EXPLANATION

- Roads
- Facilities
- ▨ Approximate Extent of Landfill Areas (Areas B through F)
- ▭ Former Fort Ord Boundary
- Well Type and Site**
- ⊕ OU2 Upper 180-Foot Extraction Well
- ⊞ OU2 Upper 180-Foot Monitoring Well
- ⊙ OUCTP Upper 180-Foot Multi-Port Well
- ⊞ OUCTP Upper 180-Foot Monitoring Well
- 2020-3Q Chemical of Concern (COC) Aquifer Cleanup Level (ACL) Exceedance Contour in µg/L**
- Carbon Tetrachloride (CT) (0.5 µg/L)
- Hydraulic Zone**
- 6

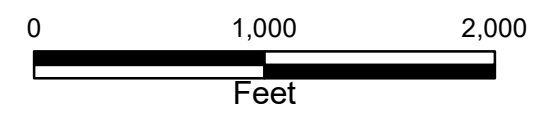
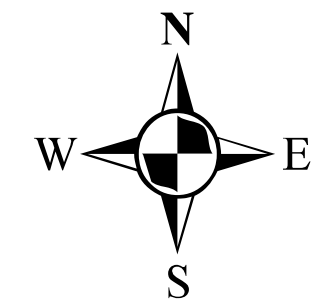

OUCTP Upper 180-Foot Aquifer Hydraulic Zone Map

Quality Assurance Project Plan
 Former Fort Ord, California
 Volume 1, Appendix A, Revision 9
 Groundwater Remedies and Monitoring at Operable Unit 2,
 Sites 2 and 12, and Operable Unit Carbon Tetrachloride.

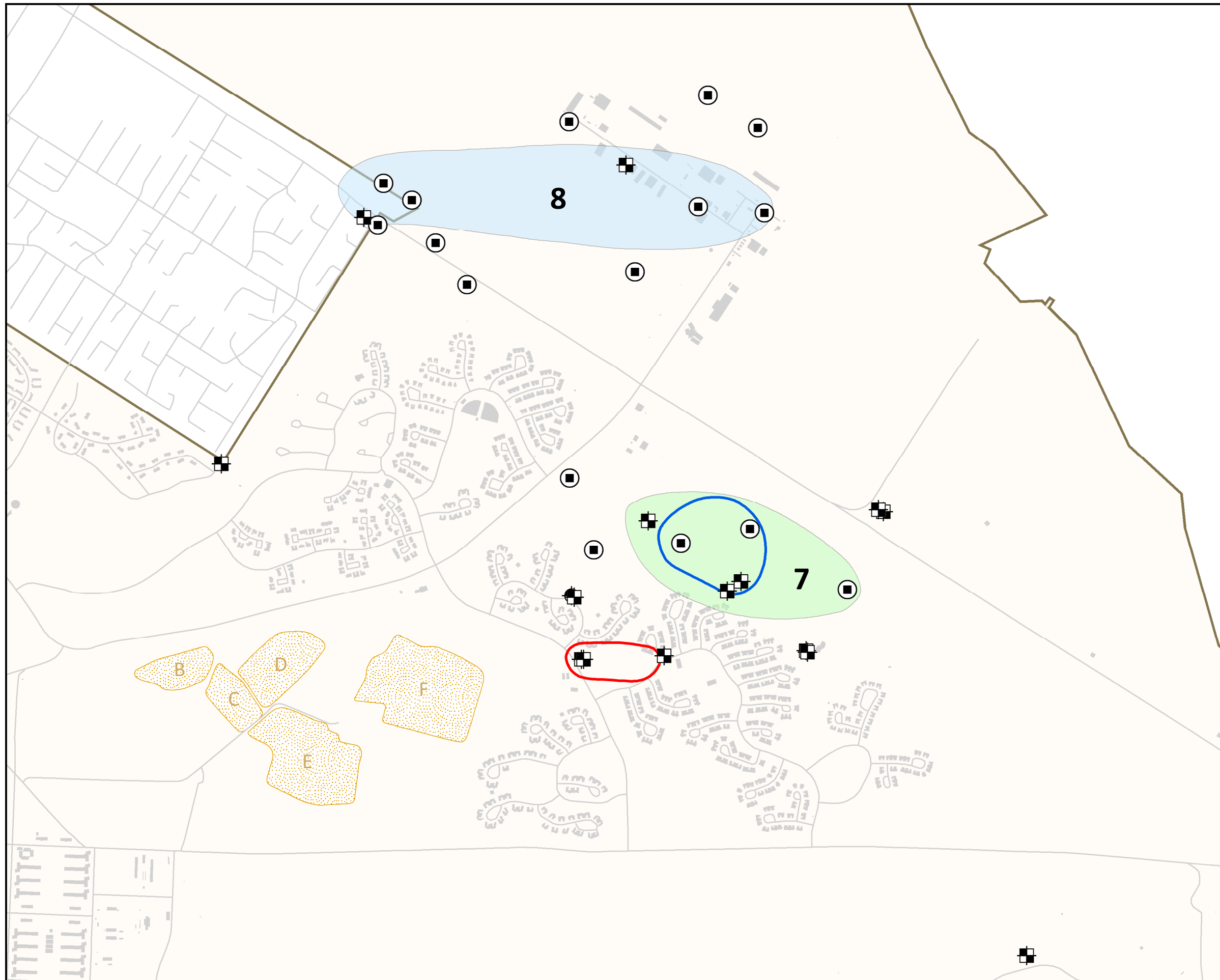

EXPLANATION

- Roads
- Facilities
- ▨ Approximate Extent of Landfill Areas (Areas B through F)
- ▭ Former Fort Ord Boundary

Well Type and Site

- ⊕ OUCTP Lower 180-Foot Extraction Well
- ⊞ OUCTP Lower 180-Foot Monitoring Well
- ⊙ OUCTP Lower 180-Foot Multi-Port Well

2020-3Q Chemical of Concern (COC) Aquifer Cleanup Level (ACL) Exceedance Contour in µg/L

- Carbon Tetrachloride (CT) (0.5 µg/L)
- Trichloroethene (TCE) (5 µg/L)

Hydraulic Zones 7 & 8

- 7
- 8

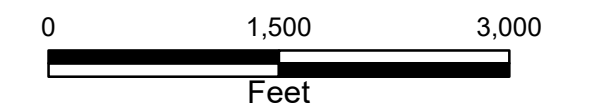
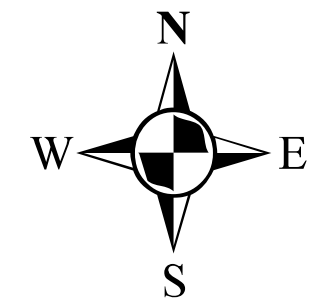

OUCTP Lower 180-Foot Aquifer Hydraulic Zone Map

Quality Assurance Project Plan
 Former Fort Ord, California
 Volume 1, Appendix A, Revision 9
 Groundwater Remedies and Monitoring at Operable Unit 2,
 Sites 2 and 12, and Operable Unit Carbon Tetrachloride.

TABLE

Table 1: Summary of Existing Monitoring Wells and Samples Collected Annually

Site	Aquifer	Total Number ¹ of Wells Per Aquifer	Number of Army-Owned Wells	Total Number of Sample Ports Currently Sampled	Number of Well/Ports Sampled Quarterly	Number of Wells/Ports Sampled Annually	Number of Wells Not Sampled (water level only)	Number of Samples Collected Annually ²	Average Well Depth ³ (feet)
Sites 2 and 12	A	0	0	0	0	0	0	0	NA
	Upper 180	37	37	18	16	2	19	73	107
	Lower 180	1	1	0	0	0	1	0	179
Subtotal		38	38	18	16	2	20	73	NA
Operable Unit 2	A	58	58	41	40	1	17	177	134
	Upper 180	43	43	30	28	2	13	125	222
	Lower 180	0	0	0	0	0	0	0	NA
Subtotal		101	101	71	68	3	30	302	NA
Operable Unit Carbon Tetrachloride Plume	A	98	98	58	42	16	40	202	101
	Upper 180	38	38	12	9	3	26	43	271
	Lower 180 ⁴	93	89	22	20	2	71	90	433
Subtotal		229	225	92	71	21	137	335	NA
Total Number of Samples Collected Annually									710

Notes:

¹ Number of wells in the groundwater monitoring program (not including wells not measured for depth to water and to be decommissioned at a later date).

² Includes duplicate samples collected during groundwater monitoring at a frequency of 10 percent (%) per quarterly event.

³ Value provided is the average depth for the wells that are sampled at the site/aquifer specified. For multipoint wells, one value was used - the deepest port sampled

⁴ The total number of wells includes four wells owned by Marina Coast Water District: MCWD-08A, FO-29, FO-30, and FO-31.

ATTACHMENTS

ATTACHMENT A

Standard Operating Procedures (SOPs)

Sampling SOPs

1. Westbay MOSDAX Sampler Probe – Model 2531 Operations Manual
2. Passive Diffusion Bag (PDB) Sampling Protocol
3. HydraSleeve Field Manual
4. Supply and Irrigation Well Sampling Protocol
5. OU2 and Sites 2/12 GWTSs and OUCTP EISB Extraction Well Sample Handling and Custody Requirements
6. Low Flow Groundwater Quality Parameter Collection
7. Downhole Meter Groundwater Quality Parameter Collection

OPERATIONS MANUAL

Westbay MOSDAX Sampler Probe - Model 2531



NOTICE

Operation of Westbay System equipment should only be undertaken by qualified instrument technicians who have been trained by Westbay authorized personnel.

This document contains proprietary information. No part of this document may be photocopied, reproduced or translated to another language without the prior written consent of Westbay Instruments Inc. The information contained in this document is subject to change without notice.

DO NOT OPEN THE SAMPLER

All warranties expressed or implied will be void if, after examination by Westbay Instruments Inc. personnel, it is established that any of the instrument housings have been opened without prior authorization from Westbay Instruments Inc.

DO NOT LET THE SAMPLER FREEZE

Extreme care should be taken to avoid freezing the MOSDAX Sampler probe. Permanent transducer damage may result from freezing.

Manual Revision: 1.13 20 October 2006

Issued for Serial No.: _____

Date: _____

Signature: _____

Contents

1. DESCRIPTION	1
1.1 MOSDAX Sampler Probe, Model 2531	1
1.2 MOSDAX Automated Groundwater Interface (MAGI), Model 2536	1
1.3 Cable Reels	1
1.4 Sample Containers	1
2. PRESSURE PROFILING	2
2.1 Items Required	2
2.2 Surface Checks	2
2.3 Pressure Measurement Procedures	3
3. FLUID SAMPLING	4
3.1 Items Required	4
3.2 Surface Checks and Preparation	4
3.3 Drillhole Sampling	5
3.4 Rinsing Instructions	5
4. CARE AND MAINTENANCE	6
4.1 MPCI	6
4.2 Cable Reels and Control Cable	6
4.3 MOSDAX Sampler Probe	6
4.3.1 Face Seal	6
4.3.2 Location Arm	6
4.3.3 Button Shoe Replacement	7
4.3.4 Actuator Nut	7
5. CALIBRATION	7
6. SPARE PARTS LIST	8

1. DESCRIPTION

1.1 MOSDAX Sampler Probe, Model 2531

The MOSDAX Sampler is a downhole probe designed to collect fluid pressure information and fluid samples from Westbay System monitoring wells. Each MOSDAX pressure sensor is calibrated over its full pressure range for nonlinearity and temperature variation. MOSDAX Sampler probes are available in a variety of pressure ranges to permit operation to various depths. The shoe and valve motors can be operated from the surface. The power for the shoe and valve motors is supplied from the surface.

1.2 MOSDAX Automated Groundwater Interface (MAGI), Model 2536

The MOSDAX Sampler can be operated directly by the keypad on the MOSDAX Automated Groundwater Interface (MAGI), or by a Hand Held Controller (HHC) connected to the MAGI, or with a computer running Microsoft Windows (2000 or higher) and Westbay software connected to the MAGI. The MAGI translates the signals between the computer or HHC and the MOSDAX Sampler. The MAGI requires 12 volt DC power to operate.

Older versions of MOSDAX sampling equipment may incorporate a Model 2522 MOSDAX PC Interface (MPCI) and HHC rather than a MAGI. For such systems, reference to the MAGI in this document can be considered as reference to the MPCI and HHC.

1.3 Cable Reels

The manual cable reel can operate all Westbay probes and tools to a depth of 300m (1,000 ft) on a single-conductor cable. The manual reel is hand operated with an internal brake to control the speed of descent of the probe in the well. The two-pin cable connects the MAGI to the reel and the signals pass through a slipring located in the hub of the reel into the control cable. For maintenance information, see the appropriate cable reel manual.

Motorized cable reels are available for deeper applications.

1.4 Sample Containers

Sample containers can be used with the MOSDAX Sampler. The nonvented stainless steel sample containers maintain samples under formation pressure while the sampler and container are brought to the surface.

2. PRESSURE PROFILING

2.1 Items Required

- MOSDAX Sampler Probe, Model 2531
- MAGI, Model 2536 with:
 - one two-pin data cable
 - one three-pin power cable
 - hand held controller with cable and user's guide (optional)
 - computer running Windows 2000 or higher with one nine-pin computer cable and MProfile software (optional)
- MOSDAX-compatible winch with cable
- Sheave with counter and tripod
- 12 VDC, 2 Amp power source (Battery pack, car/truck battery, or transformer)
- Water level measuring tape
- MProfile User's Guide for computer or the Handheld Controller Operations Manual
- Westbay Casing Log showing depths to ports and couplings in hole to be tested.

2.2 Surface Checks

1. Remove the MOSDAX Sampler from its storage case. Inspect the probe housing and body for any damage. Please contact Westbay for advice on any cover tube damage.
2. Assemble the tripod and counter over the well. Run the cable over the counter.
3. Connect the probe to the cable. Before attaching, inspect the O-ring at the top of the probe and lubricate with silicon. The O-ring should be clean and intact. Tighten the nut hand tight only.
4. Connect the two-pin cable from the MPC1 to the cable reel. With the MPC1 OFF connect the three-pin cable from the MPC1 to the 12 v power supply.
5. Connect the 9 pin cable from computer or HHC to the MPC1 and turn the MPC1 ON.
6. Perform the following surface checks to ensure that the location arm and the shoe mechanisms are operating normally: Release the location arm. The location arm should extend smoothly. The number of revolutions used to release the location arm is displayed and should be 15 to 16 revolutions. If a smaller number of revolutions is reported, retract the arm and repeat. Place the probe in a piece of Westbay casing or coupling. Activate the shoe. The shoe should extend and hold the probe firmly in the coupling or casing. The display should indicate 16 to 19 revolutions. A reading of 23 revolutions indicates the probe is activated in open air. Retract the backing shoe.

7. Check that the face plate for sampling and the plastic plunger are installed on the sampler.
8. The probe is now ready to be lowered down the well.

2.3 Pressure Measurement Procedures

1. Obtain the completed Westbay Casing Log.
2. With the location arm retracted, lower the probe into the Westbay casing to immediately below the lowest measurement port coupling to be monitored. If magnetic collars have been installed on the well, the Collar Detect Command can be used to detect the collars. The Collar Detect Command is cancelled by pressing any key.
3. Release the location arm. The display should update and beep after the arm is released.
4. Raise the probe about 0.5 m (1.5 ft) above this measurement port. If the probe is accidentally lifted above the next higher coupling, it will be necessary to retract the location arm and lower the probe to below the measurement port and release the arm.
5. Lower the probe gently until the location arm rests in the measurement port.
6. Record the pressure and temperature inside the Westbay casing.
7. Optional: If a water level tape is available, measure and record the depth to water in the Westbay casing.
8. Activate the shoe. The pressure on the display should change to the formation pressure.
9. When the reading has stabilized, record the formation pressure.
10. Once the pressure has been recorded, retract the shoe.
11. Record the pressure of the fluid in the Westbay casing. This reading should be similar to that recorded in Step 6. If a large difference is noted between the readings, record the water level inside the Westbay casing again using the water level tape.
12. The three pressure readings plus the time and water level constitute a complete set of readings at a measurement port coupling.
13. Continue up the Westbay casing to obtain the pressure data from other measurement ports.
14. Take one last set of pressure and temperature readings at the surface. These readings should be similar to those recorded in Step 2.

CAUTION: If a water level tape was used, remove the water level tape from the Westbay casing before removing the sampler probe from the well to prevent them from becoming jammed.

3. FLUID SAMPLING

3.1 Items Required

- MOSDAX Sampler, Model 2531
- MAGI, Model 2536 with:
 - one two-pin data cable
 - one three-pin power cable
 - hand held controller with cable and user's guide (optional)
 - computer running Windows 2000 or higher with one nine-pin computer cable and MProfile software (optional)
- MOSDAX-compatible winch with cable
- Sample containers and connecting tubes
- Westbay Casing Log
- Groundwater Sampling Field Data Sheet
- 12 VDC, 2 amp power source (battery pack, car/truck, or transformer)
- Counter and tripod
- Westbay Sampling Kit including vacuum pump

3.2 Surface Checks and Preparation

1. Set up the MOSDAX Sampler probe following Steps 1 through 8 of Section 2.2.
2. Attach the sample containers.
3. Release the location arm. Locate the probe in the vacuum coupling.
4. Activate the shoe in the vacuum coupling.
5. Close the sampler valve. The motor should run about 5 seconds. The display should indicate one revolution.
6. Use the vacuum pump to apply a vacuum through the vacuum coupling. The vacuum should remain constant. If the vacuum is not maintained, inspect for leaks at the face seal of the probe, the connection to the pump and at the probe sampling valve.
7. Once a vacuum has been maintained, open the sampler valve. Apply a vacuum again to check that all connections are sealed.
8. Close the sampler valve. A vacuum has now been applied to the sample bottles.
9. Retract the shoe.

3.3 Drillhole Sampling

1. Check recent pressure logs of the hole and ensure that the head inside the Westbay casing is lower than the head outside the measurement port to be sampled.
2. After completing the surface checks, follow Steps 1 to 5 of Section 2.3 to locate the sampler at the measurement port in the monitoring zone to be sampled.
3. Record the pressure reading.
4. Activate the probe and record the formation pressure.
5. Open the sampler valve. The pressure should drop and then slowly increase as the bottles fill. When the pressure in the bottle equals the zone pressure from Step 4, the bottle is full. Wait a maximum of two minutes per sample bottle even if the pressures are not equal.
6. Close the sampler valve and retract the shoe.
7. Record the pressure reading. A reading the same as in Step 3 indicates that the sample is OK.
8. Reel the sampler to the surface and remove it from the Westbay casing.
9. **Do not open the sampler valve as damage to the probe or injury to the operator could occur.**
10. Remove the cap from the bottom sample bottle and open the valve on the bottle to release the pressure and to transfer the sample.
11. Open the sampler valve to allow the sample to flow from the bottles. Once the pressure in the sampler and bottles has decreased to atmospheric, the bottles may be disconnected to speed the process.
12. Take particular care in handling pressurized samples.

3.4 Rinsing Instructions

Rinse the sampler around the face seal and the bottom connector. With the sampler valve open, flush the interior of the sampler from the bottom connector. Rinse the sample bottles and connectors.

Note: Project specific procedures for decontaminating the sampler and sample bottles are the responsibility of the project manager and are not covered in this manual.

4. Care and Maintenance

The MOSDAX Sampler System must be routinely maintained for optimum performance. The procedures outlined here are required to keep the instrument operating properly. For any additional information or advice, please contact Westbay Instruments Inc.

4.1 MAGI

The MAGI should be cleaned to remove dirt and dust and inspected for damage or wear. If any part requires replacement, contact Westbay for information.

4.2 Cable Reels and Control Cable

The cable reels should be kept clean and protected from damage. The cable and cable head should be inspected for kinks and corrosion. Rehead the cable if necessary. For more information concerning cable reels and the control cable, refer to the appropriate reel manual.

4.3 MOSDAX Sampler Probe

1. Never allow the probe to freeze or the pressure transducer may be damaged.
2. Clean and inspect the probe for dents and scratches on the cover tube. Clean the threads with a nylon brush, such as a toothbrush. DO NOT use a wire brush. Protect the O-rings from damage and dirt.

4.3.1 Face Seal

Inspect the face seal and replace if damaged or worn.

1. Remove the two screws holding the face plate to the probe body and lift the face plate off.
2. Remove the face seal and plunger. Set the location arm assembly aside. Clean the plunger and probe body.
3. When reinstalling the face plate hold the face seal, plunger and location arm assembly in place. Replace the two screws the hold the face plate on the probe.

4.3.2 Location Arm

Release the location arm. Check that the arm moves smoothly and freely and check for damage and sharp edges due to wear. Replace the location arm if necessary.

1. Release the location arm. Remove the two screws and face plate (Section 4.3.1).
2. Remove the location arm with its spring and pivot pin. Clean and inspect all parts and replace if needed.
3. Insert the spring and pivot in the location arm and place the assembly in the probe body. Place the face plate over the face seal and location arm and tighten the two screws.

SECTION 4.3.2 SUPPLEMENT

WESTBAY Probe Location Arm replacement

- a) It is easier when the arm is first extended to the "out" position (Fig. A). Do this before powering down and disconnecting the probe.
- b) Remove the face seal slowly and stabilize the arm as it is under tension from the spring (Section 4.3.2.2) and may suddenly pop out. Observe the position and orientation of the parts as they are removed (Fig. B).
- c) Insert the hook of bent leg of the spring into the tiny hole on the neck of the new arm and align the spring coil opening alongside the larger hole in the arm with the spring leg positioned directly against the arm and over the pivot facing out (Fig. C-1). The metal pivot pin goes through the hole in the arm and through the spring coil (Fig. C-2). The straight leg of the spring leads under the pivot into the smaller side slot on the side of the main arm aperture, parallel with the probe. Place the assembly into its space in the probe body (Fig. C-3). The arm assembly has to be held in place while replacing the face seal to counter the force of the slightly compacted spring (Fig.C-4).
- d) Replace the face seal by sliding it toward the top of the probe and sliding the top edge into the slot while at the same time allowing the arm to protrude through the face seal. The arm should remain in the extended position while screwing down the face seal.
- e) Check to see that the arm can be freely, manually pushed in and that it pops back out when released. Attach the probe to the cable and mechanically retract the arm using the MAGI commands.

Figure A - Arm is extended out at start of replacement operation.



Figure B - Disassembled face seal and location arm.



Figure C-1 - Orientation of spring relative to arm.

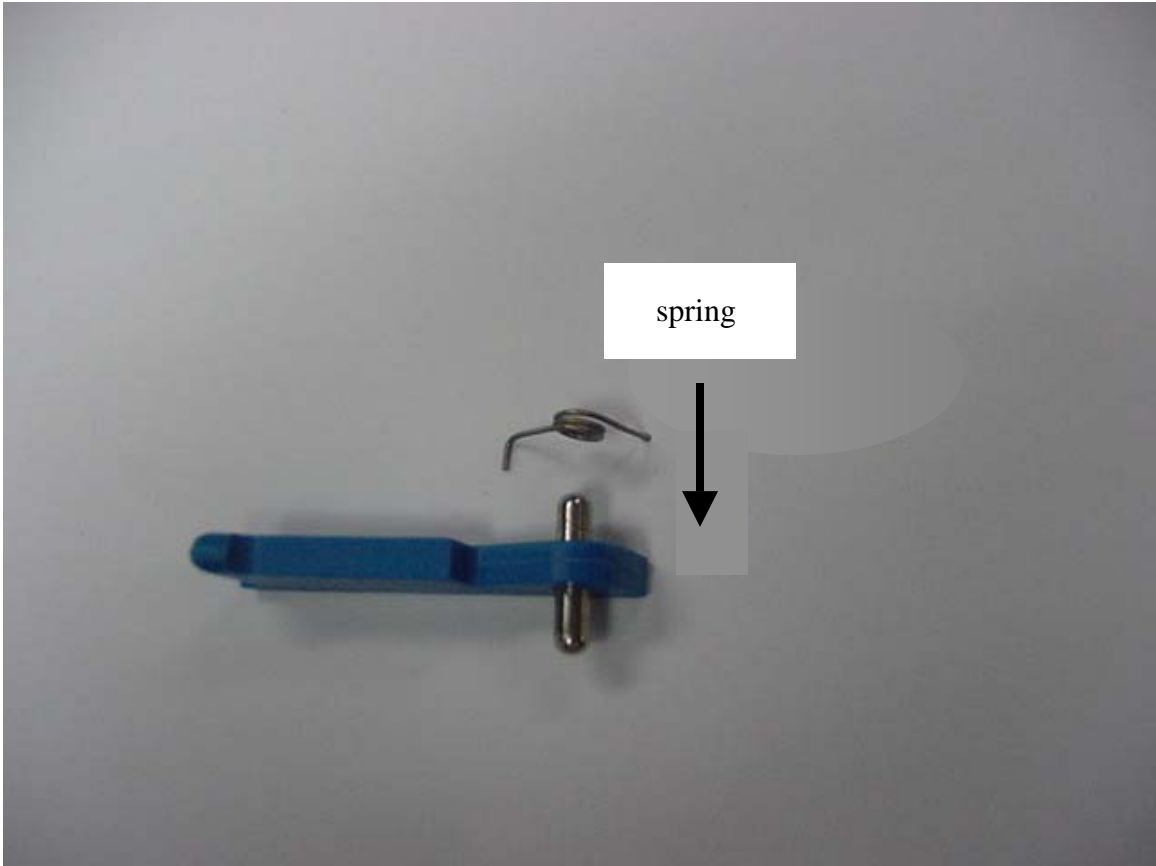

Figure C-2 - Position of spring and pivot in the arm.



Figure C-3 - Placement of arm assembly.

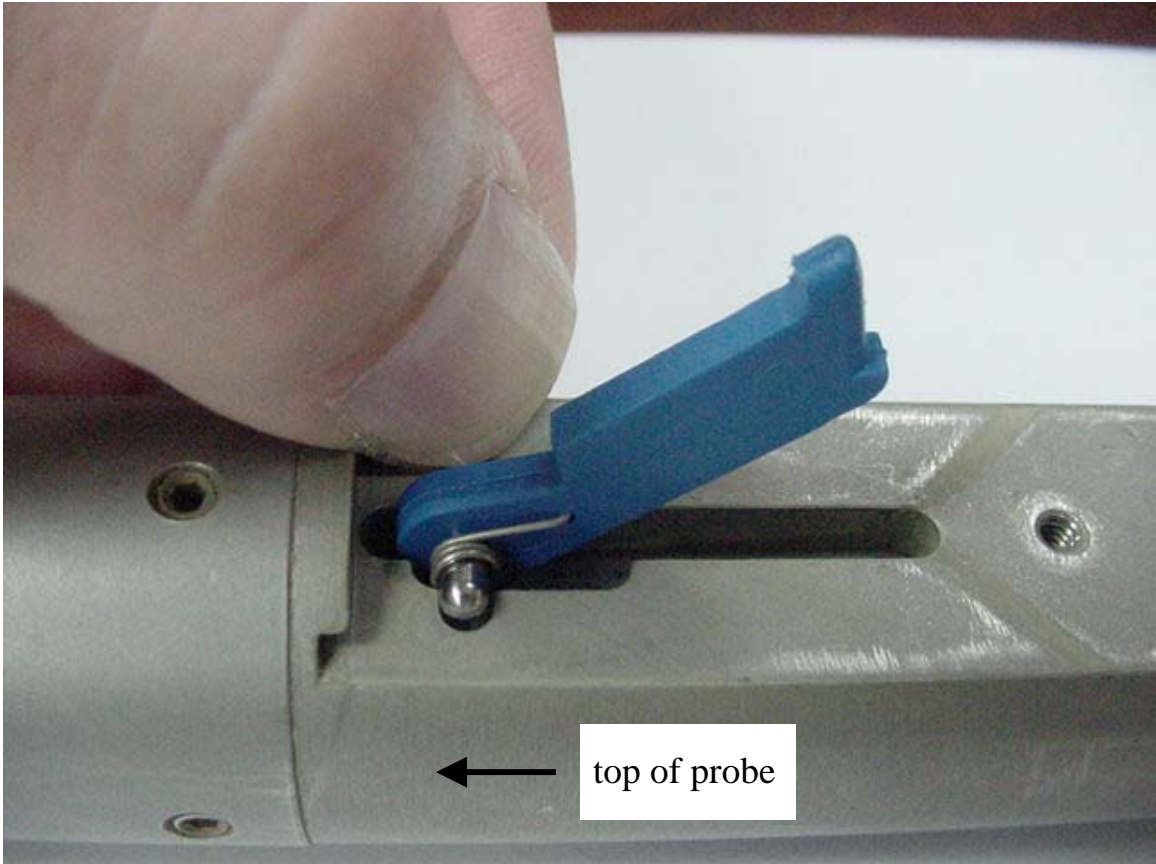
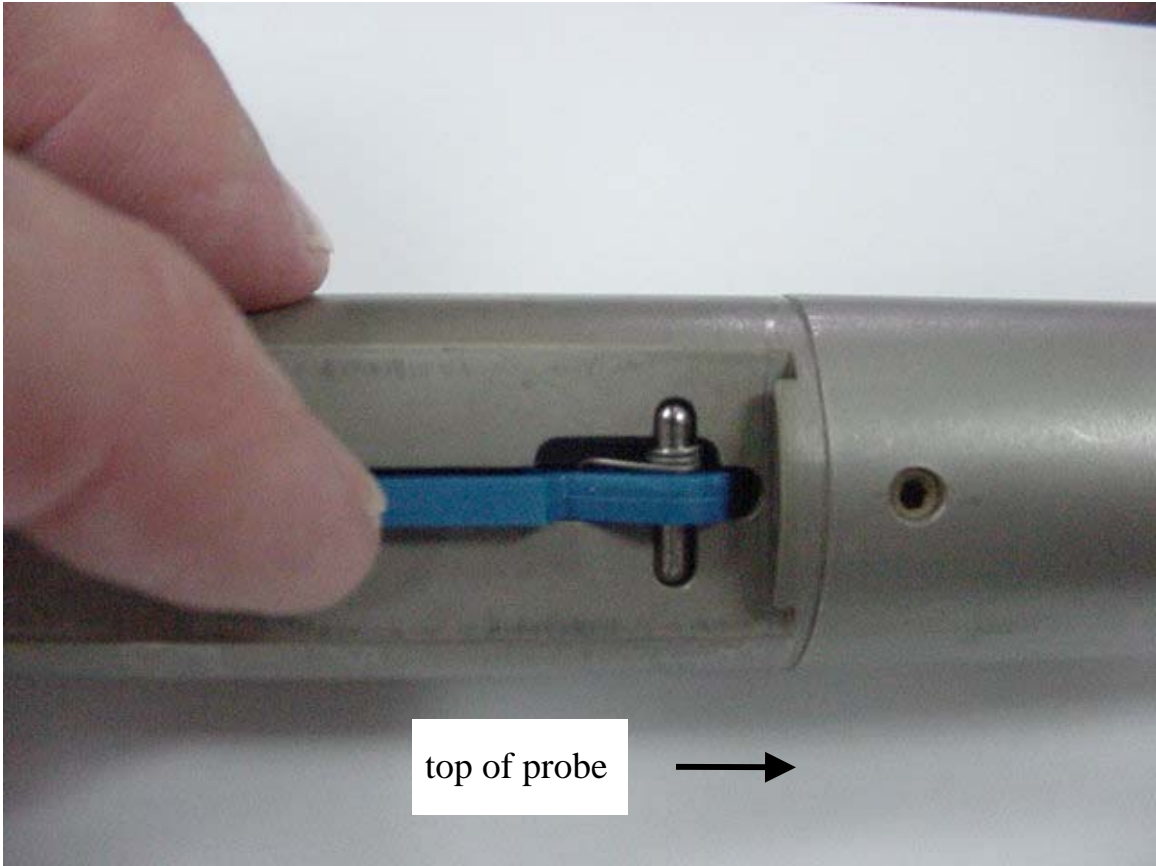

Figure C-4 - Top view of arm and spring placement.



Check that the arm is moving freely and the face seal insert and plunger are held securely in place.

4.3.3 Shoe Replacement

Activate the shoe and inspect for damage or wear. The shoe should rotate freely about the pivot pin. When the shoe is retracted it should retract quickly and smoothly back into the probe. The shoe may be replaced in the following manner:

1. Release the location arm and extend the shoe to expose the pivot pin.
2. Unscrew the shoe pivot pin from the lever arm and remove the shoe.
3. Place a new shoe in the lever arm and install the shoe pivot pin.

4.3.4 Actuator Nut

The actuator nut needs to be routinely cleaned to remove particles of grit which can interfere with its movement. Remove the actuator nut in the following manner:

1. Remove the two set screws that hold in the lever arm pivot pin. Using the Allen key, push the lever pivot pin out of the probe body.
2. Remove the set screws on the side of the probe body that holds the plastic support block.
3. Remove the screw closest to the top of the probe.
4. Lift out the lever arm, guide plate, shoe, spring and plastic support block as one unit.
5. Use the Clean Nut Command to remove the actuator nut from the actuator screw. Turn off the MPC1 and remove the nut from the probe.
6. Clean the actuator nut with the cleaning tap. Use the Clean Nut Command and clean the actuator screw with a nylon brush. **DO NOT** use a wire brush.
7. Apply a thin coating of silicone lubricant to the actuator screw. Place the actuator nut in the probe body against the actuator screw and retract the arm to thread the nut onto the actuator screw. Allow the nut to travel along the full length of the screw. **YOU MAY HAVE TO REPEAT THIS OPERATION.**
8. Install the single unit from Step 4 in the probe body. Install the lever arm pin through the probe body, lever arm, and spring. Lock the pin in position with two set screws.
9. Install the top screw into the guide plate and install the set screws to secure the support block.

5. CALIBRATION

The Westbay System permits frequent or periodic calibration of the transducers used for pressure measurement. Contact Westbay for details.

6. SPARE PARTS LIST

Item	Part No. or Size	Qty
Face Seal Insert	200302	5
Plunger	(see Note 1)	5
Location Arm	252112	5
Shoe	252313	5
Pin 3 (Location Arm)	252320	2
Spring 2 (Location Arm)	252319	2
Pin 1 (Shoe)	252316	2
Spring 1 (Shoe Lever)	252318	2
Pan Head Screw	# 4-40 x 1/4 - inch	2
Pan Head Screw	# 6-32 x 3/16 - inch	2
Pan Head Screw	# 6-32 x 1/2 - inch	2
Hex Socket Head Screw	# 8-32 x 1/8 - inch	4
Hex Socket Head Screw	# 10-32 x 3/16 - inch	4
Hex Socket Set Screw	# 8-32 x 5/16 - inch	2
Allen Key	5/64 - inch	1
Allen Key	3/32 - inch	1
Actuator Nut Tap	208001	1
Cablehead Parts:		
O-ring	# 111 B	2
Termination Sleeve	251805	1
Termination Insert	251806	1
Feedthru Connector	251814	1
Bushing 1	251812	1
Bushing 2	251813	1
O-Ring	# 108 V	1
O-Ring	# 010 V	1
O-Ring	# 004 V	1
Boot	JF0602CF	1
Contact	JF0603CF	1
Cable Heading Tool	208100	1

1. Plunger appropriate to type of measurement port to be accessed.



Groundwater Sampling

Field Data Sheet

Project: _____
 Monitoring Well No.: _____
 Sampling Zone No(s): _____

Date: _____
 Start Time: _____ Atm. Rdg: _____
 End Time: _____ Atm. Rdg: _____
 Operators: _____

Port No.	Run No.	Surface Function Tests (probe in flushing collar)						Position Sampler			Sample Collection Checks (probe located at sampling zone in Westbay casing)							Comments (volume recovered)	
		Shoe Out	Close Valve	Check Vacuum	Open Valve	Apply Vacuum	Close Valve	Locate Port	Arm Out	Land Probe	Pressure in Westbay ()	Shoe Out	Zone Pressure ()	Open Valve	Zone Pressure ()	Close Valve	Shoe In		Pressure in Westbay ()

Additional Comments: (pH, turbidity, S.C., etc.)



**Pic.1 Computer Interface Units, old and new:
MPCI model 2522 (left) and MAGI model 2536 (right)**

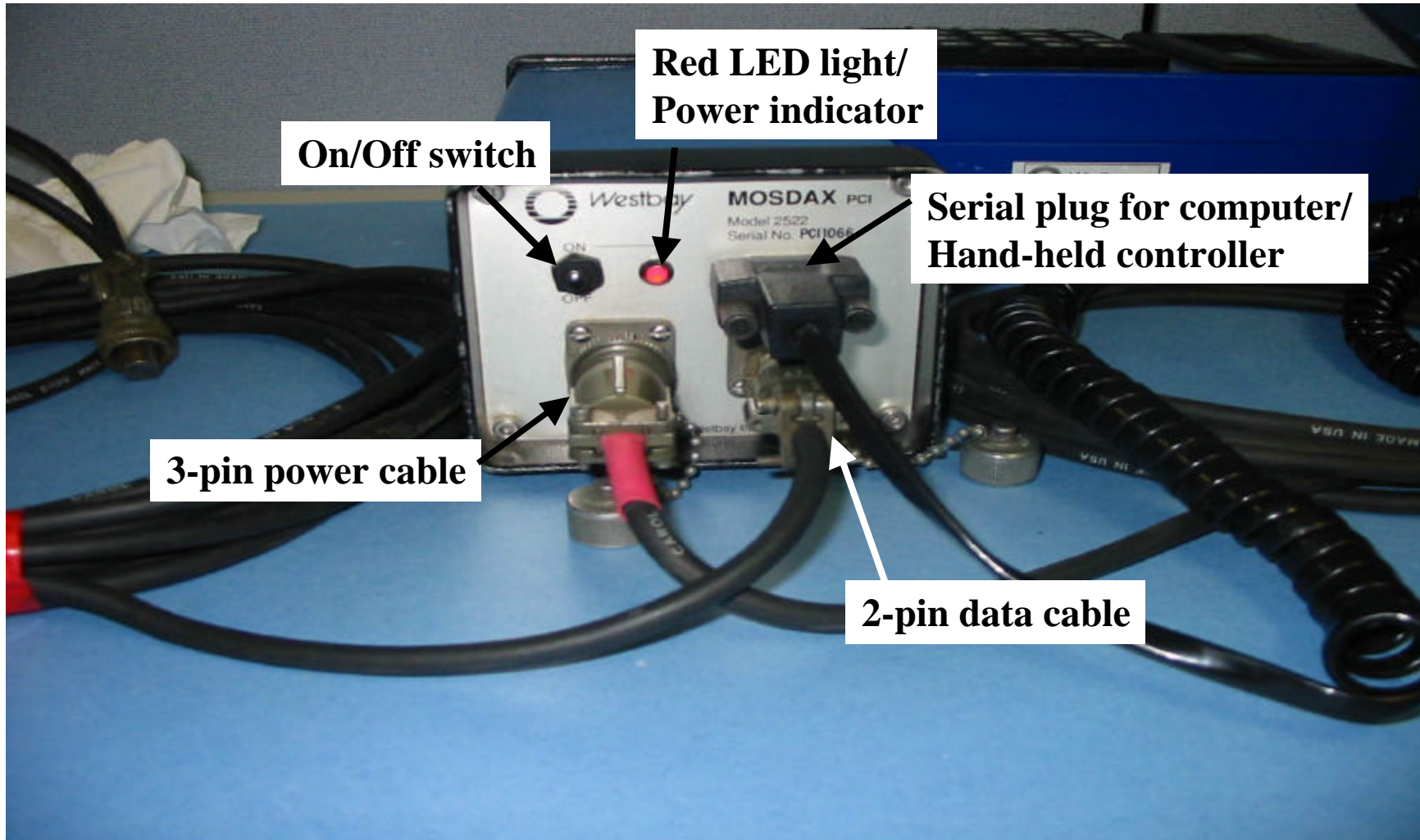

Pic.2 MPCl unit showing typical set-up configuration

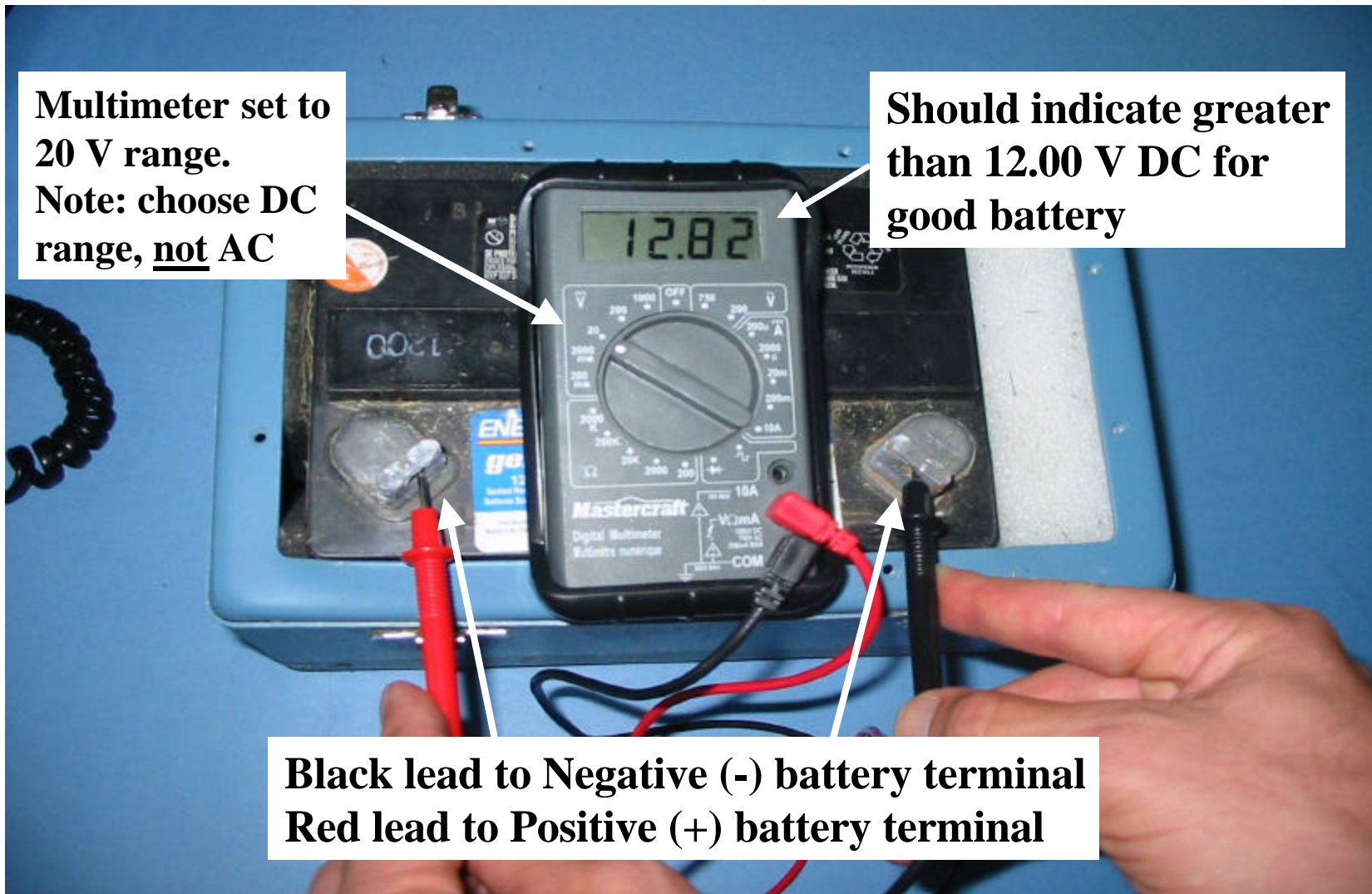

Pic.3 Testing 12 VDC Power Supply using Multimeter

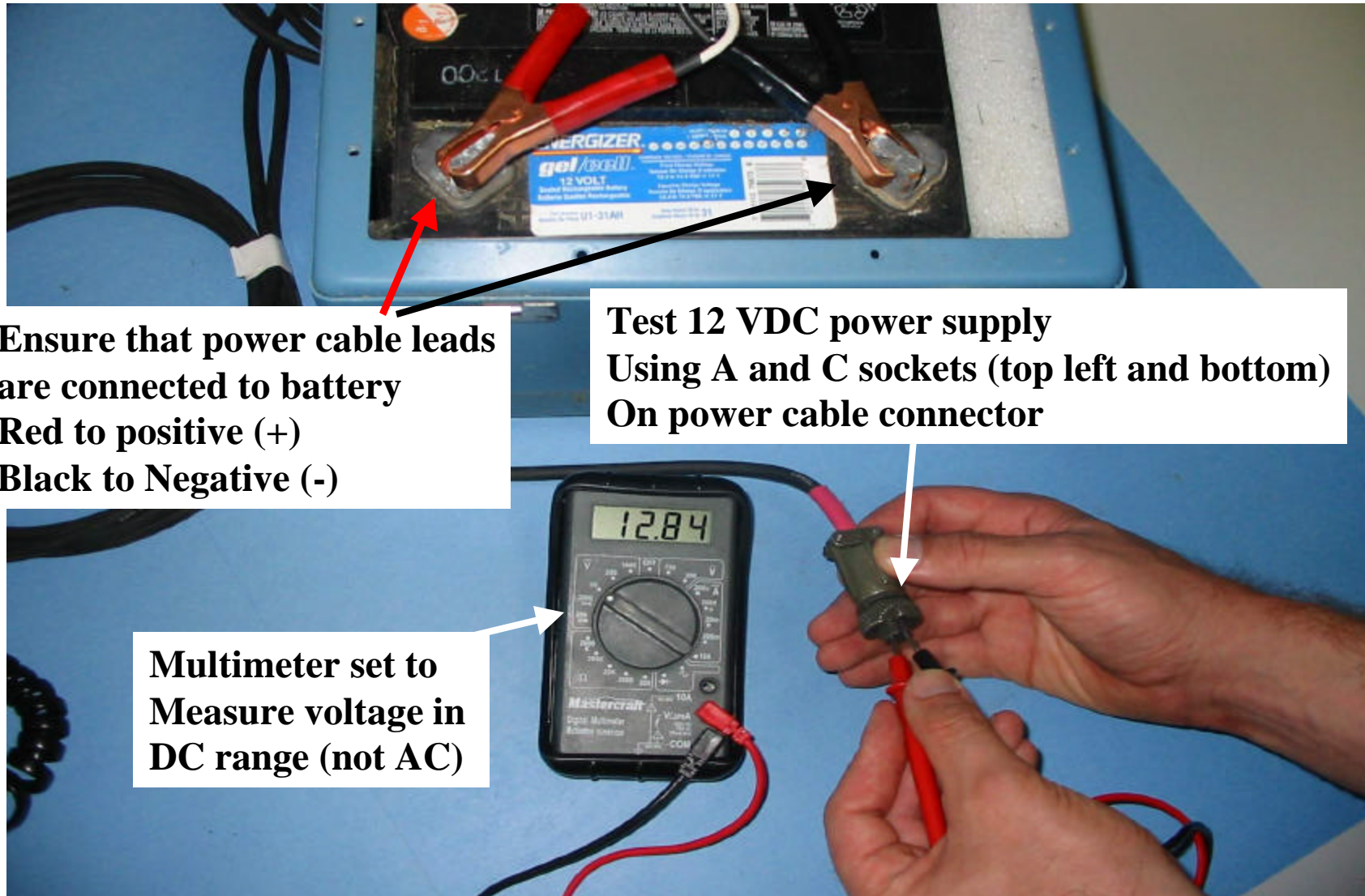

**Ensure that power cable leads
are connected to battery
Red to positive (+)
Black to Negative (-)**

**Test 12 VDC power supply
Using A and C sockets (top left and bottom)
On power cable connector**

**Multimeter set to
Measure voltage in
DC range (not AC)**

**Pic.4 Testing Power Cable Voltage
(should indicate greater than 12.00 V DC for good battery and cable)**

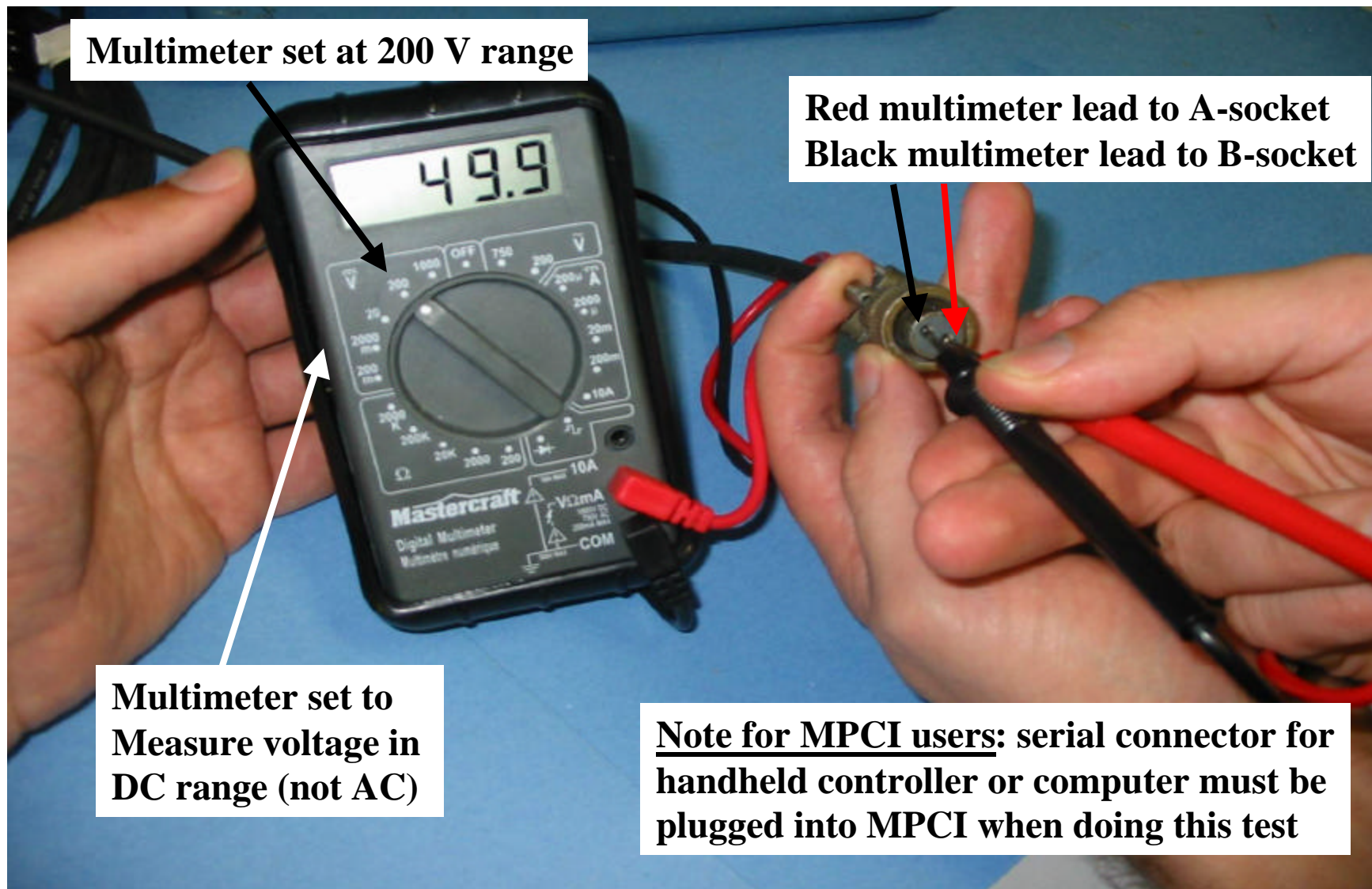

Pic.5 Testing Power output from MPCCI or MAGI using data cable (should be greater than 48 V) *Note: MPCCI/MAGI must have power 'on' and be connected to power supply.*

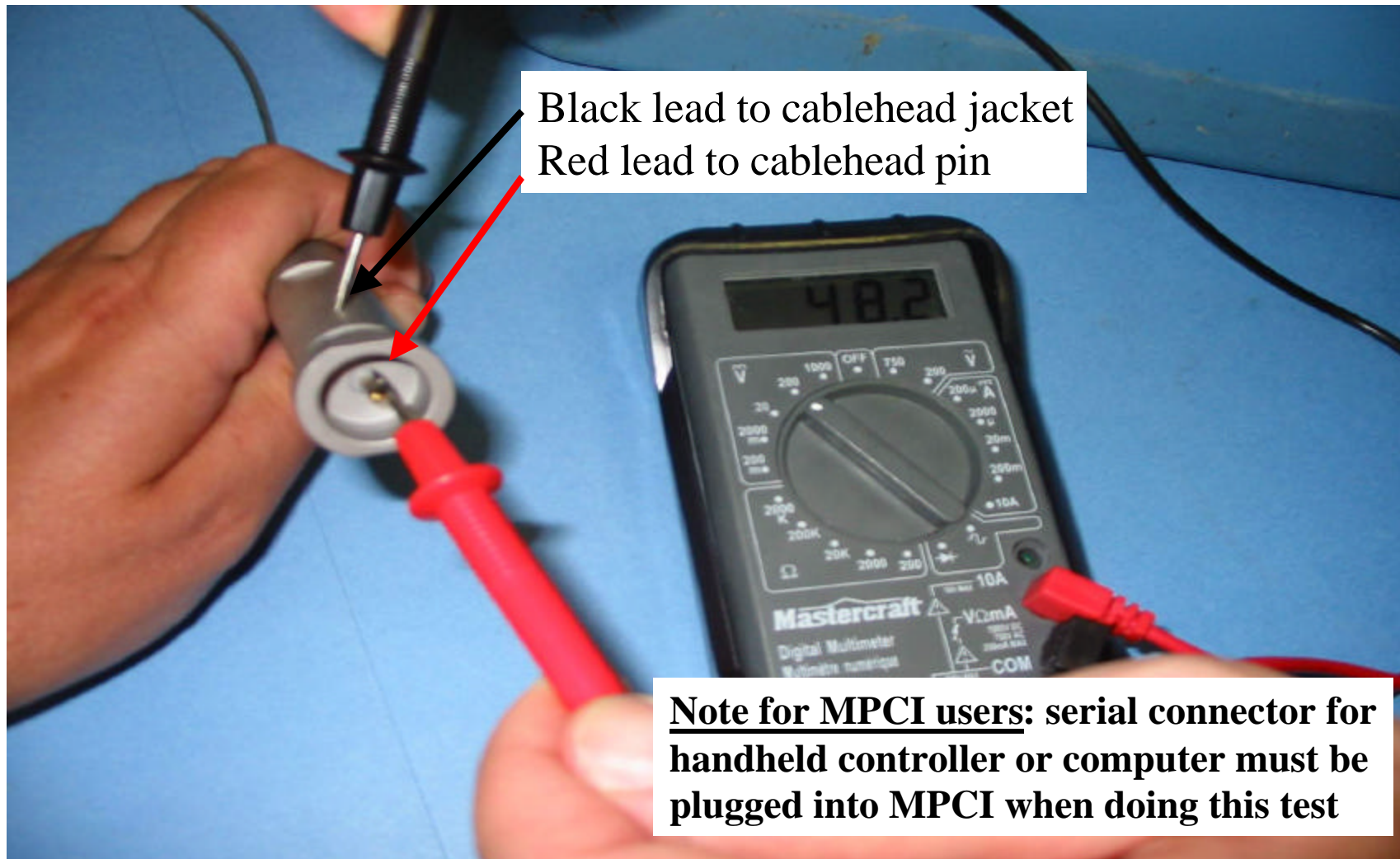

Pic.6 Checking power output at cablehead (should be greater than 48 V)
Note: MPCII/MAGI must have power 'on' and be connected to power supply.

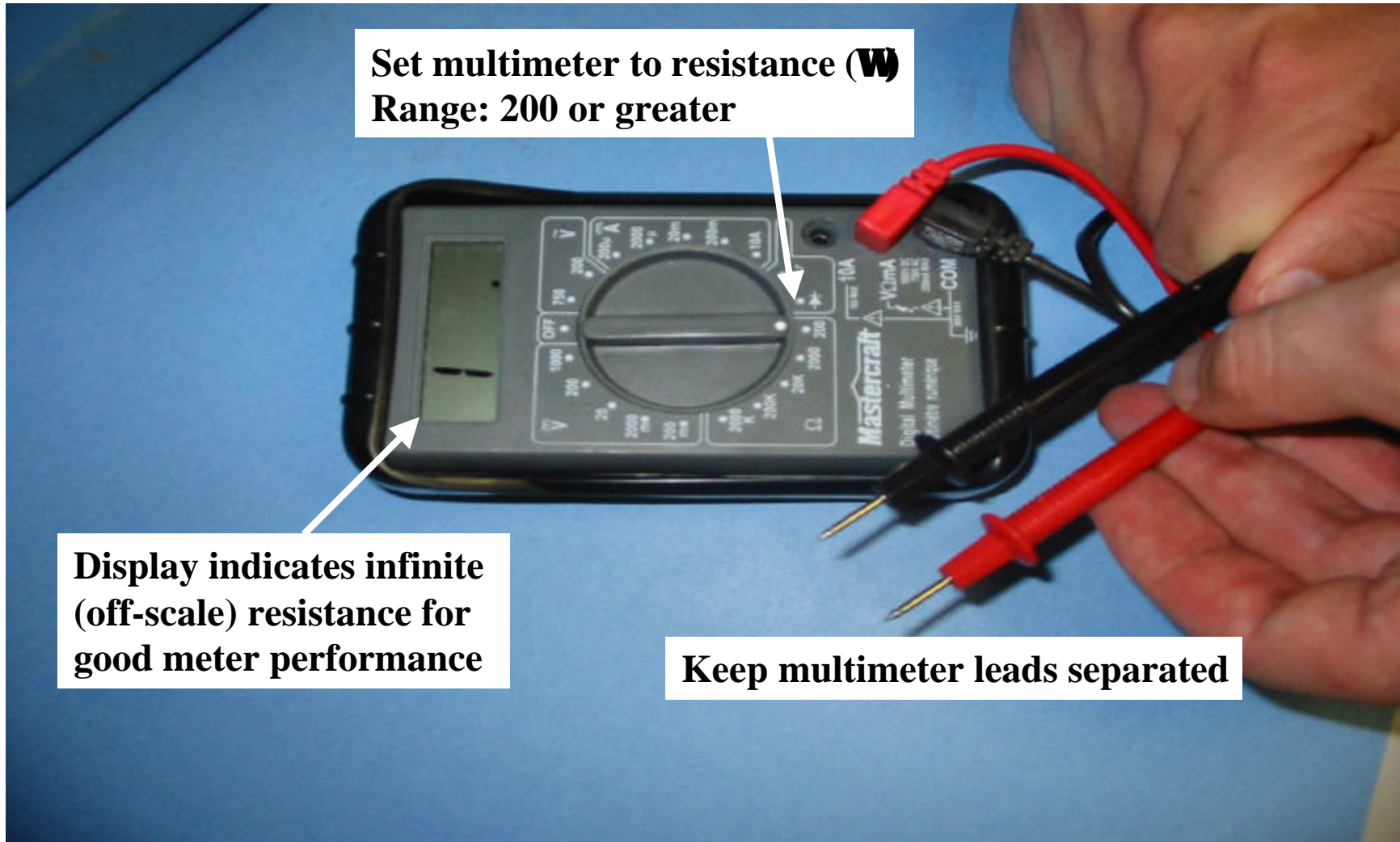

Pic.7 Test multimeter “open” resistance

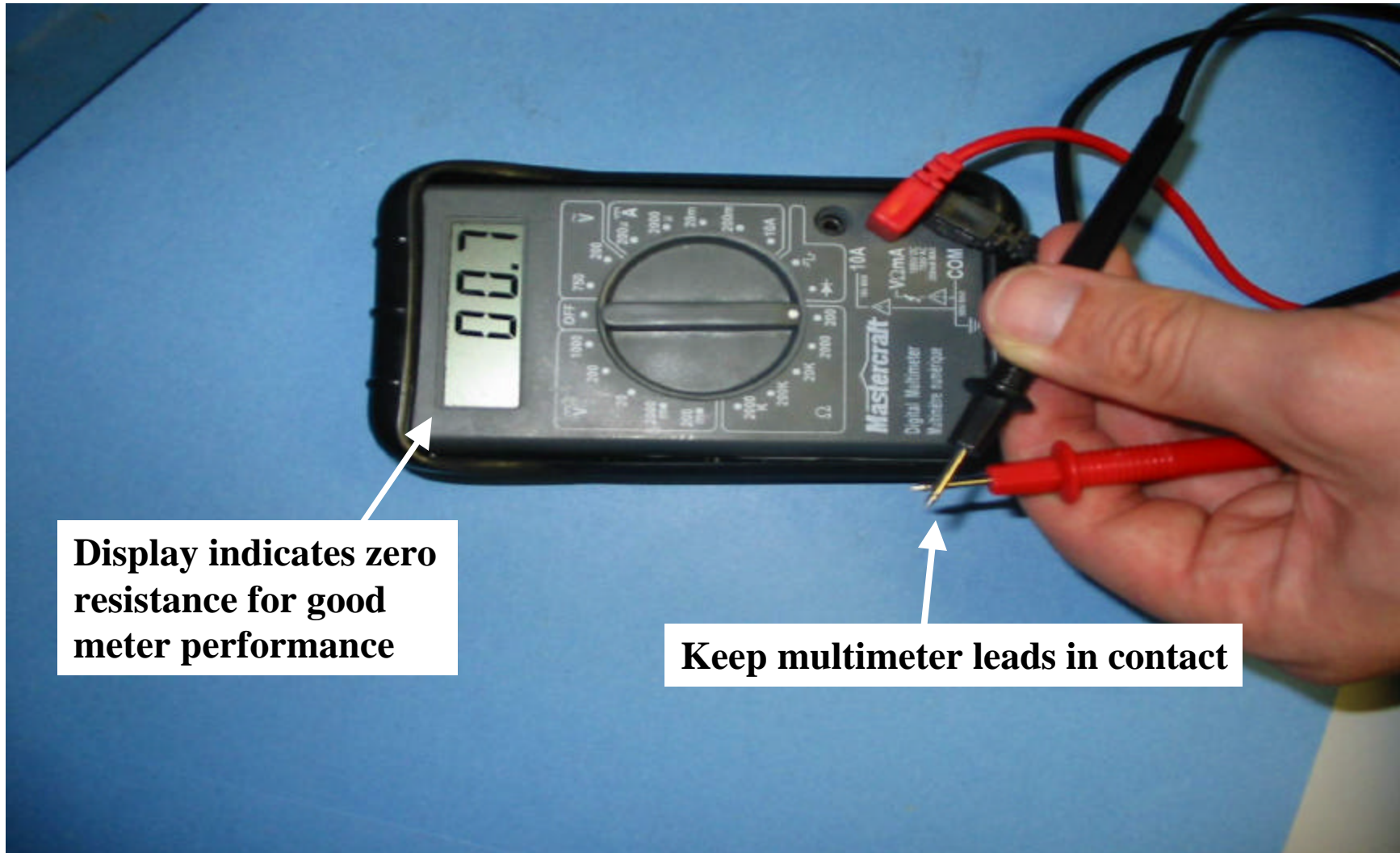

Display indicates zero resistance for good meter performance

Keep multimeter leads in contact

Pic.8 Test multimeter “closed” resistance

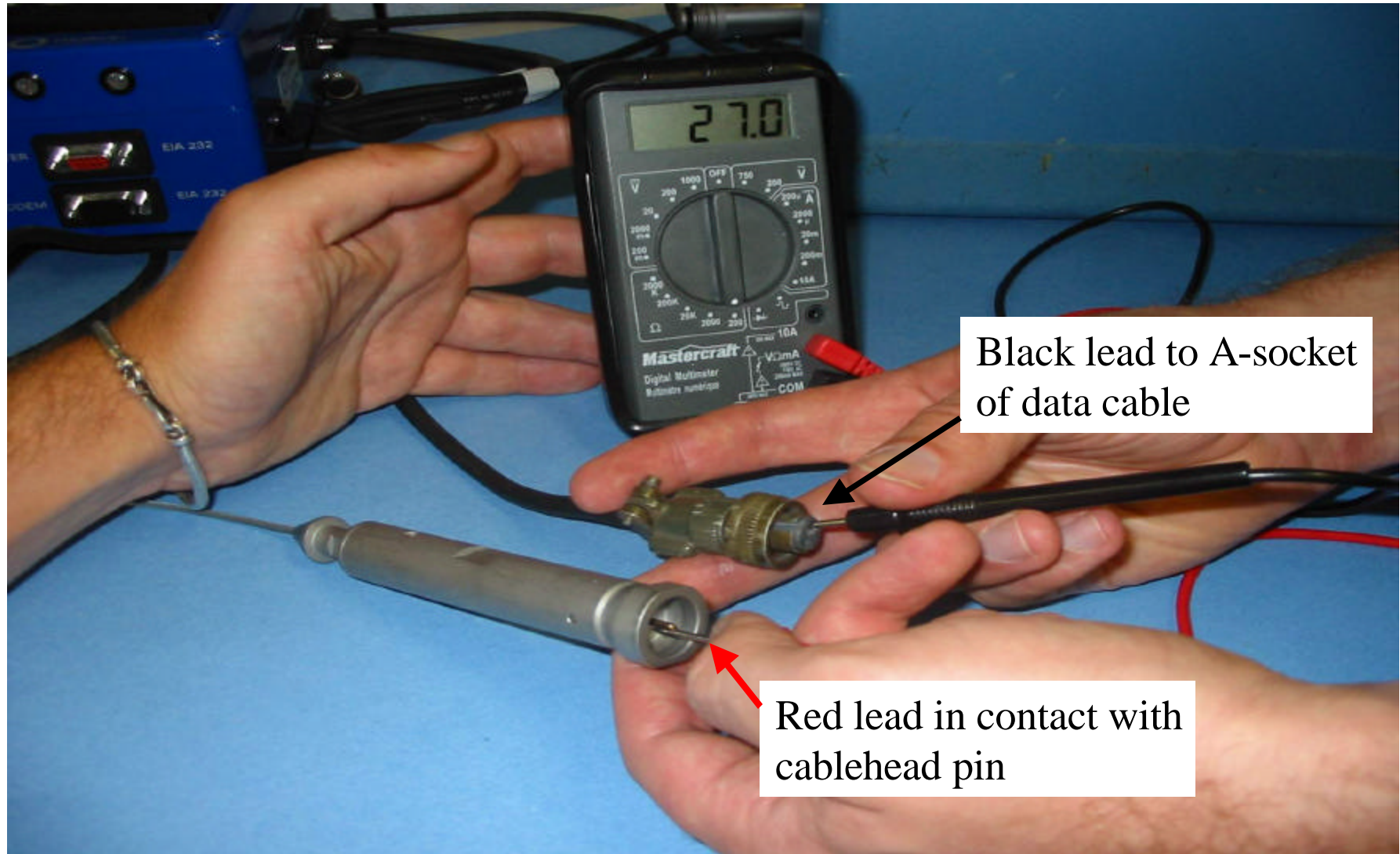

Pic.9 Test wireline 'A-A' resistance (approx. 27 Ω /1000 ft)

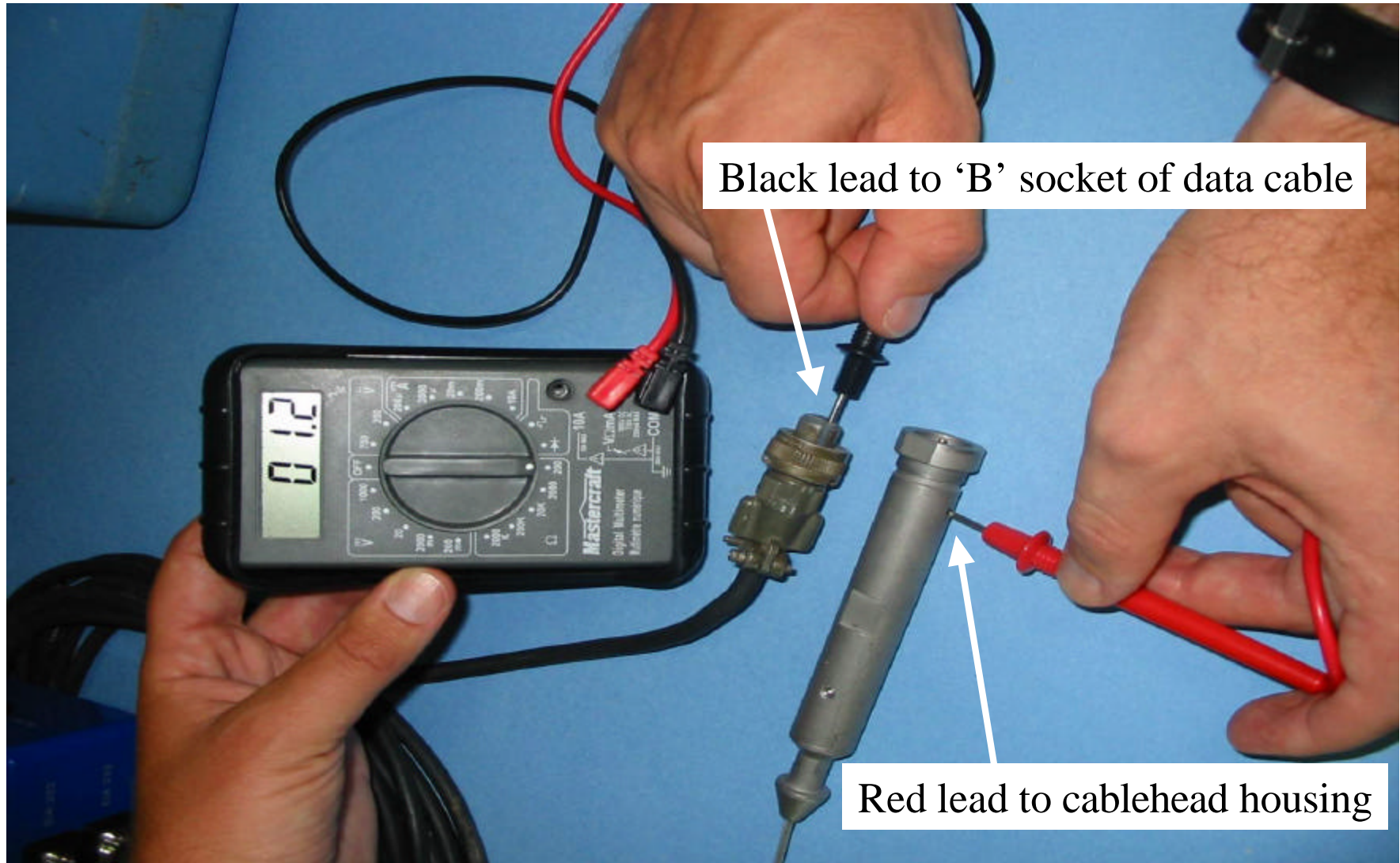

Pic.10 Test wireline 'B-B' resistance (should be less than 'A-A')

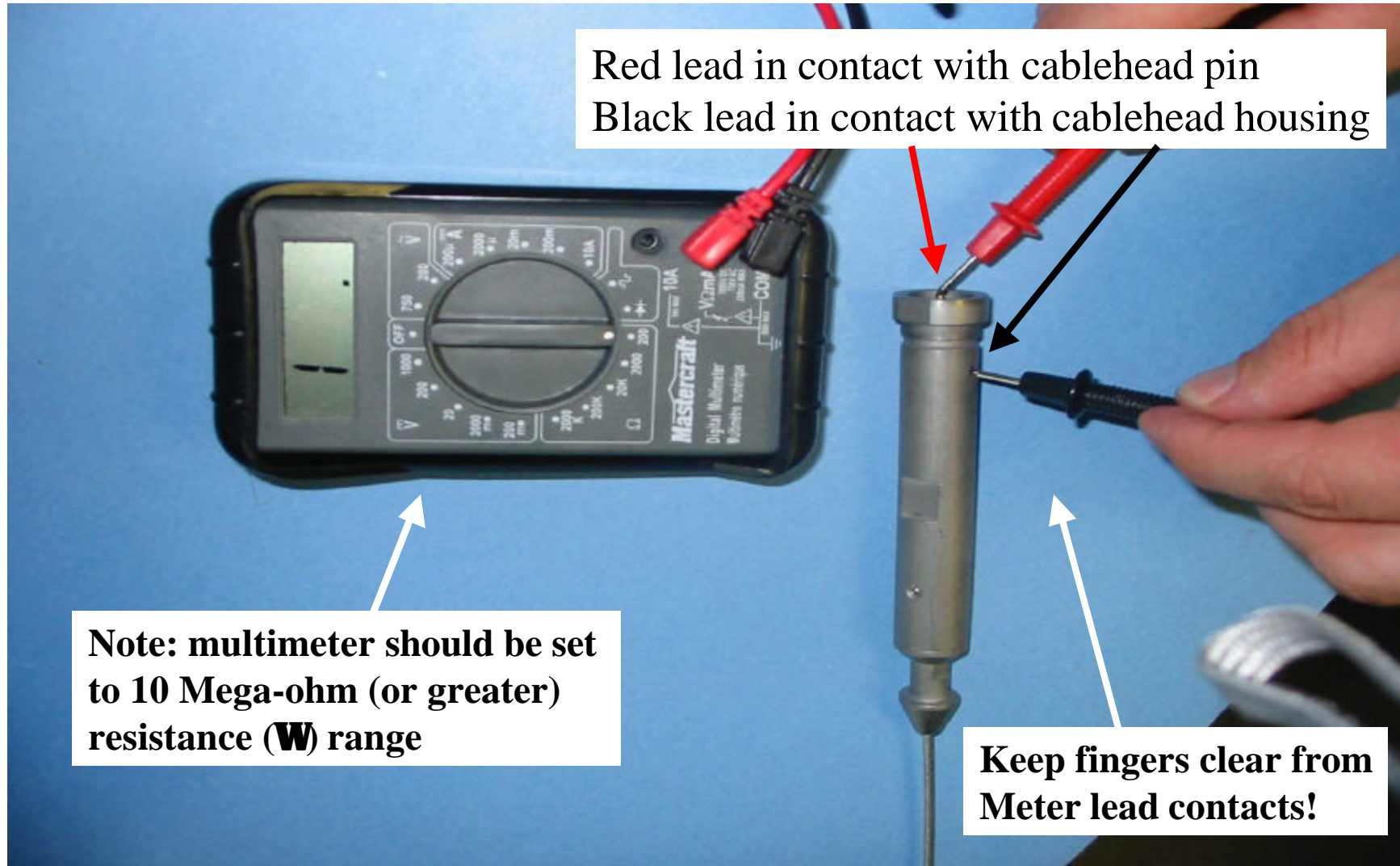

Pic.11 Test wireline 'A-B' resistance at cablehead (should be off-scale)

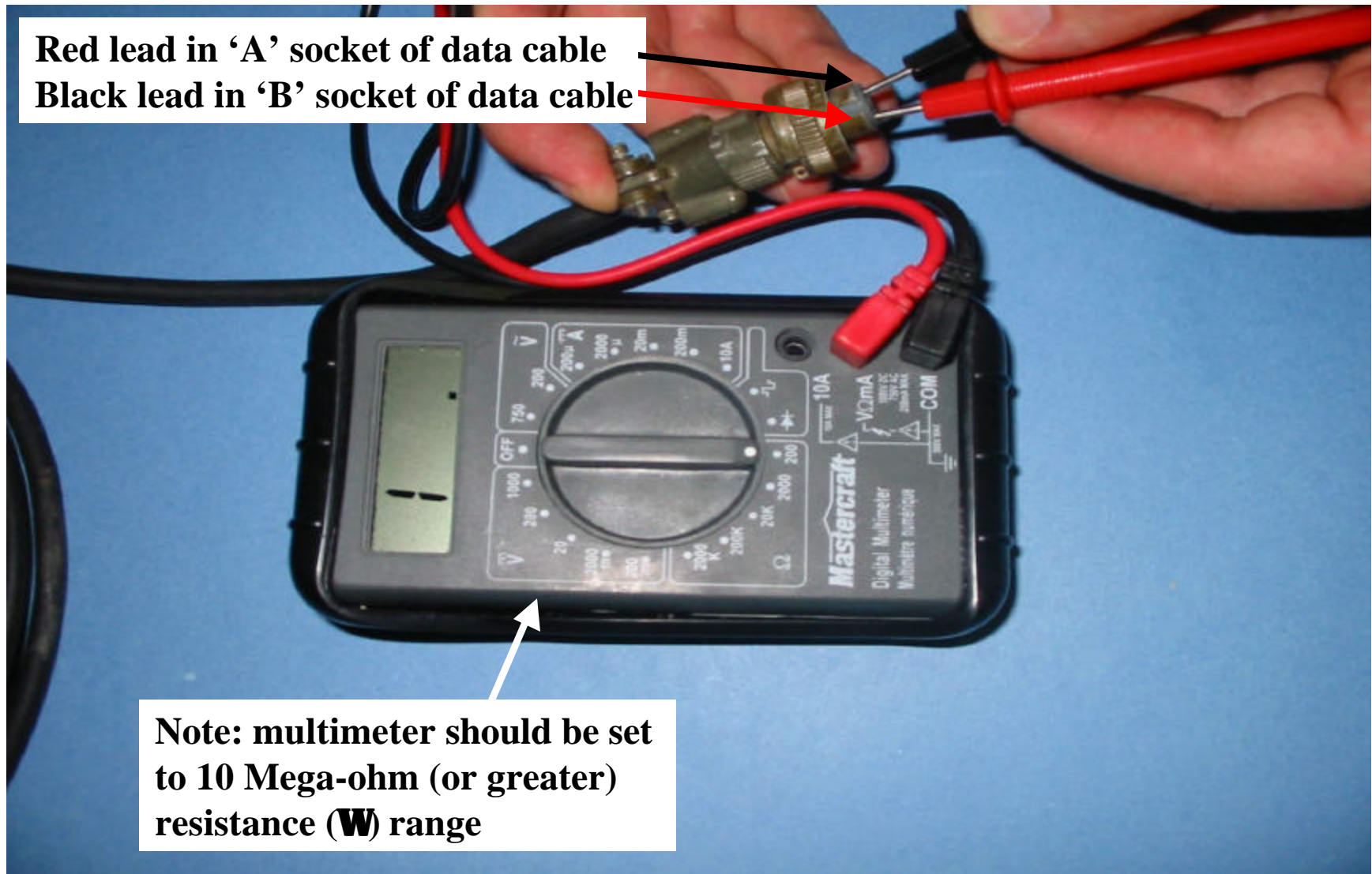

Pic.11 Test wireline 'A-B' resistance at data cable (should be off-scale)



Pic.1 Identification of Cable Damage



Pic.2 Cablehead Disassembly (1): Loosen set Screws

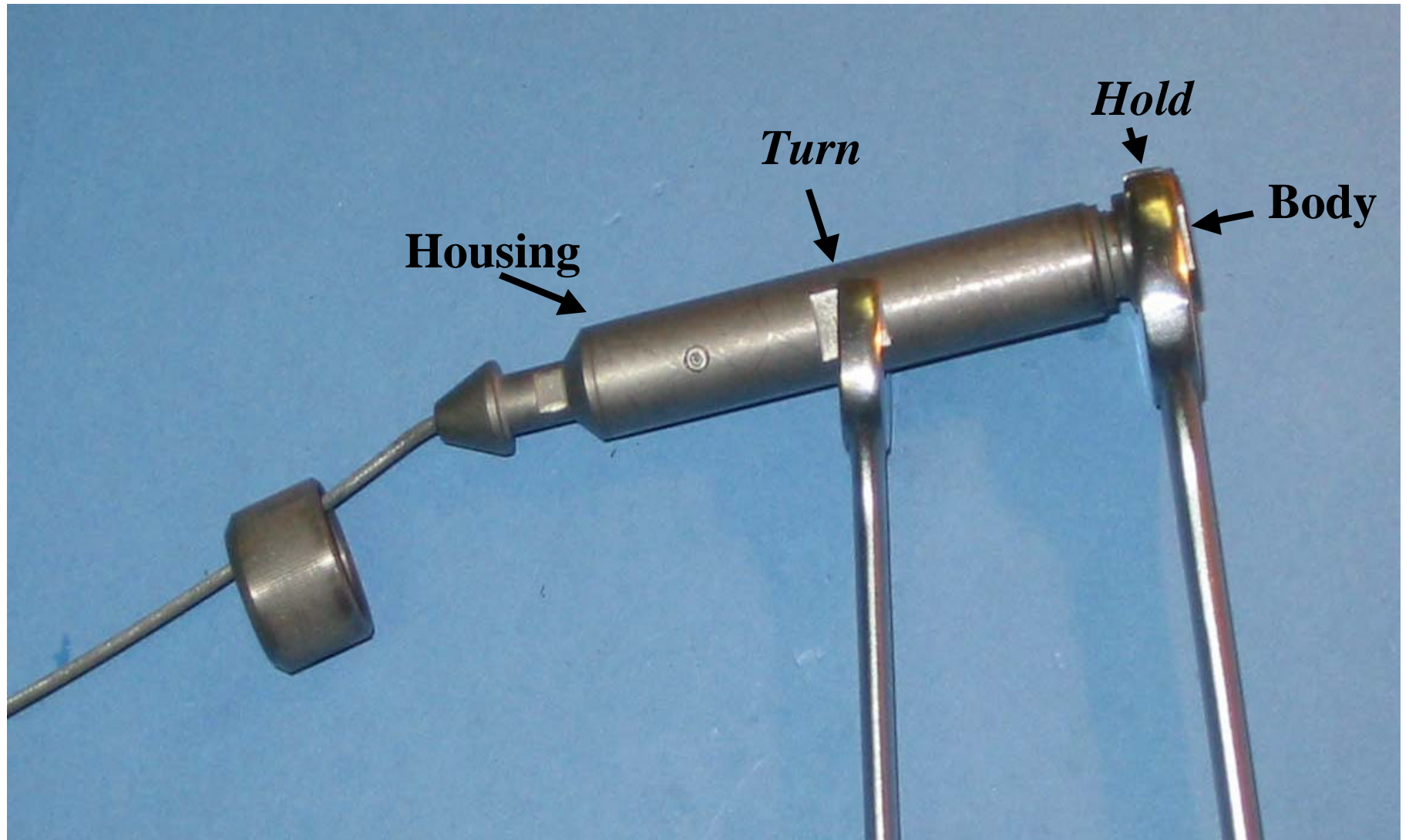

Pic.3 Cablehead Disassembly(2): Unscrew Housing From Body

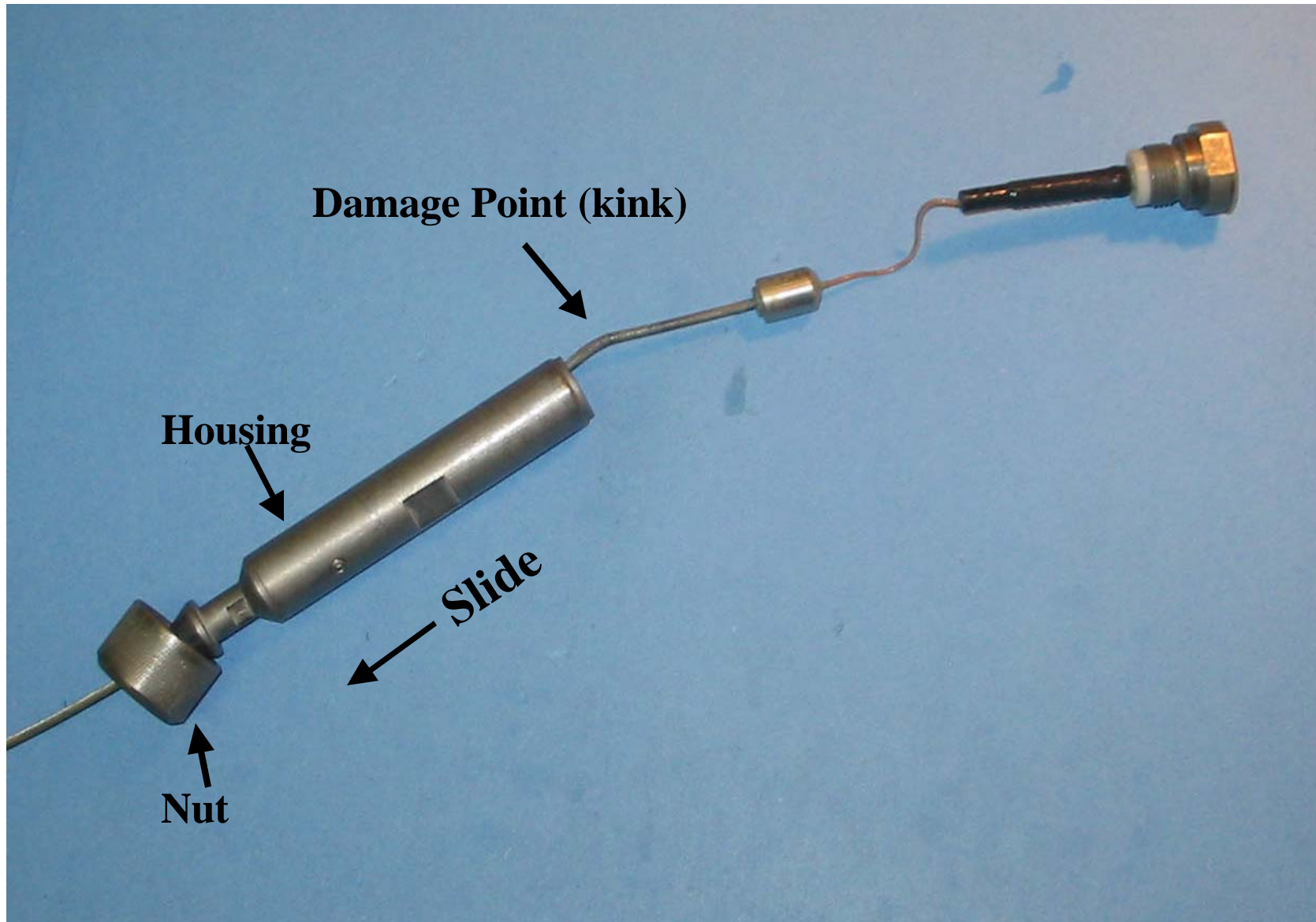

**Pic.4 Cablehead Disassembly(3):
Slide Housing and Cablehead Nut Past Damage Point**

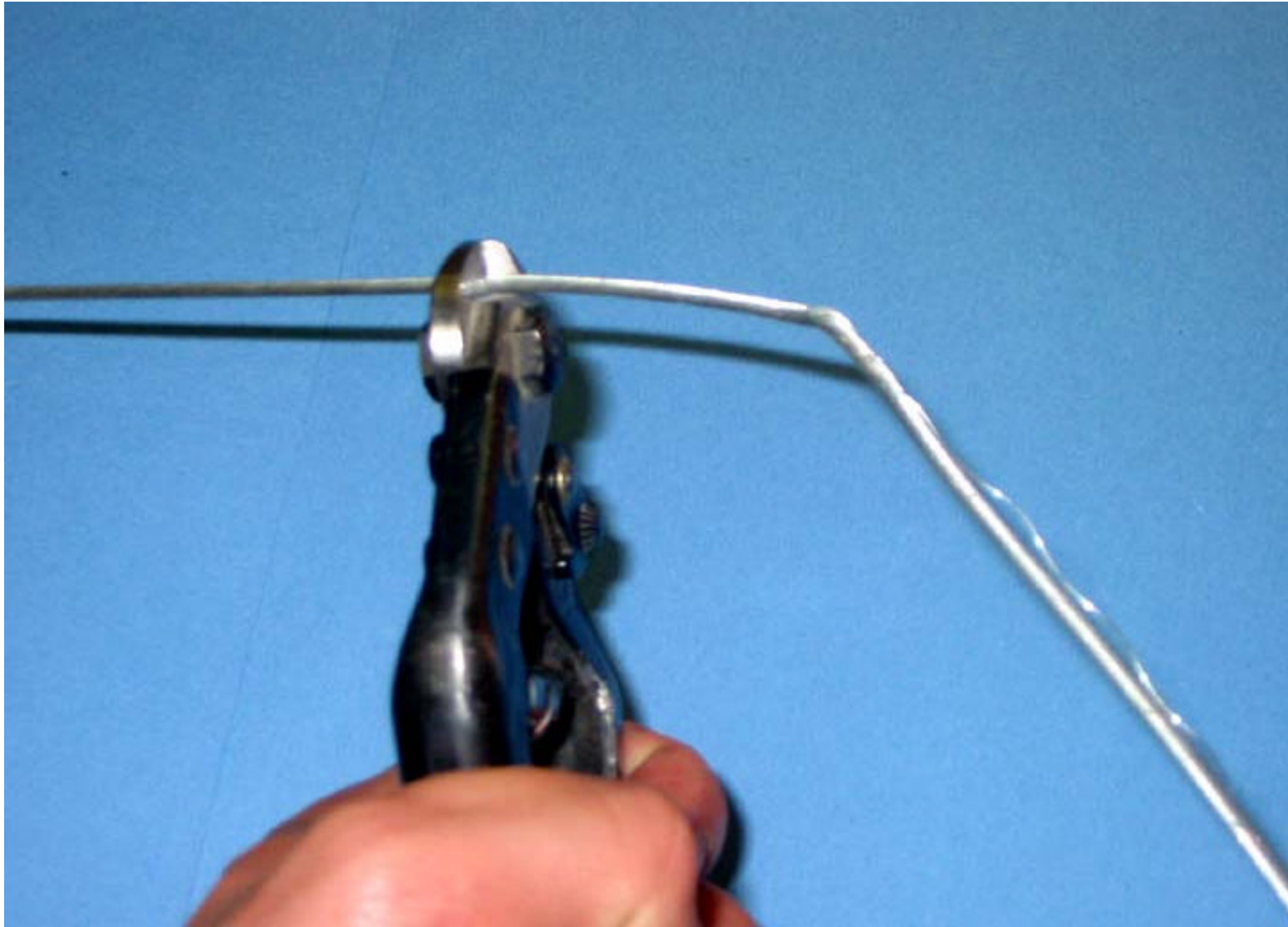

Pic.5 Cut Cable above Damage Point

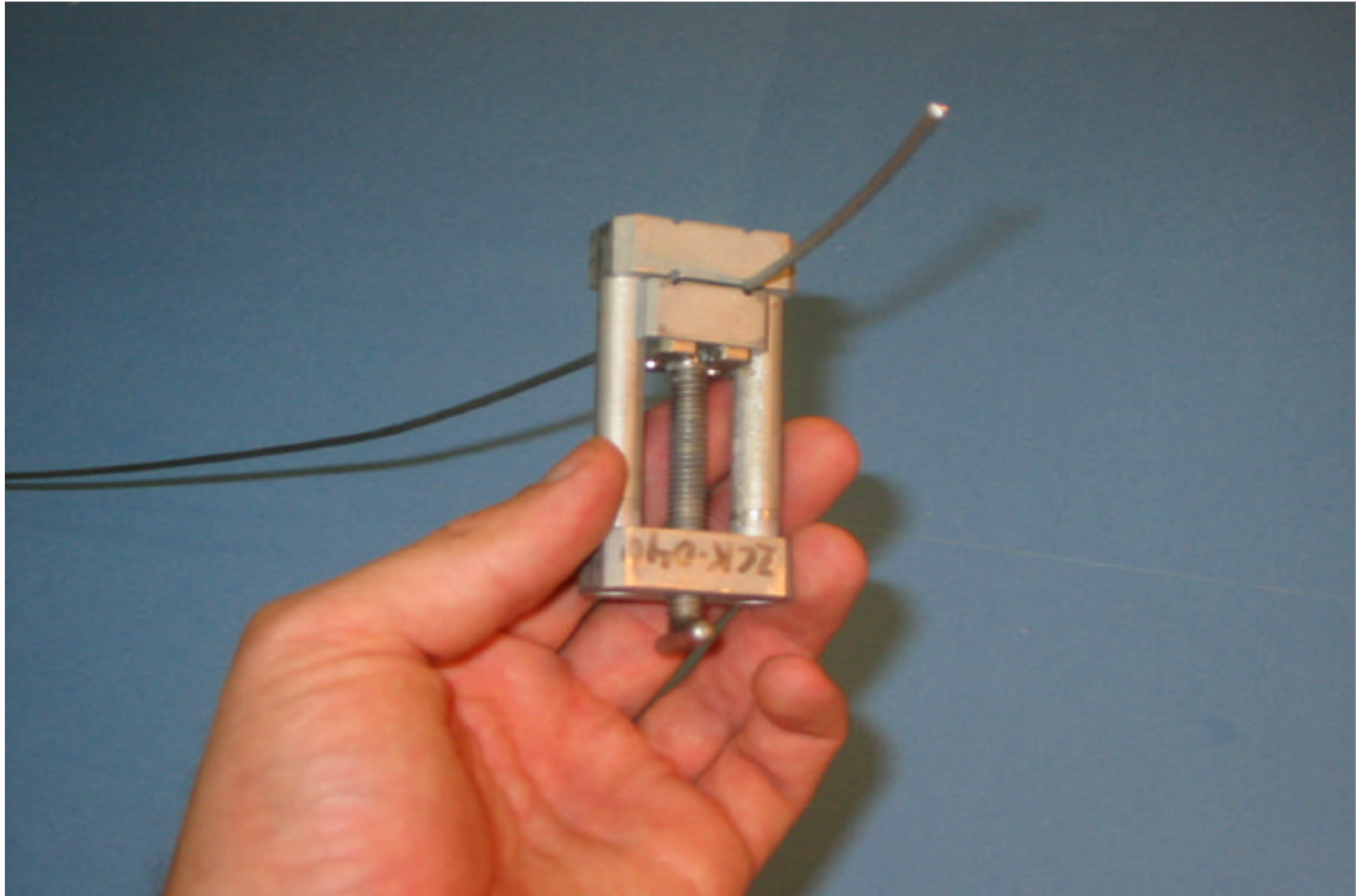

Pic.6a Clamp Cable in Termination Jig

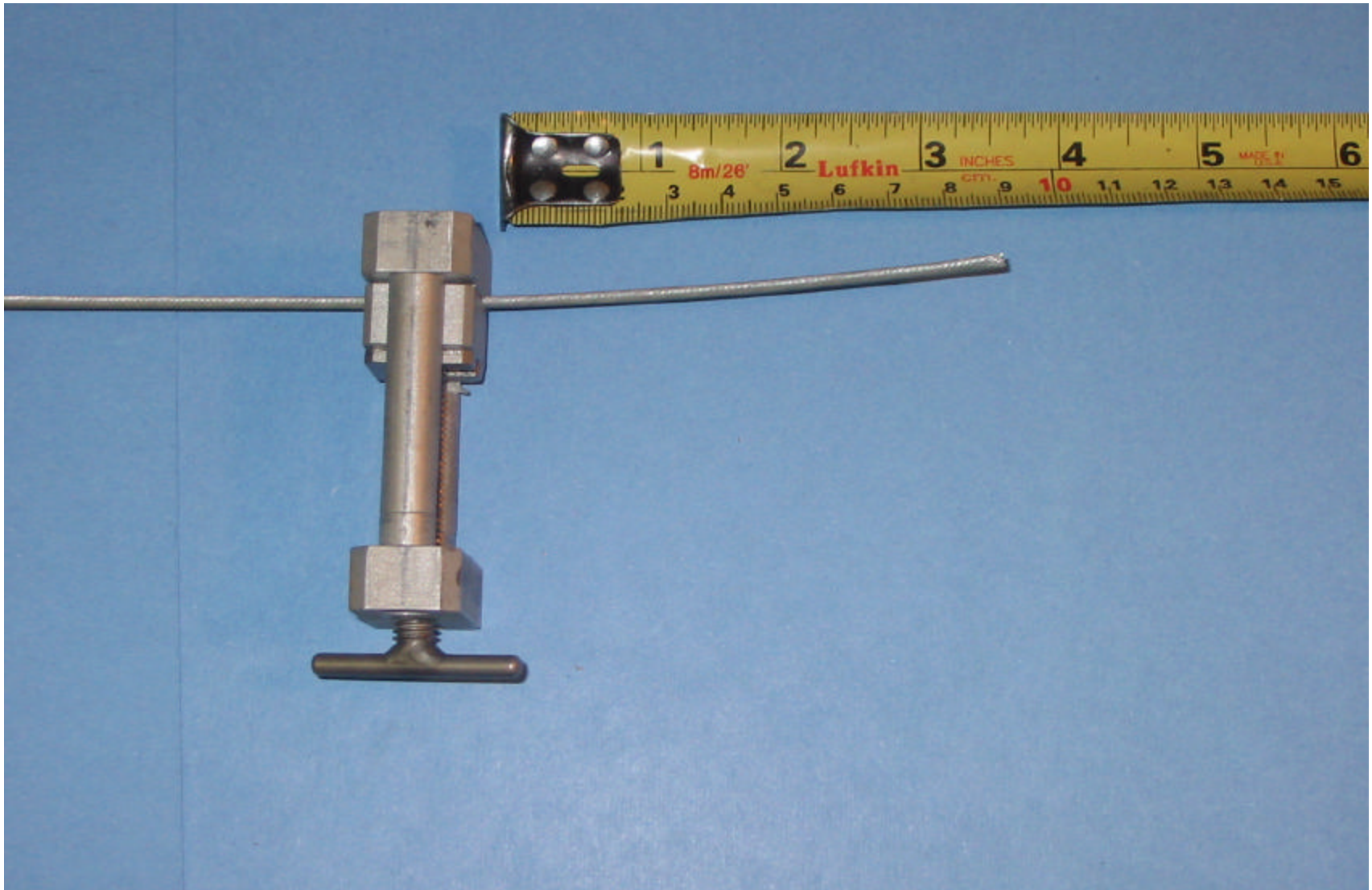

Pic.6b Leave 3.5 inches Cable Exposed

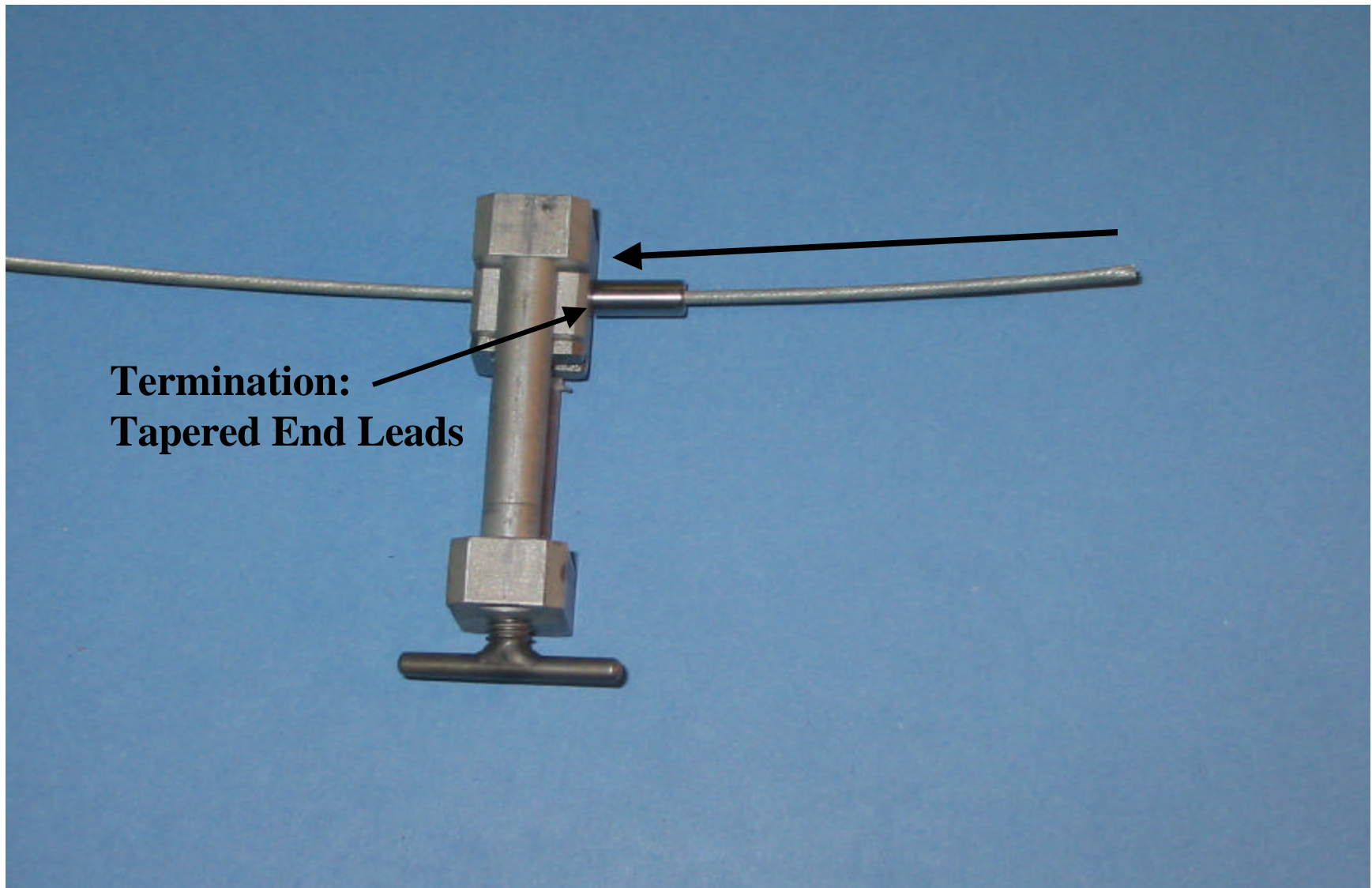

Pic.6c Slide Termination Insert Over Cable

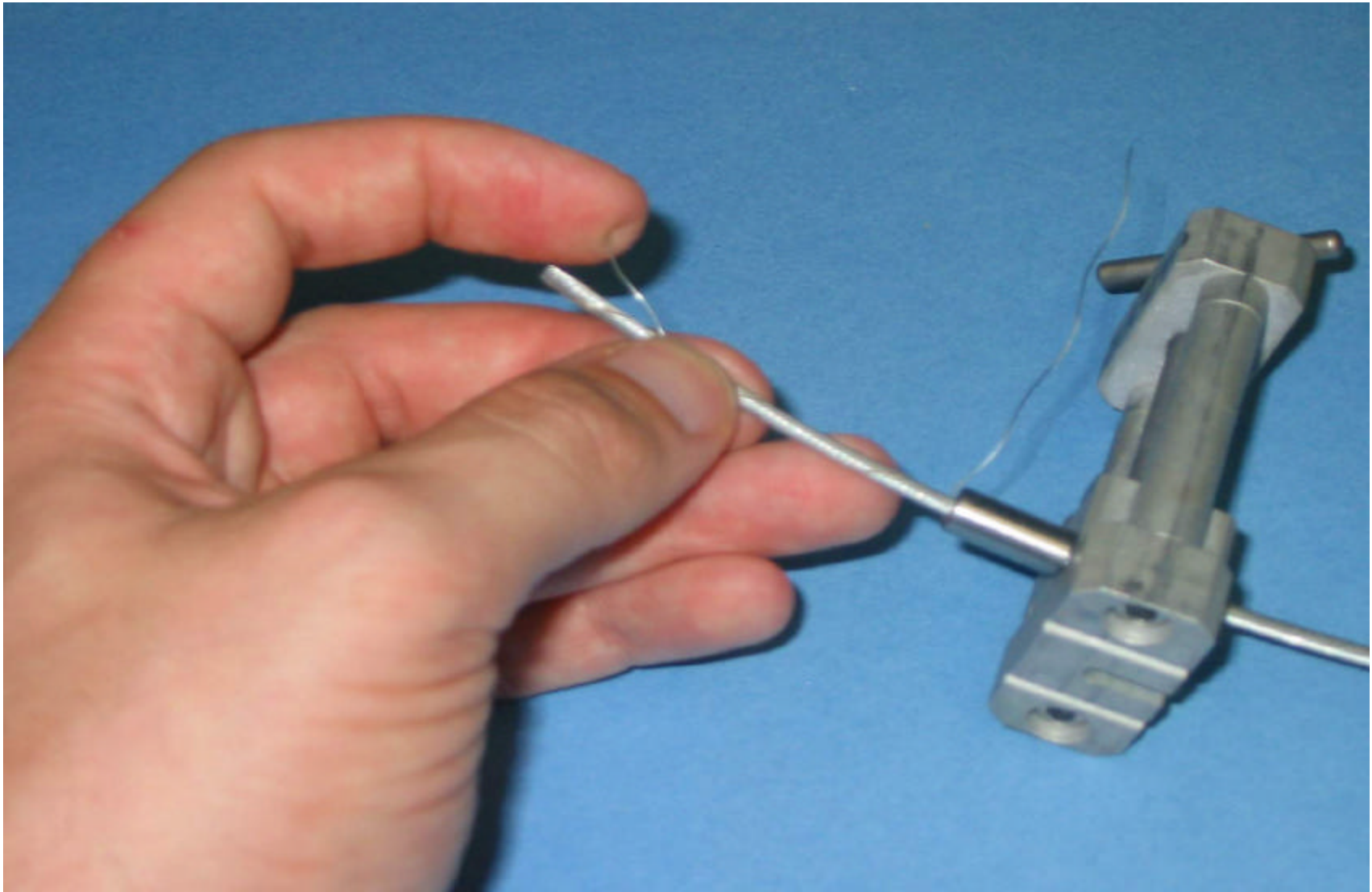

Pic.7a Unwind Outer-layer Strands (start)

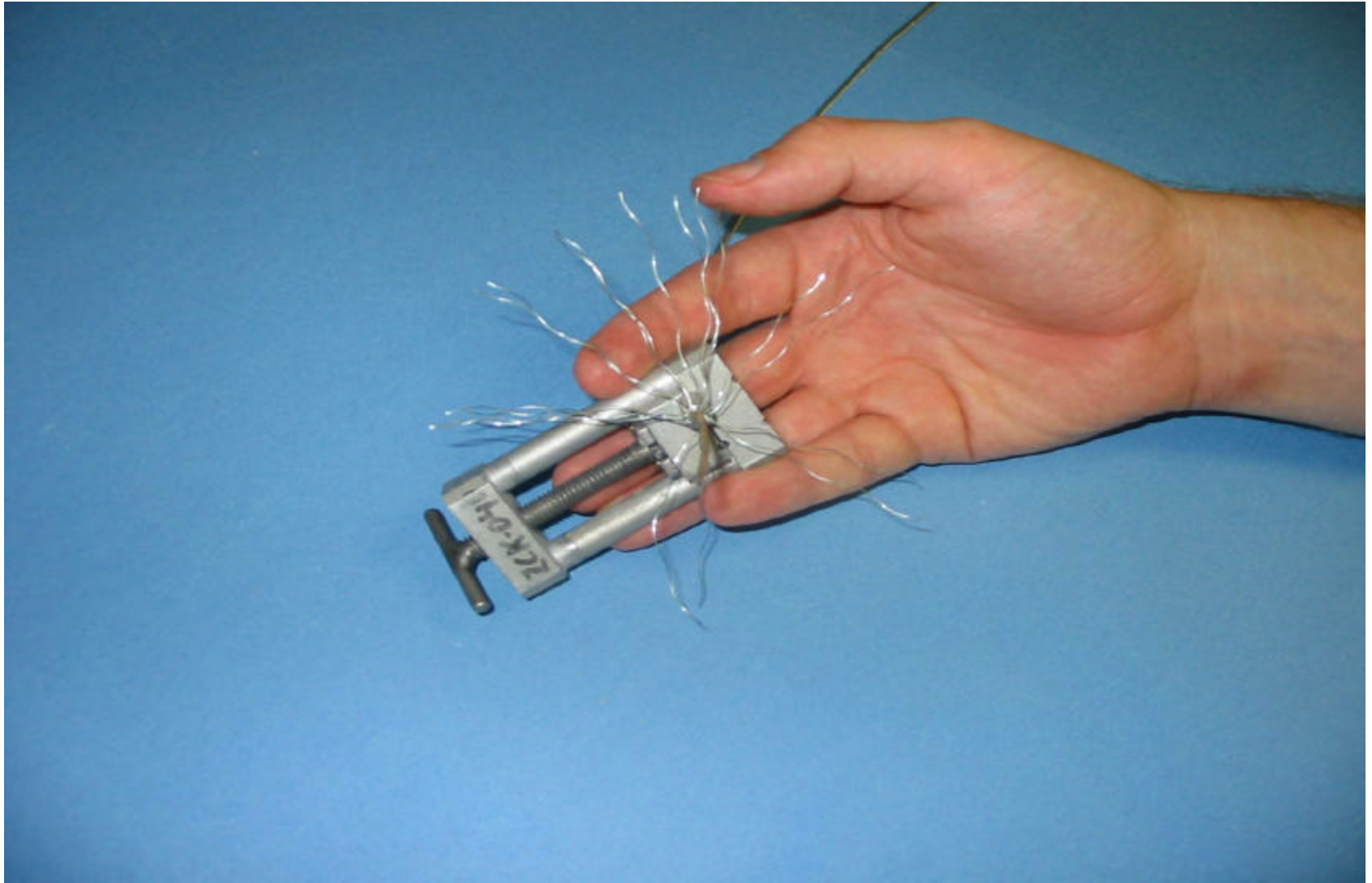

Pic.7b Unwind Outer Layer Strands (finish)

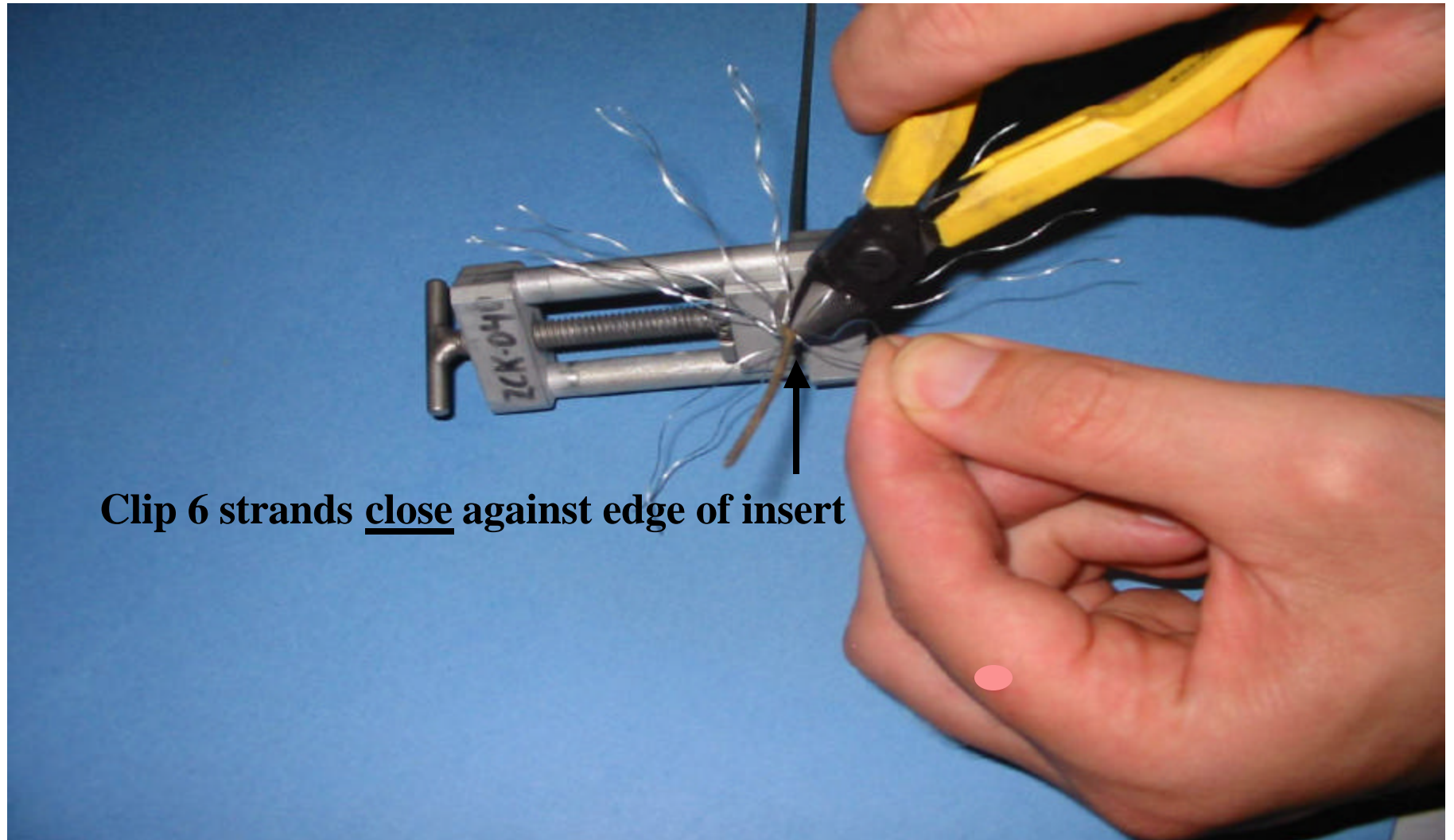

Pic.8 Clipping Outer Wire Strands (6 strands out of 18)

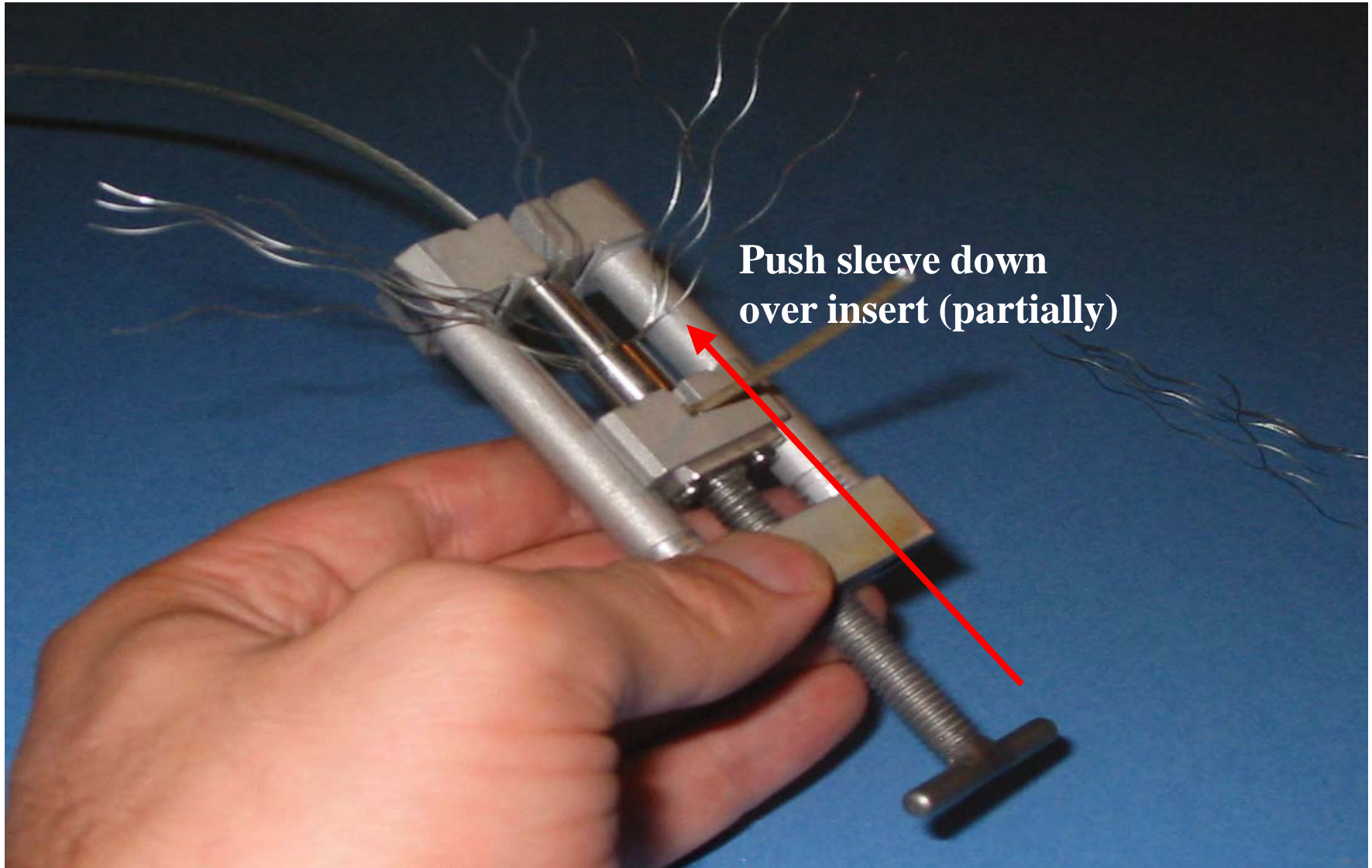

**Pic.9 Partially Push Sleeve Down on Insert Using Jig
(enough to bend strands down along insert)**

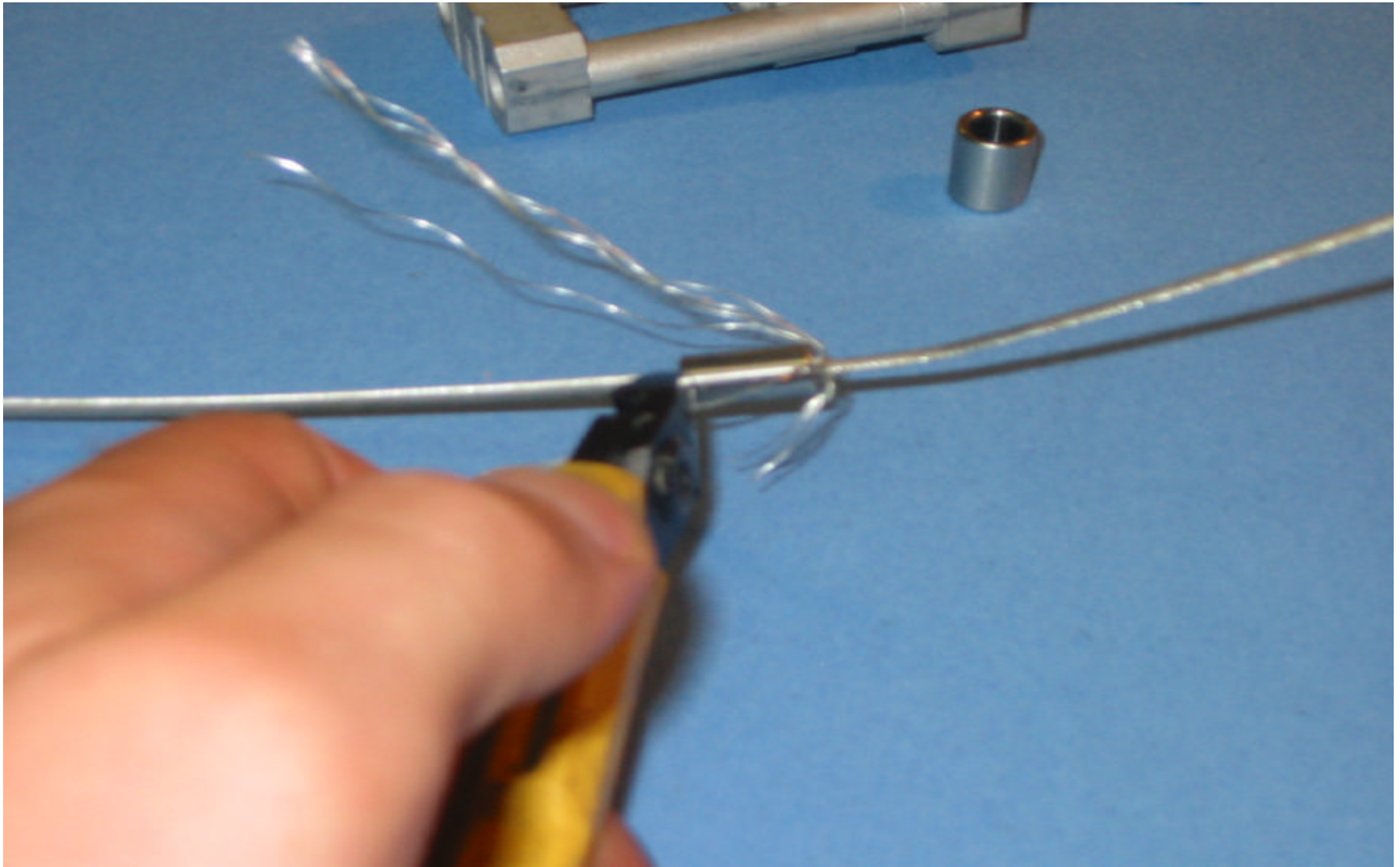

Pic.10 Trim Outer Wire Strands to Base of Insert.

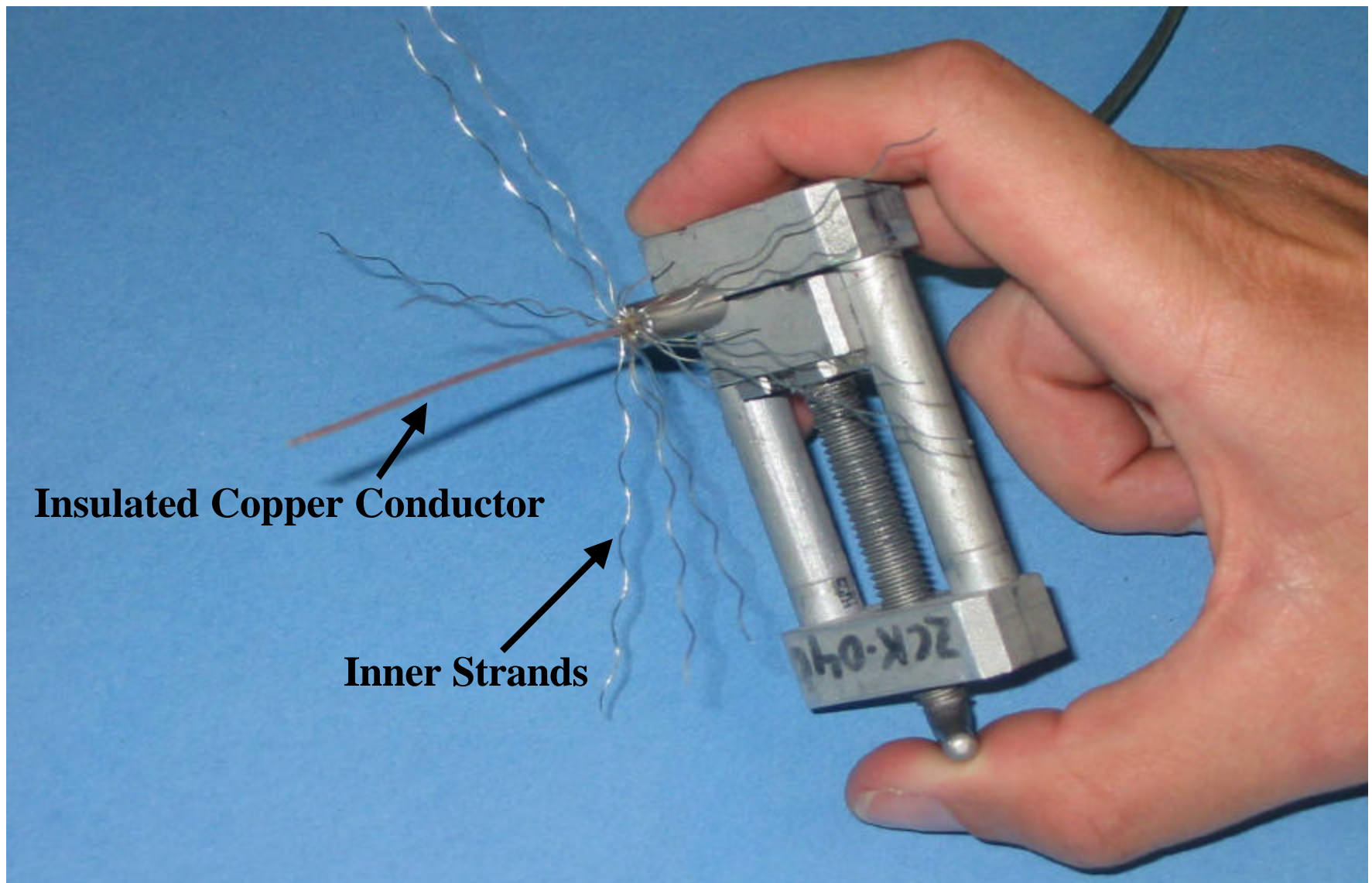

Insulated Copper Conductor

Inner Strands

**Pic.11 Unwind inner-layer strands of armor
(exposing the insulated conductor wire)**

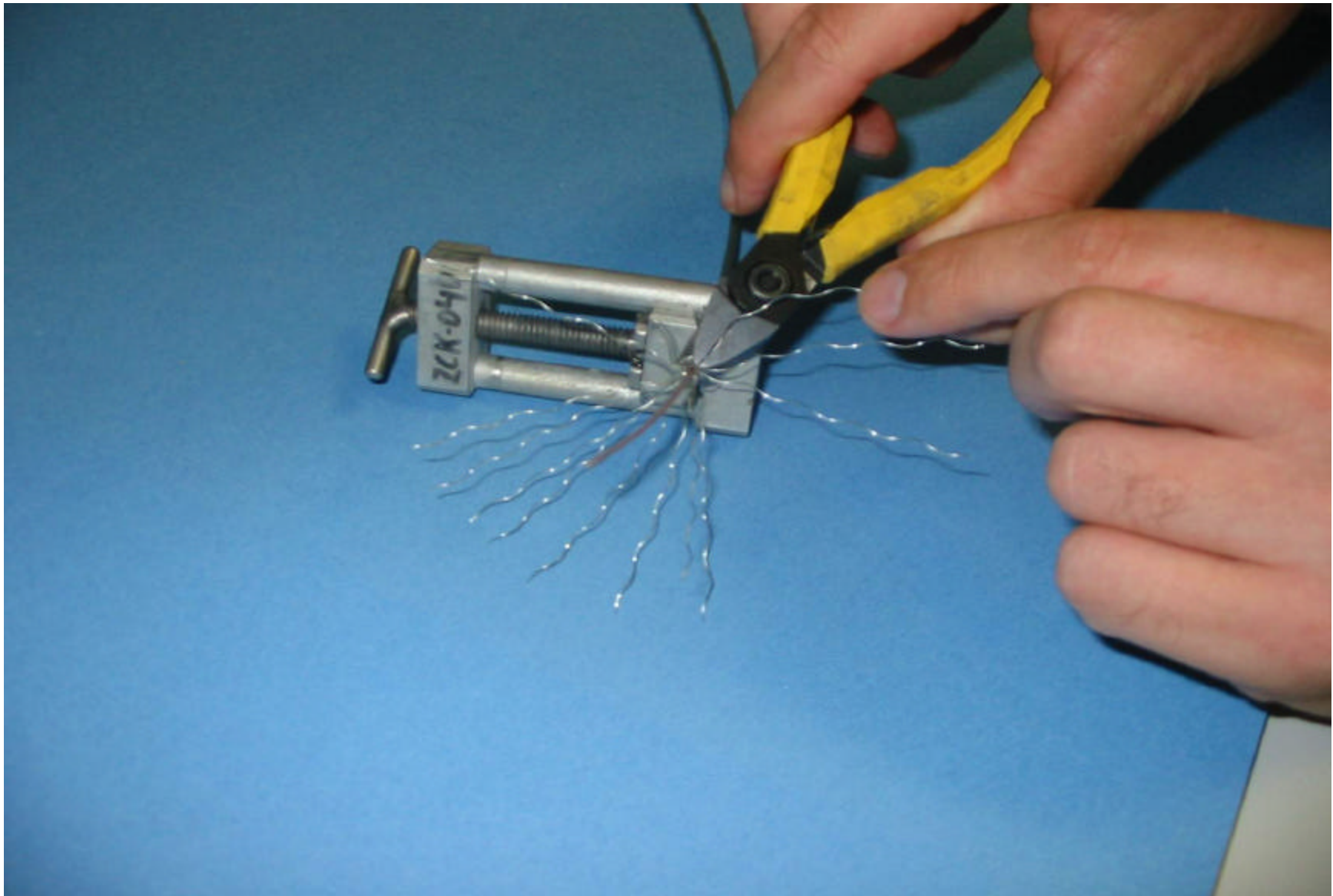

Pic.12 Clip 5 of the 12 inner armor strands close to the top of the insert

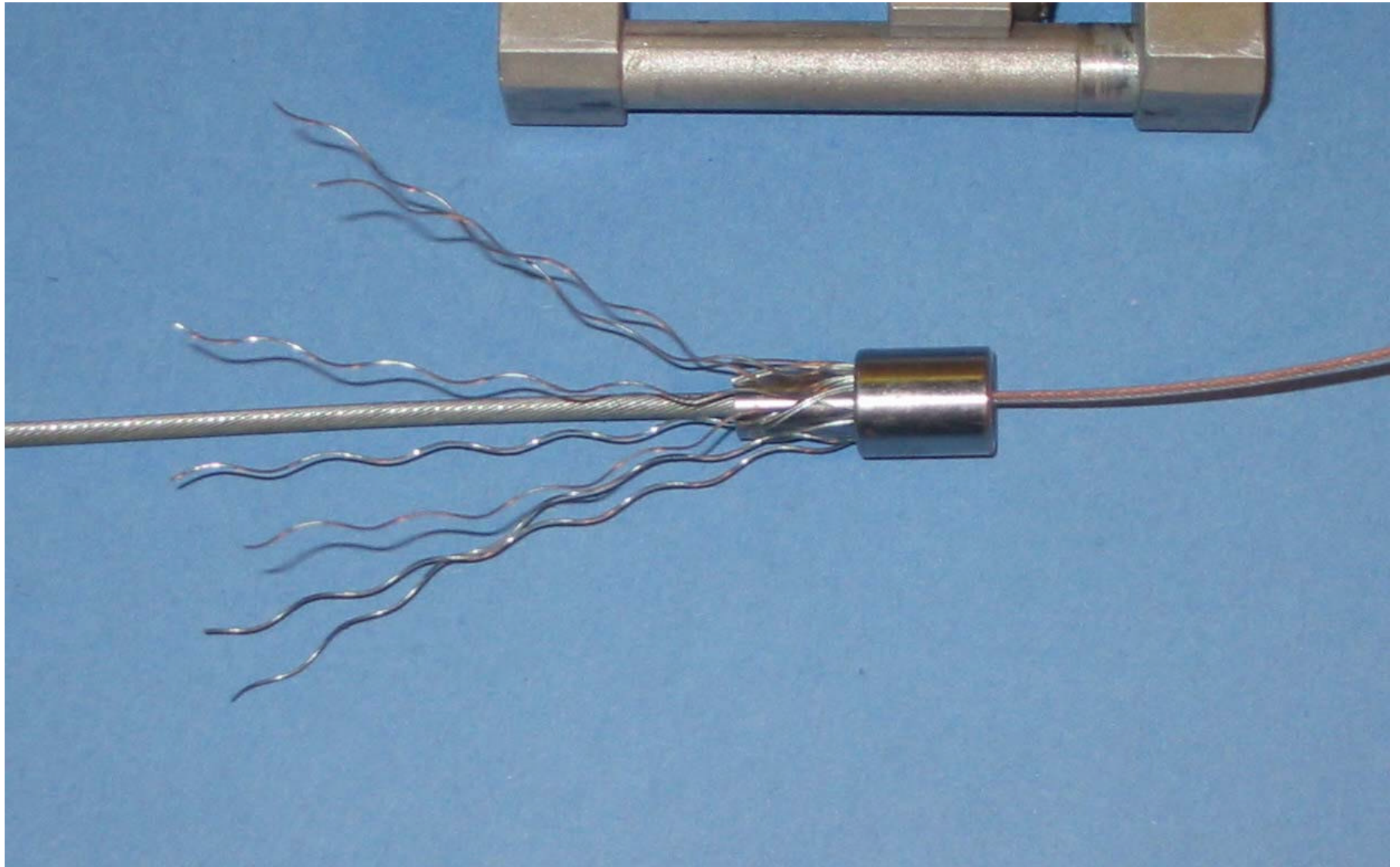

**Pic.13 Bend down Remaining Inner Wire Strands
(Use jig and termination sleeve)**

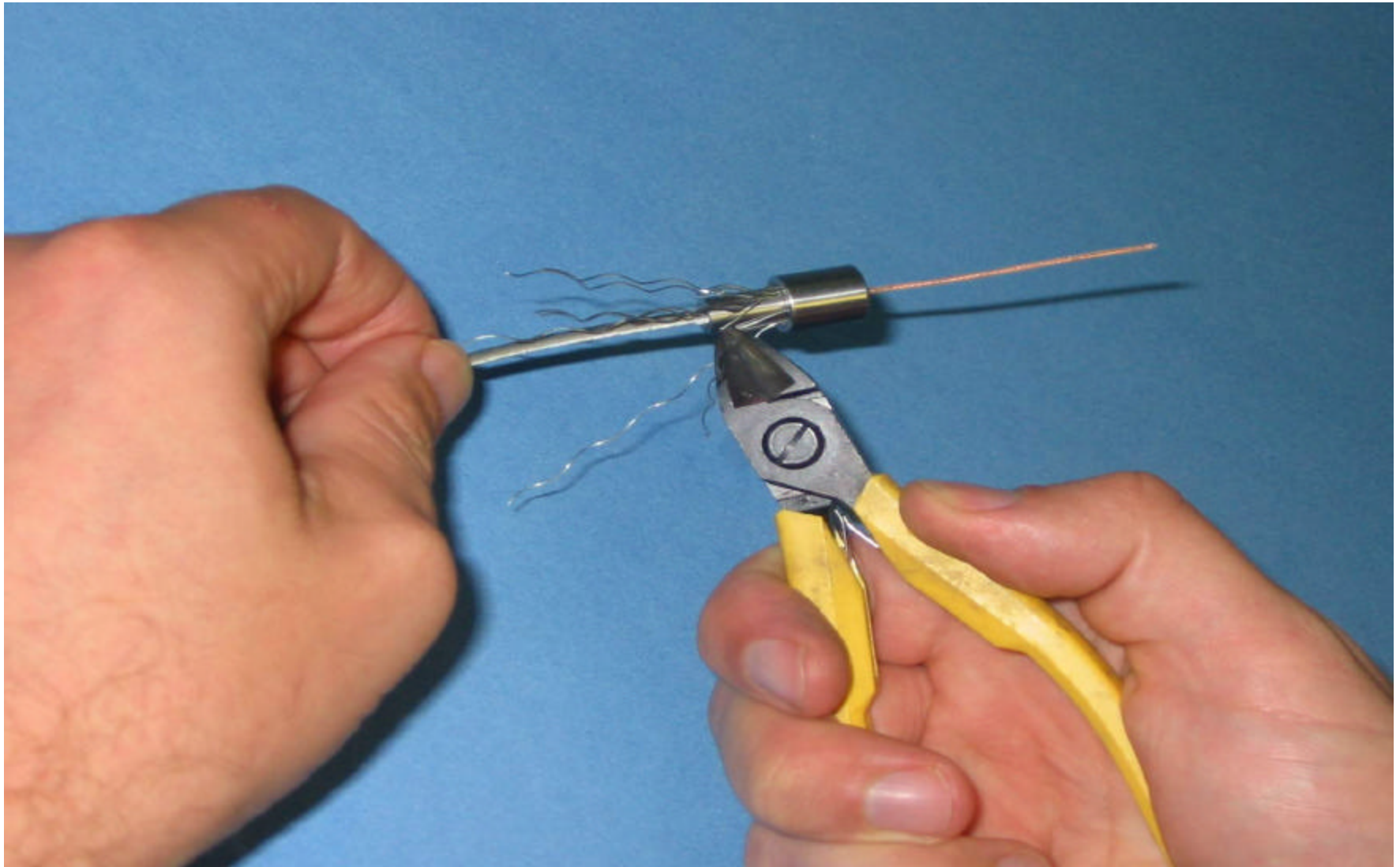

Pic.13 Trim Inner Wire Strands to Base of Insert

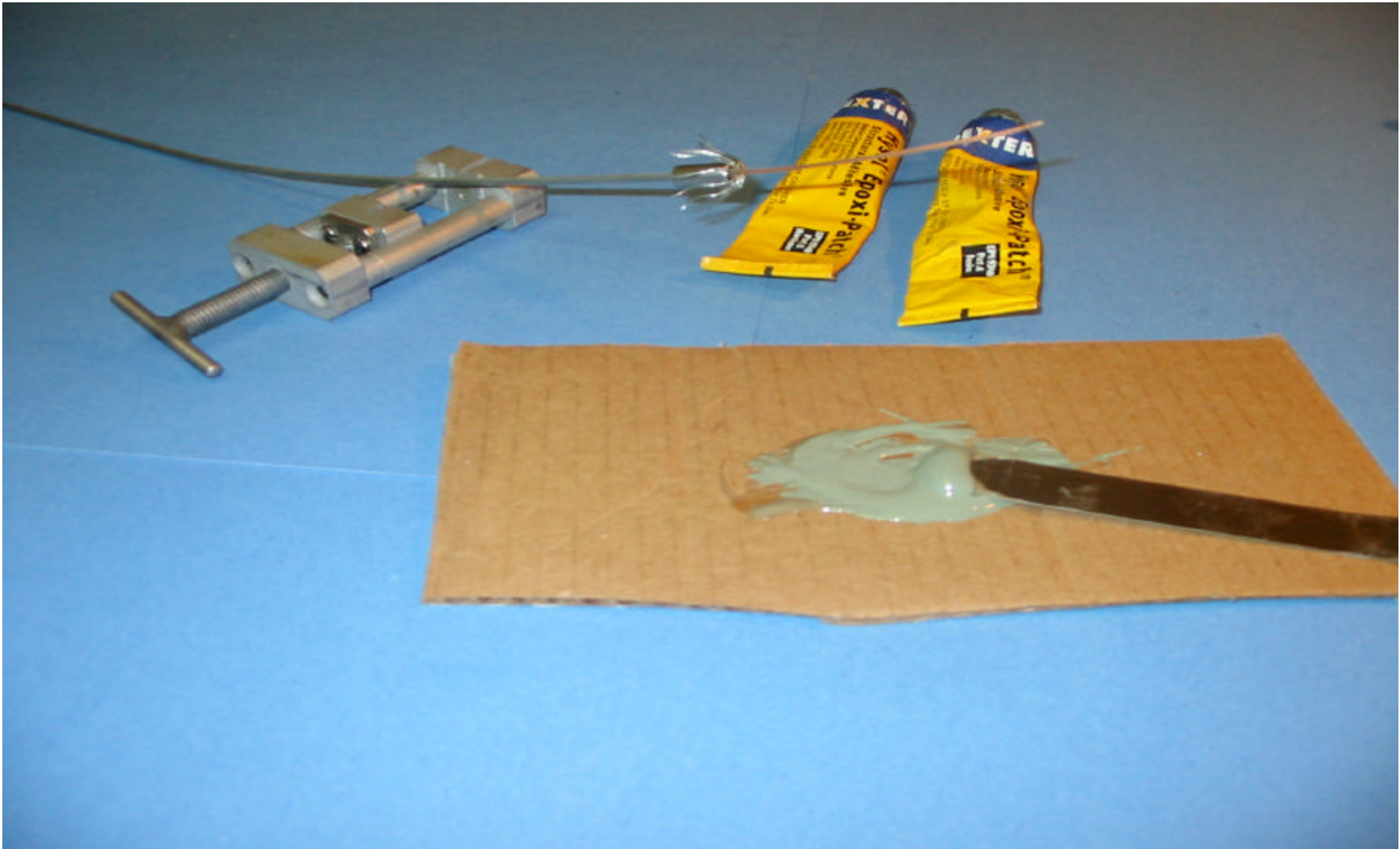

Pic.14 Mix epoxy



Pic.15 Apply epoxy. Cover the trimmed armor strands with epoxy

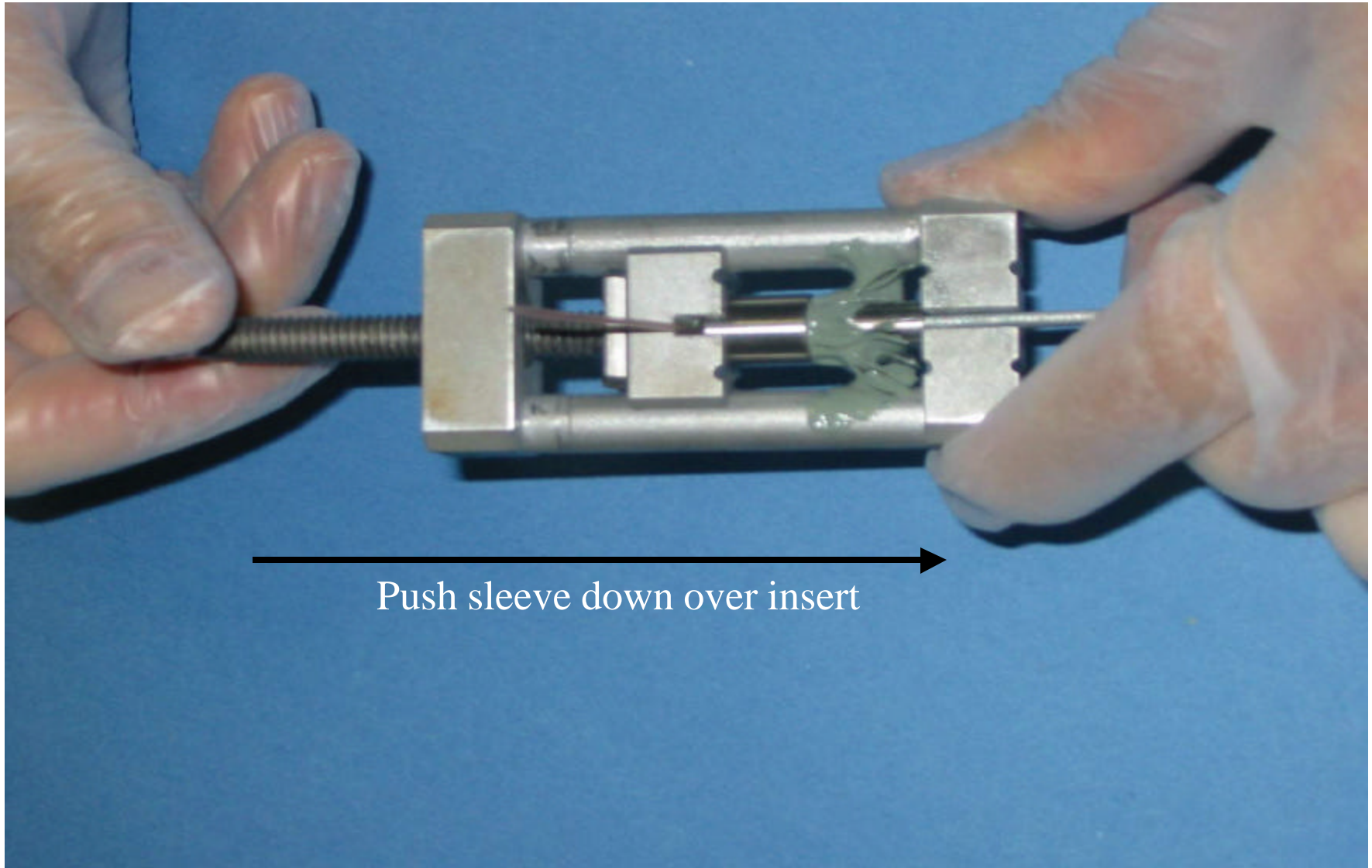

Pic.16 Using the termination jig, push the termination sleeve completely down over the insert

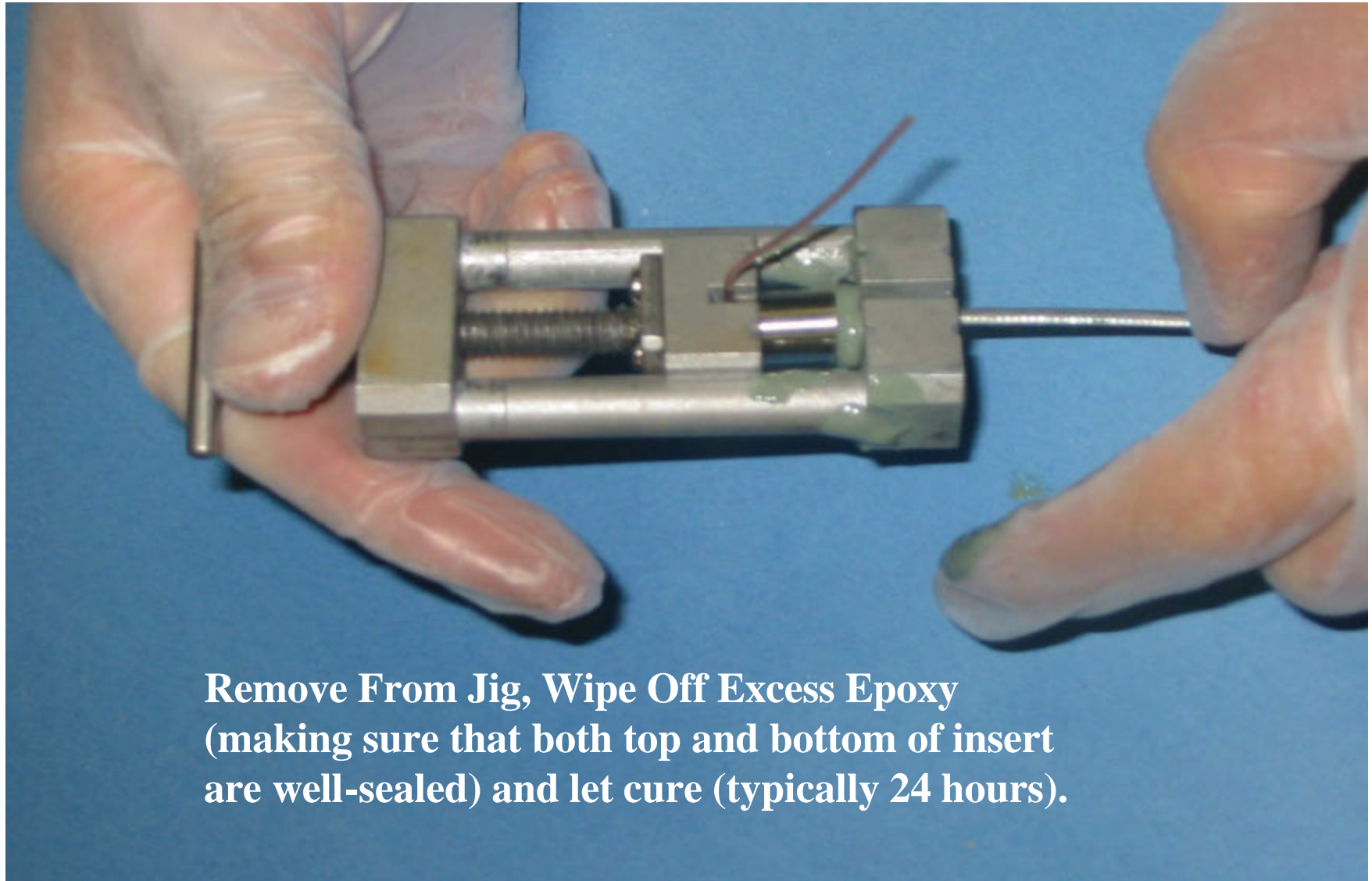

**Remove From Jig, Wipe Off Excess Epoxy
(making sure that both top and bottom of insert
are well-sealed) and let cure (typically 24 hours).**

Pic.17 Termination Sleeve completely pushed down over insert



Pic.18 Apply silicon lubricant to the insulated conductor wire

Note: Solder guide-wire to end of copper conductor wire, prior to sliding rubber boot (easier to slide boot and less chance of damaging conductor wire).

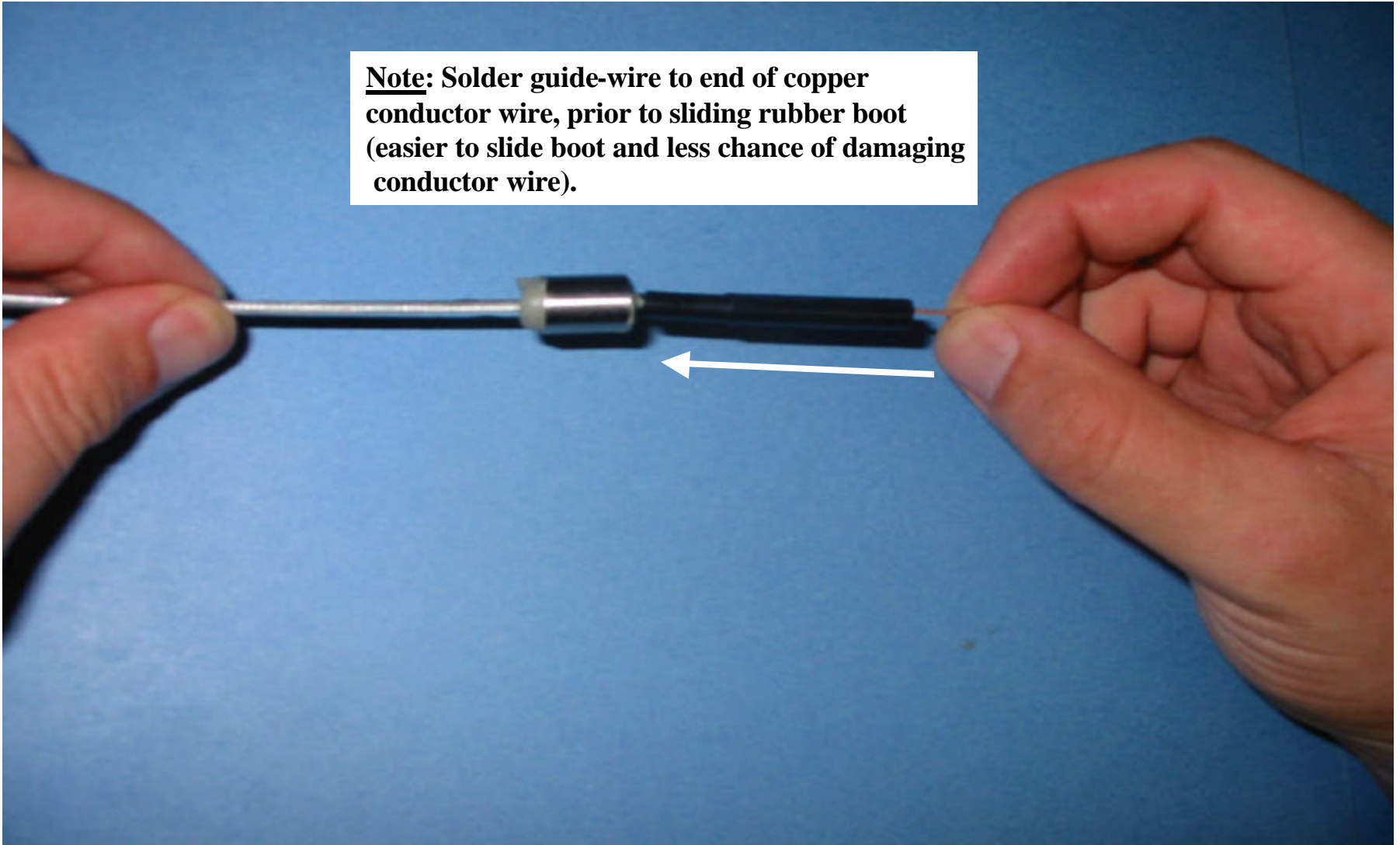

Pic.20 Slide the rubber boot towards the cablehead termination (final position)

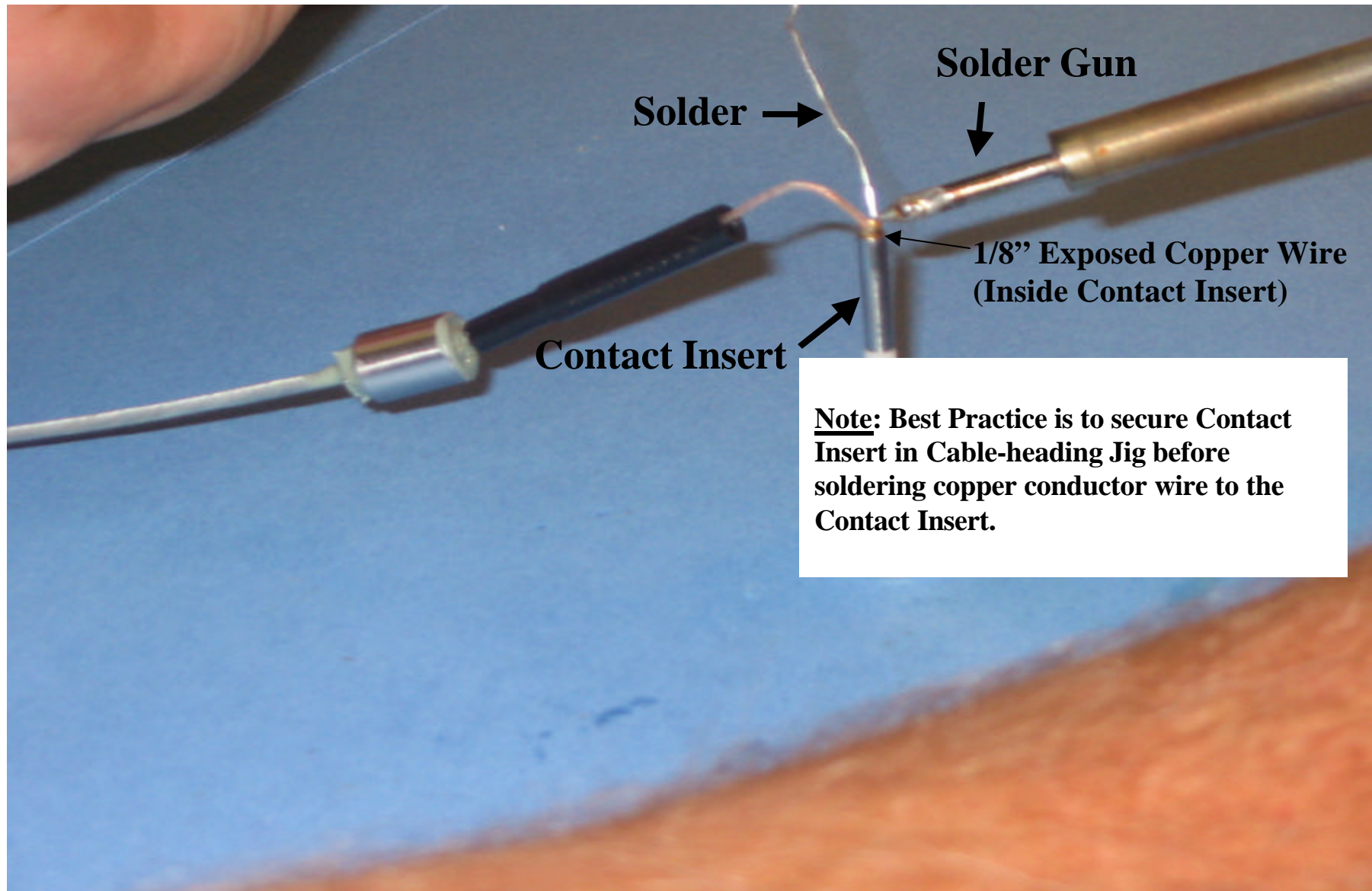

Pic.21 Solder 1/8 inch exposed copper wire (use wire strippers) into contact insert

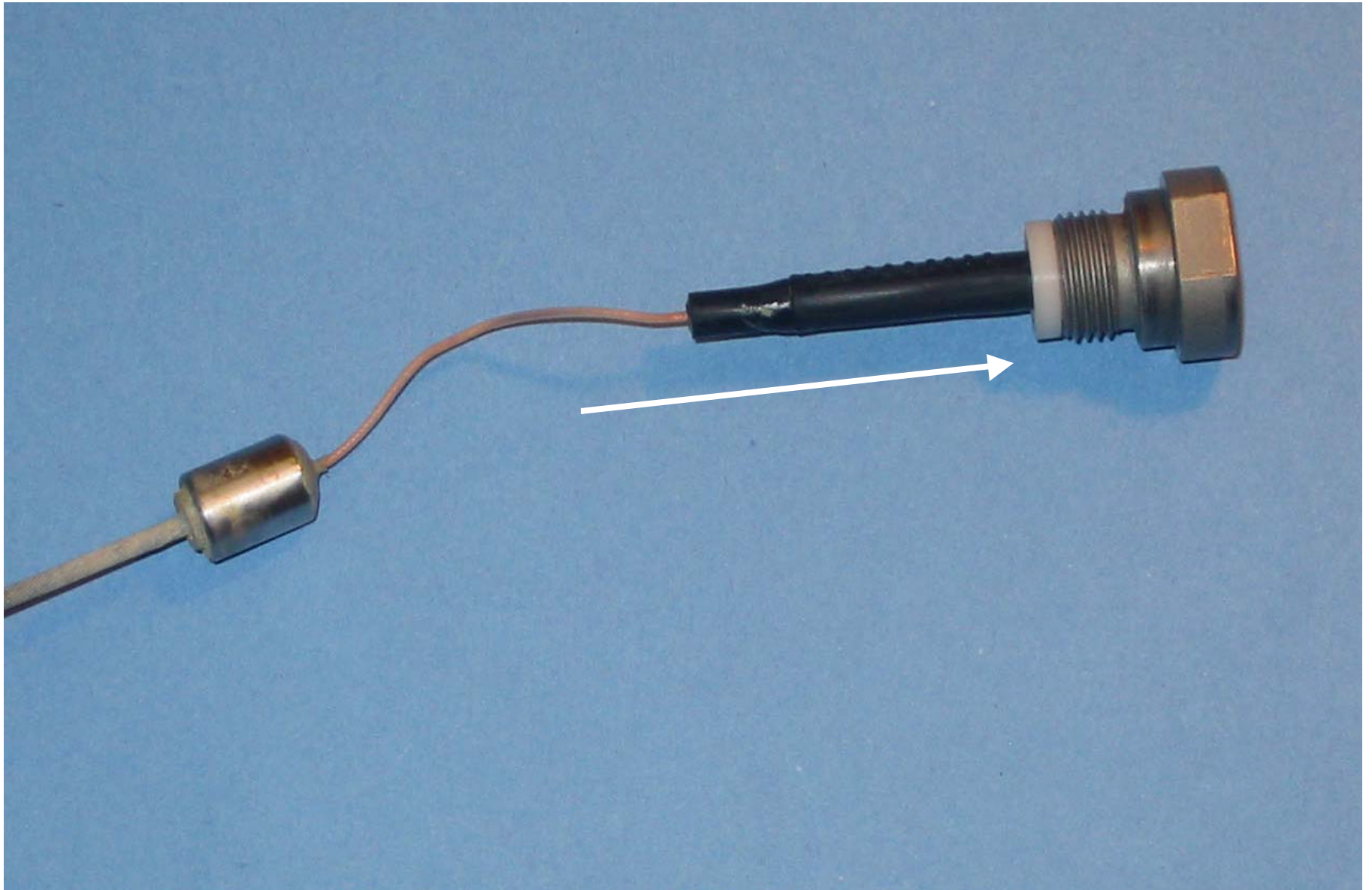

Pic.22 Slide the rubber boot down over the contact insert
(when the solder has cooled)

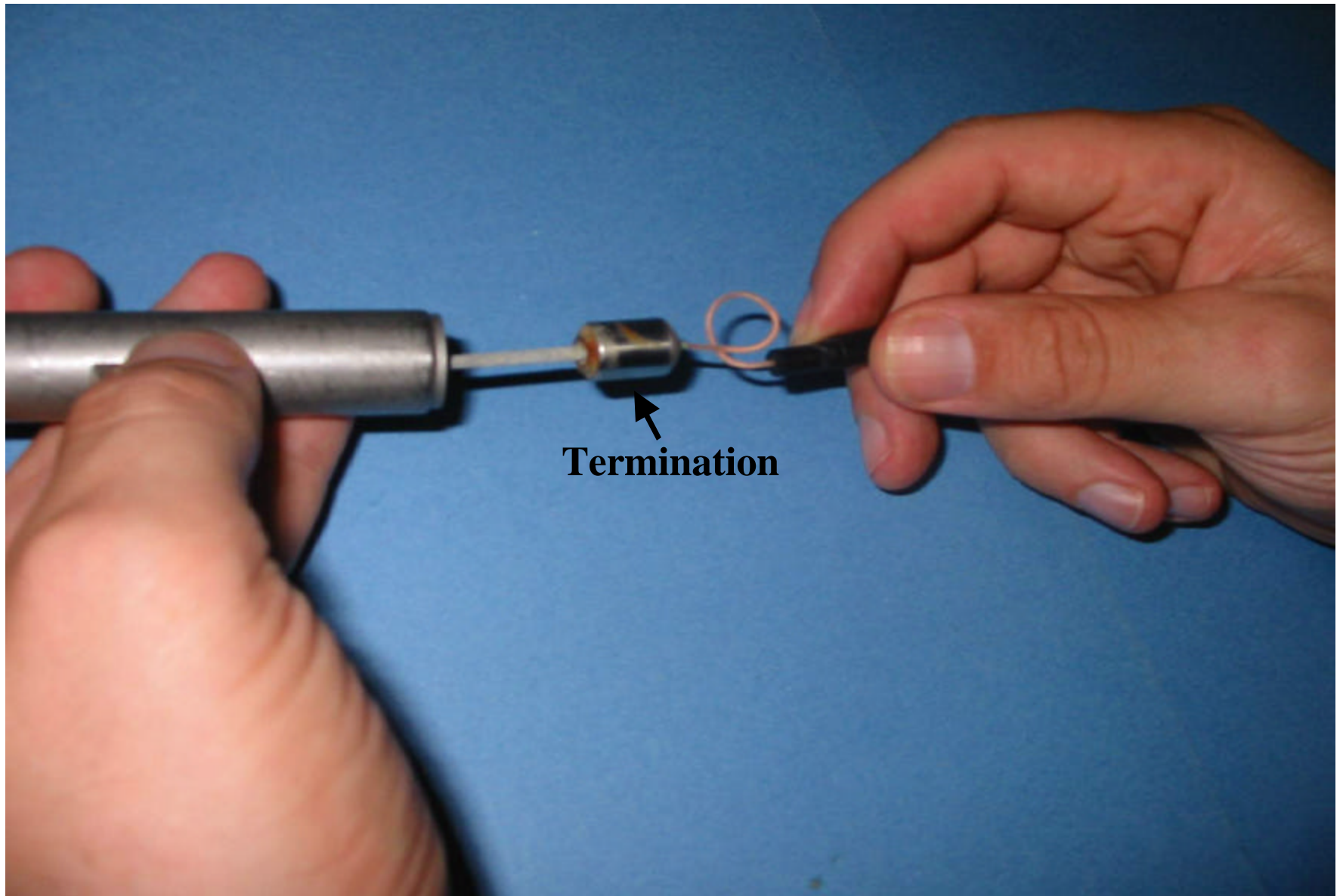

Pic.23 Create a loop in the conductor wire before sliding the cablehead housing down over the termination

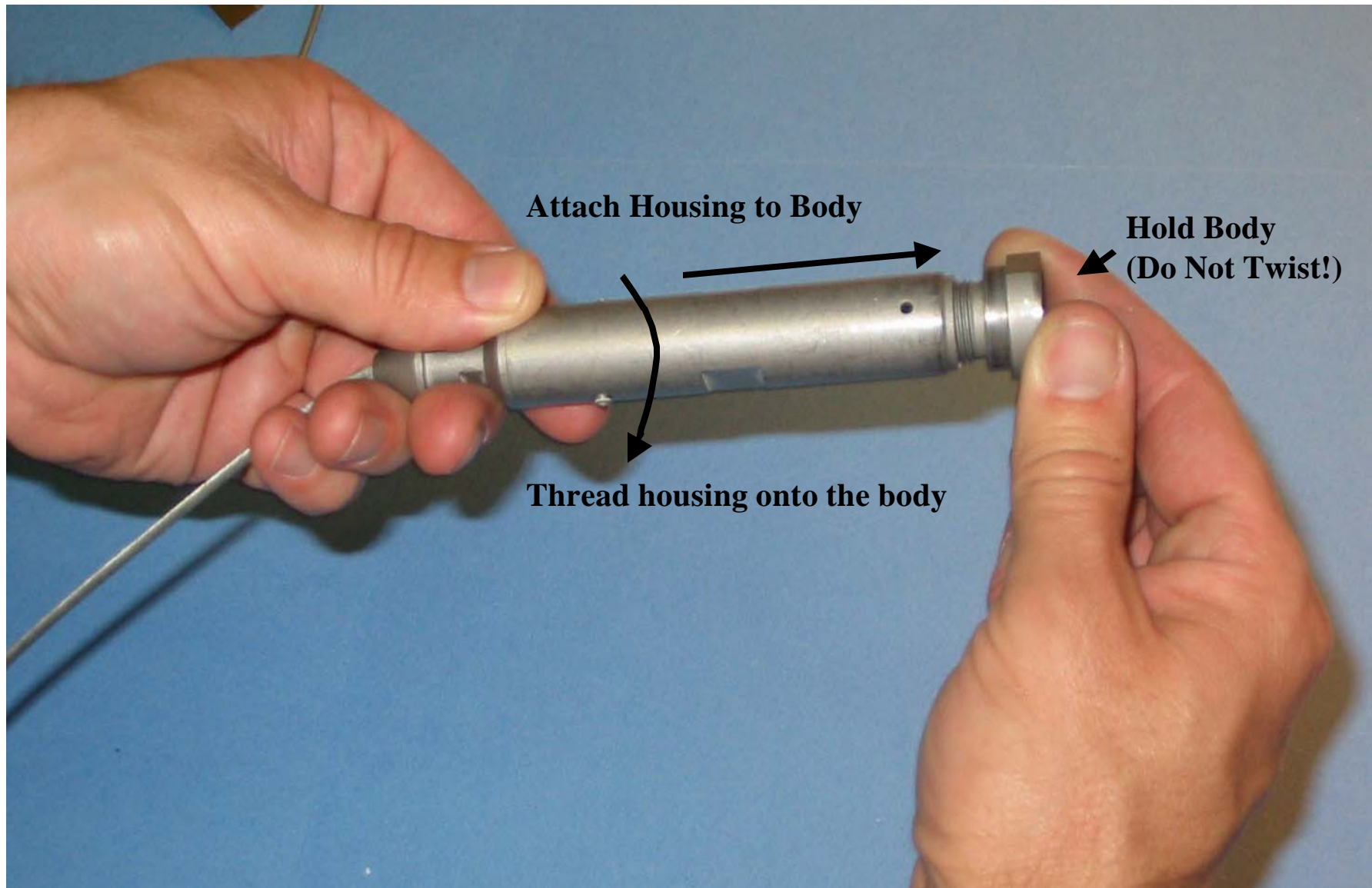

**Pic.24 Thread the cablehead housing onto the body
(Do not twist the body! –this can damage the conductor wire)**

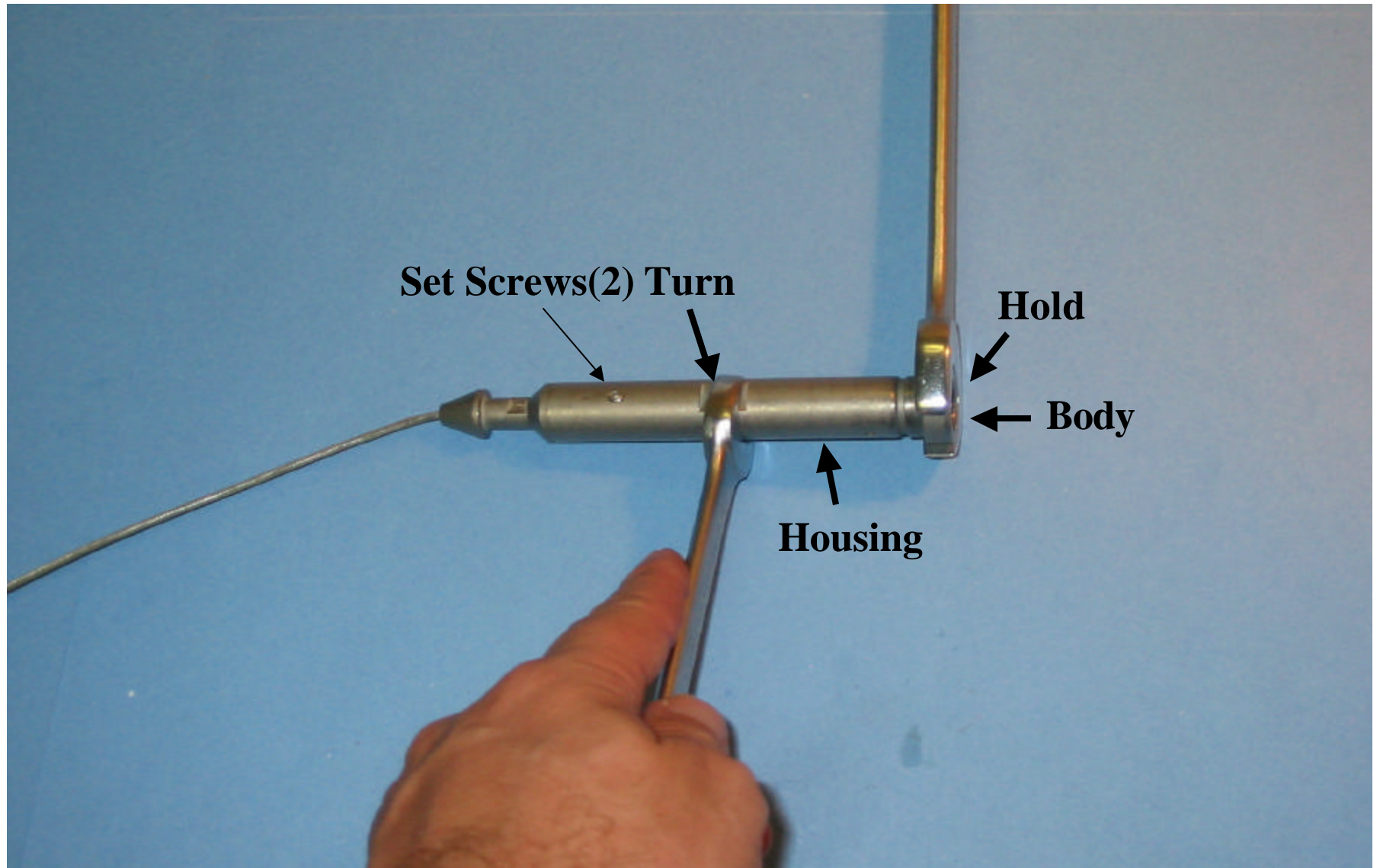

**Pic.25 Tighten the housing to the body
Tighten the set screws to complete re-assembly of the cablehead**

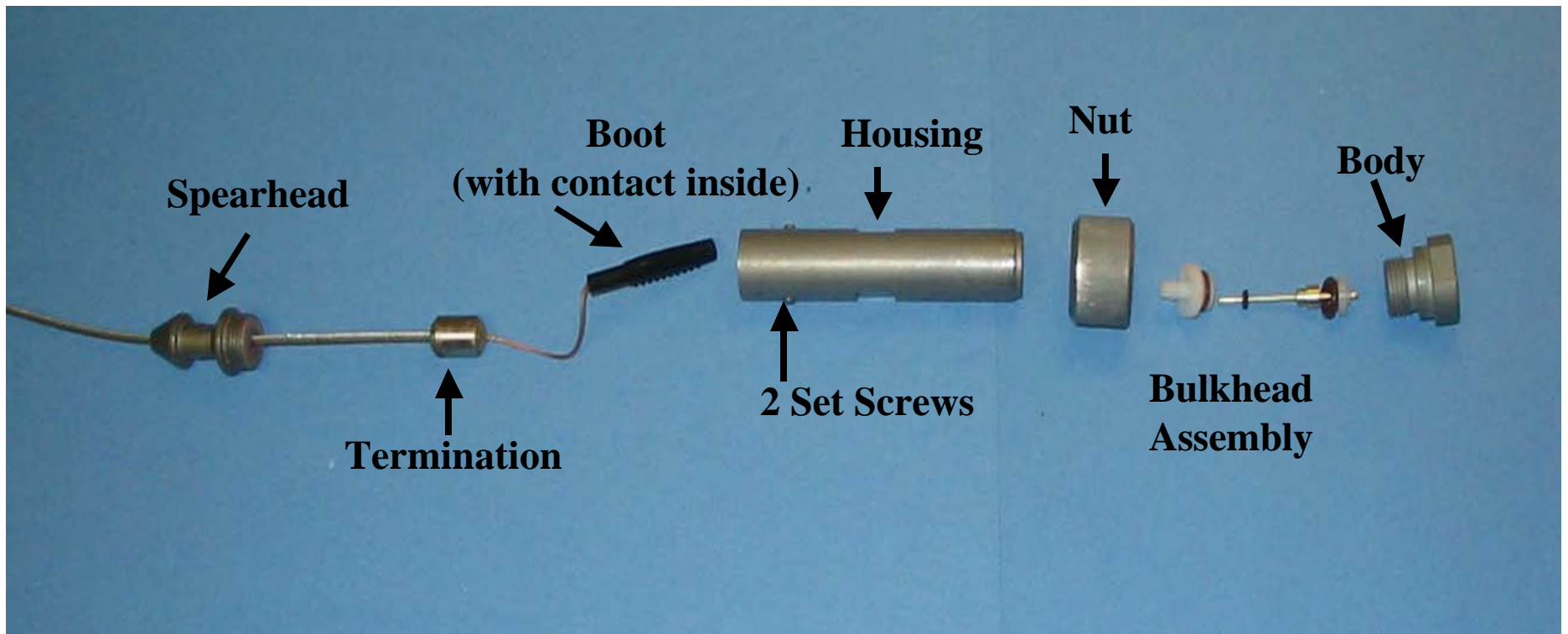

Pic.26 Exploded view of cablehead assembly

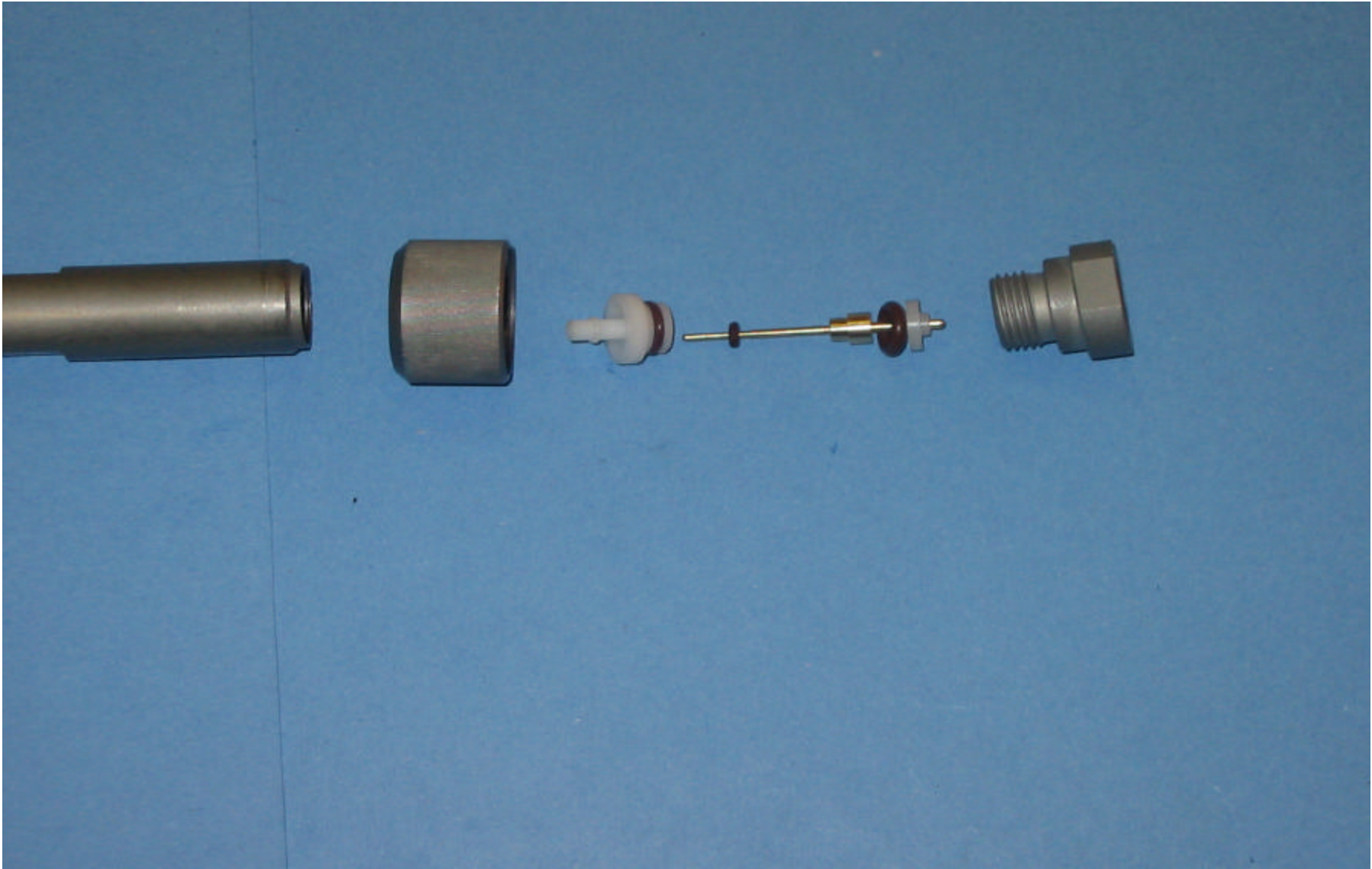

Pic.27 Exploded view of bulkhead assembly

Attachment A: Standard Operating Procedure (SOP) #2

Passive Diffusion Bag (PDB) Sampling Protocol

1.0 Obtain PDB Sampler Hardware

- The hardware for each well in the sampling program will be custom-made by the PDB manufacturer (EON Products, Inc.) or by field sampling personnel, prior to the initiation of the field program.
- Each hardware kit is labeled for each well, and should closely match the dimensions submitted to the kit manufacturer.
- Open the hardware kit bag and carefully unwind the first few feet of cable or rope, to expose the first PDB station (colored zip ties or metal clips) from which the PDB samplers will hang.

2.0 Install PDB Sampler Hardware (Page 6, USGS, 2001)

- Unseal the appropriate PDB sampler hardware kit (match label to well name) and carefully retrieve hardware.
- Clip the first (bottom) PDB sampler onto the top and bottom PDB station using the available zip ties.
- Record time and bag position in the well.
- If this well is to be profiled, continue attaching PDB samplers to remaining PDB stations for this monitoring well.
- Otherwise, if this well is not scheduled to be profiled and has not yet been profiled, continue unwinding the hardware kit until the uppermost set of plastic disks is exposed and then attach the second PDB sampler.
- Once a well has been profiled and a specific depth has been selected from which to monitor groundwater quality, only one PDB sampler will be installed on the hardware kit – the depth interval will be noted on the field instruction form.
- Once the necessary PDB samplers have been installed, carefully lower the hardware kit until the stainless steel weight touches the well bottom.
- Confirm that the top clip (marker) roughly equals the top of casing and adjust as necessary to ensure a snug fit (slightly taught line) when the well cap is closed.
- Attach the end of the hardware line to the well head hanging device – make sure that the PDB sampler kit does not sag when well cap is closed.
- Secure the well.

3.0 Sample Naming/Recording

- Sample numbers will be generated as specified in the QAPP.
- Field personnel must include a depth for each sampler on the chain-of-custody.

- Record the relative position of each bag – they will be numbered in the order they will be retrieved (i.e., top → #1... #2... #n... → bottom) – in other words, the first PDB sampler to be installed will have the highest number and the last PDB sampler will have the lowest number.

4.0 PDB Sampler Retrieval (Page 9, USGS, 2001)

- Collect the appropriate number of VOA vials for the required number of VOC samples.
- Measure and record the corrected depth to water from the top of casing to ensure PDB are completely submerged below the water level.
- Note the time and begin reeling the PDB sampler hardware line.
- Field personnel must include a depth for each sampler on the chain-of-custody in the form of station number as recorded during bag placement.
- Important - the contents of each bag must be transferred to the VOA vials immediately after PDBs are removed from the well and before addressing any other sampling-related issues to avoid losing volatile compounds to atmosphere. Once the first bag leaves the water, the time limit starts at the same time for all exposed bags. All samples shall be contained in the VOA vials within 15 minutes of the PDB leaving the water.
- Extract the PDB sampler(s) from the well, remove the sampler cap and carefully empty the contents into VOA vials (preferably set up in a bottle holder), taking care not to over agitate the bag or water.
- Apply completed label to each VOA vial to ensure that they are not confused later.
- Repeat until all PDB samplers have been removed and contents transferred.
- QC duplicate samples consist of two separate sets of VOA vials filled from the same diffusion sampler.
- Store all filled VOA vials in Ziploc bags inside a properly cooled container.
- Follow above guidelines to re-install new PDB samplers as scheduled (profile or single-bag scenario).
- Dispose of all used passive diffusion sample bags and components appropriately as either IDW or recyclable material.
- Decontaminate all reusable equipment with clean water and ALCONOX.

5.0 User's Guide for Polyethylene-based Passive Diffusion Bag Samplers to Obtain Volatile Organic Compound Concentrations in Wells

(See following pages)

USER'S GUIDE FOR POLYETHYLENE-BASED PASSIVE DIFFUSION BAG SAMPLERS TO OBTAIN VOLATILE ORGANIC COMPOUND CONCENTRATIONS IN WELLS

PART 1: DEPLOYMENT, RECOVERY, DATA INTERPRETATION, AND QUALITY CONTROL AND ASSURANCE

Water-Resources Investigations Report 01-4060

Prepared in cooperation with the

U.S. AIR FORCE

U.S. NAVAL FACILITIES ENGINEERING COMMAND

U.S. ENVIRONMENTAL PROTECTION AGENCY

FEDERAL REMEDIATION TECHNOLOGIES ROUNDTABLE

DEFENSE LOGISTICS AGENCY

U.S. ARMY CORPS OF ENGINEERS and

INTERSTATE TECHNOLOGY AND REGULATORY COOPERATION WORK GROUP

Acknowledgments

Technical Advisory Board



U.S. Air Force Base Conversion Agency (AFBCA)
U.S. Air Force Center For Environmental Excellence (AFCEE)
Maj. Jeff Cornell (AFCEE)
Mario Ierardi (AFBCA)
Dr. Javier Santillan (AFCEE)



Defense Logistics Agency (DLA)
Lt. Col. Daniel L. Welch

U.S. Environmental Protection Agency (EPA)
Steve Schmelling, Office of Research and Development (ORD)
Dick Willey, EPA Region 1
Kathy Davies, EPA Region 3
Richard Steimle, Technology Innovation Office (TIO)



U.S. Naval Facilities Engineering Command (NAVFAC)
Cliff C. Casey (Southern Division)
Dennis Howe (Engineering Service Center)
Richard G. Mach, Jr. (Southwest Division)
Nick Ta (Engineering Service Center)



**US Army Corps
of Engineers®**

U.S. Army Corps of Engineers (USACE)
Johnette Shockley

Federal Remediation Technologies Roundtable



Interstate Technology and Regulatory Cooperation Work Group (ITRC)
George H. Nicholas (New Jersey) Team Lead
Paul M. Bergstrand (South Carolina)
Chris A. Guerre (California)
David Randolph (Tennessee)

Funding for this Guide was provided by the U.S. AIR FORCE and NAVFAC (Southern and Southwest Divisions). Additionally, the following persons are recognized for their leadership and support to this project: Marty Faile, Joe Dunkle, Kay Wishkaemper, Vince Malott, and the Passive Diffusion Bag Sampler (PDBS) Work Group.

User's Guide for Polyethylene-Based Passive Diffusion Bag Samplers to Obtain Volatile Organic Compound Concentrations in Wells

Part 1: Deployment, Recovery, Data Interpretation, and Quality Control and Assurance

By Don A. Vroblesky

U.S. Geological Survey

Water-Resources Investigations Report 01-4060

Prepared in cooperation with the

U.S. AIR FORCE

U.S. NAVAL FACILITIES ENGINEERING COMMAND

U.S. ENVIRONMENTAL PROTECTION AGENCY

FEDERAL REMEDIATION TECHNOLOGIES ROUNDTABLE

DEFENSE LOGISTICS AGENCY

U.S. ARMY CORPS OF ENGINEERS and

INTERSTATE TECHNOLOGY AND REGULATORY COOPERATION WORK GROUP



Columbia, South Carolina
2001

U.S. DEPARTMENT OF THE INTERIOR
GALE A. NORTON, Secretary

U.S. GEOLOGICAL SURVEY
Charles G. Groat, Director

Use of trade, product, or firm names in this publication is for descriptive purposes only and does not imply endorsement by the U.S. Geological Survey.

Copies of this report can be
obtained from:

U.S. Environmental Protection Agency
(USEPA)/National Service Center for
Environmental Publications (NSCEP)
Box 42419
Cincinnati, OH 45242-0419

and

U.S. Geological Survey
Branch of Information Services
Box 25286
Denver, CO 80225
Phone: 888-ASK-USGS

For additional information,
write to:

District Chief
U.S. Geological Survey
Stephenson Center–Suite 129
720 Gracern Road
Columbia, SC 29210-7651

Additional information about water
resources in South Carolina is
available on the World Wide Web
at <http://sc.water.usgs.gov>

Report can be downloaded from <http://www.itrcweb.org> and <http://www.frtr.gov>

CONTENTS

Executive Summary	1
Introduction	3
Summary of Passive Diffusion Bag Sampler Advantages and Limitations	5
Advantages	5
Limitations.....	5
Passive Diffusion Bag Sampler Deployment	6
Passive Diffusion Bag Sampler and Sample Recovery.....	9
Determining Applicability of Passive Diffusion Bag Samplers and Interpretation of Data	11
Influences of Hydraulic and Chemical Heterogeneity on Sample Quality in Long-Screened Wells.....	12
Comparison of Passive Diffusion Bag Sampling Methodology to Conventional Methodologies	12
Quality Control and Assurance	14
Summary	14
References	16

Figures

1. Photo showing typical water-filled passive diffusion bag samplers used in wells, including diffusion bag with polyethylene mesh, diffusion bag without mesh, and bag and mesh attached to bailer bottom	4
2. Photo showing example of multiple passive diffusion bag samplers prepared for deployment	8

Table

1. Compounds tested under laboratory conditions for use with passive diffusion bag samplers.....	4
--	---

Conversion Factors, Vertical Datum, Acronyms, and Abbreviations

Multiply	By	To obtain
<i>Length</i>		
inch (in.)	25.4	millimeter
foot (ft)	0.3048	meter
mile (mi)	1.609	kilometer
<i>Area</i>		
square mile (mi ²)	2.590	square kilometer
<i>Flow</i>		
foot per day (ft/d)	0.3048	meter per day
foot squared per day (ft ² /d)	0.09294	meter squared per day
gallon per minute (gal/min)	0.06308	liter per second
gallon per day (gal/d)	0.003785	cubic meter per day
inch per year (in/yr)	25.4	millimeter per year
<i>Volume</i>		
gallon (gal)	3.785	liter

Temperature is given in degrees Celsius (°C), which can be converted to degrees Fahrenheit (°F) by the following equation: °F = 9/5 (°C) + 32

Sea level refers to the National Geodetic Vertical Datum of 1929 (NGVD of 1929)—a geodetic datum derived from a general adjustment of the first-order level nets of the United States and Canada, formerly called Sea Level Datum of 1929.

Chemical concentration in water is expressed in metric units as milligrams per liter (mg/L) or micrograms per liter (µg/L).

Additional Abbreviations	
EDB	1,2-Dibromomethane
AFCEE	Air Force Center for Environmental Excellence
cDCE	<i>cis</i> -1,2-Dibromoethene
ft ³ /d	cubic feet per day
ft ³ /mg	cubic feet per milligram
°C	degrees Celsius
g	gram
ITRC	Interstate Technology Regulatory Cooperation
LDPE	low-density polyethylene
L	liter
µg	microgram
µm	micrometer
µL	microliter
mg	milligram
mL	milliliter
mL/min	milliliter per minute
MTBE	Methyl- <i>tert</i> -butyl ether
NAVFAC	Naval Facilities Engineering Command
NAPL	non-aqueous phase liquid
PDB	passive diffusion bag
PCE	Tetrachloroethene
TCE	Trichloroethene
USEPA	U.S. Environmental Protection Agency
USGS	U.S. Geological Survey
VOA	Volatile organic analysis
VOC	Volatile organic compound

User's Guide for Polyethylene-Based Passive Diffusion Bag Samplers to Obtain Volatile Organic Compound Concentrations in Wells

Part 1: Deployment, Recovery, Data Interpretation, and Quality Control and Assurance

By Don A. Vroblesky

EXECUTIVE SUMMARY

Water-filled passive diffusion bag (PDB) samplers described in this report are suitable for obtaining concentrations of a variety of volatile organic compounds (VOCs) in ground water at monitoring wells. The suggested application of the method is for long-term monitoring of VOCs in ground-water wells at well-characterized sites.

The effectiveness of the use of a single PDB sampler in a well is dependent on the assumption that there is horizontal flow through the well screen and that the quality of the water is representative of the ground water in the aquifer directly adjacent to the screen. If there are vertical components of intra-bore-hole flow, multiple intervals of the formation contributing to flow, or varying concentrations of VOCs vertically within the screened or open interval, then a multiple deployment of PDB samplers within a well may be more appropriate for sampling the well.

A typical PDB sampler consists of a low-density polyethylene (LDPE) lay-flat tube closed at both ends and containing deionized water. The sampler is positioned at the target horizon of the well by attachment to a weighted line or fixed pipe.

The amount of time that the sampler should be left in the well prior to recovery depends on the time required by the PDB sampler to equilibrate with ambient water and the time required for the environmental disturbance caused by sampler deployment to return to ambient conditions. The rate that the water within the PDB sampler equilibrates with ambient water depends on multiple factors, including the type of compound being sampled and the water temperature. The concentrations of benzene, *cis*-1,2-dichloroethene,

tetrachlorethene, trichloroethene, toluene, naphthalene, 1,2-dibromoethane, and total xylenes within the PDB samplers equilibrated with the concentrations in an aqueous mixture of those compounds surrounding the samplers under laboratory conditions within approximately 48 hours at 21 degrees Celsius (°C). A subsequent laboratory study of mixed VOCs at 10 °C showed that tetrachloroethene and trichloroethene were equilibrated by about 52 hours, but other compounds required longer equilibration times. Chloroethane, *cis*-1,2-dichloroethene, *trans*-1,2-dichloroethene, and 1,1-dichloroethene were not equilibrated at 52 hours, but appeared to be equilibrated by the next sampling point at 93 hours. Vinyl chloride, 1,1,1-trichloroethane, 1,2-dichloroethane, and 1,1-dichloroethane were not equilibrated at 93 hours, but were equilibrated by the next sampling point at 166 hours. Different equilibration times may exist for other compounds. Differences in equilibration times, if any, between single-solute or mixed VOC solutions have not yet been thoroughly examined.

The samplers should be left in place long enough for the well water, contaminant distribution, and flow dynamics to restabilize following sampler deployment. Laboratory and field data suggest that 2 weeks of equilibration probably is adequate for many applications; therefore, a minimum equilibration time of 2 weeks is suggested. In less permeable formations, longer equilibration times may be required. When applying PDB samplers in waters colder than previously tested (10 °C) or for compounds without sufficient corroborating data, a side-by-side comparison with conventional methodology is advisable to justify the field equilibration time.

Following the initial equilibration period, the samplers maintain equilibrium concentrations with the ambient water until recovery. Thus, there is no specified time for sampler recovery after initial equilibration. PDB samplers routinely have been left in ground waters having concentrations of greater than 500 parts per million (ppm) of trichloroethene for 3 months at a time with no loss of bag integrity, and at one site, the PDB samplers have been left in place in VOC-contaminated ground water for 1 year with no reported loss of sampler integrity. The effects of long-term (greater than 1 month) PDB-sampler deployment on sampler and sample integrity have not yet been thoroughly tested for a broad range of compounds and concentrations, however. Moreover, in some environments, development of a biofilm on the polyethylene may be a consequence of long-term deployment. Investigations of semipermeable membrane devices (SPMDs) have shown that the transfer of some compounds across a heavily biofouled polyethylene membrane may be reduced, but not stopped. If a heavy organic coating is observed on a PDB sampler, it is advisable to determine the integrity of the sample by comparison to a conventional sampling method before continuing to use PDB samplers for long-term deployment in that well.

Recovery consists of removing the samplers from the well and immediately transferring the enclosed water to 40-milliliter sampling vials for analysis. The resulting concentrations represent an integration of chemical changes over the most recent portion of the equilibration period (approximately 48 to 166 hours, depending on the water temperature and the type of compound).

The method has both advantages and limitations when compared to other sampling methods. Advantages include the potential for PDB samplers to eliminate or substantially reduce the amount of purge water associated with sampling. The samplers are relatively inexpensive and easy to deploy and recover. Because PDB samplers are disposable, there is no downhole equipment to be decontaminated between wells, and there is a minimum amount of field equipment required. The samplers also have the potential to delineate contaminant stratification in the formation across the open or screened intervals of monitoring wells where vertical hydraulic gradients are not present. In addition, the samplers integrate concentrations over time, which may range between about 48 to 166 hours depending on the compound of interest. Because the pore size of LDPE is only about

10 angstroms or less, sediment does not pass through the membrane into the bag. Thus, PDB samplers are not subject to interferences from turbidity. In addition, none of the data collected suggest that VOCs leach from the LDPE material, or that there is a detrimental effect on the VOC sample from the PDB material.

Water-filled polyethylene PDB samplers are not appropriate for all compounds. The samplers are not suitable for inorganic ions and have a limited applicability for non-VOCs and for some VOCs. For example, although methyl-*tert*-butyl ether and acetone and most semivolatile compounds are transmitted through the polyethylene bag, laboratory tests have shown that the resulting concentrations were lower than in ambient water. A variety of factors influence the ability of compounds to diffuse through the polyethylene. These factors include the molecular size and shape and the hydrophobic nature of the compound. Unpublished laboratory test data of semivolatile compounds in contact with PDB samplers showed a higher concentration of phthalates inside the PDB sampler than outside the PDB sampler, suggesting that the polyethylene may contribute phthalates to the enclosed water. Thus, the samplers should not be used to sample for phthalates.

VOC concentrations in PDB samplers represent concentrations in the vicinity of the sampler within the well screen or open interval. This may be a limitation for PDB samplers and some other types of sampling, such as low-flow sampling, if the ground-water contamination is above or below the screen or not in the sample intervals providing water movement to the PDB samplers. If there is a vertical hydraulic gradient in the well, then the concentrations in the sampler may represent the concentrations in the water flowing vertically past the sampler rather than in the formation directly adjacent to the sampler. Vertically spaced multiple PDB samplers may be needed in chemically stratified wells or where flow patterns through the screen change as a result of ground-water pumping or seasonal water-level fluctuations.

The purposes of this document are to present methods for PDB sampler deployment, and recovery; to discuss approaches to determine the applicability of passive diffusion samplers; and to discuss various factors influencing interpretation of the data. The intended audience for the methodology sections of this report is managers and field personnel involved in using PDB samplers. The discussion of passive diffusion sampler applicability and interpretation of the data is

suiting for project managers, technical personnel, and the regulatory community. Part 2 of this report presents case studies of PDB sampler field applications.

INTRODUCTION

The use of PDB samplers for collecting ground-water samples from wells offers a cost-effective approach to long-term monitoring of VOCs at well-characterized sites (Vroblesky and Hyde, 1997; Gefell and others, 1999). The effectiveness of the use of a single PDB sampler in a well is dependent on the assumption that there is horizontal flow through the well screen and that the quality of the water is representative of the ground water in the aquifer directly adjacent to the screen. If there are vertical components of intra-borehole flow, multiple intervals of the formation contributing to flow, or varying concentrations of VOCs vertically within the screened or open interval, then deployment of multiple PDB samplers within a well may be more appropriate for sampling the well.

The samplers consist of deionized water enclosed in a LDPE sleeve (fig. 1) and are deployed adjacent to a target horizon within a screened or open interval of a well. The suggested application is for long-term monitoring of VOCs in ground-water wells. Where the screened interval is greater than 10 feet (ft), the potential for contaminant stratification and/or intra-borehole flow within the screened interval is greater than in screened intervals shorter than 10 ft. It is important that the vertical distribution of contaminants be determined in wells having 10-ft-long well screens, and that both the vertical distribution of contaminants and the potential for intra-borehole flow be determined in wells having screens longer than 10 ft. For many VOCs of environmental interest (table 1), the VOC concentration in water within the sampler approaches the VOC concentration in water outside of the PDB sampler over an equilibration period. The resulting concentrations represent an integration of chemical changes over the most recent part of the equilibration period (approximately 48 to 166 hours, depending on the water temperature and the type of compound being sampled). The approach is inexpensive and has the potential to eliminate or substantially reduce the amount of purge water removed from the well.

A variety of PDB samplers have been utilized in well applications (fig. 1). Although the samplers vary in specific construction details, a typical PDB sampler consists of a 1- to 2-ft-long LDPE tube closed at both ends and containing laboratory-grade deionized water (fig. 1). The typical diameter for PDB samplers used in a 2-inch-diameter well is approximately 1.2 inches; however, other dimensions may be used to match the well diameter. Equilibration times may be longer for larger diameter PDB samplers. On the outside of the PDB sampler, a low-density polyethylene-mesh sometimes is used for protection against abrasion in open boreholes and as a means of attachment at the prescribed depth. The PDB sampler can be positioned at the target horizon by attachment to a weighted line or by attachment to a fixed pipe.

PDB samplers for use in wells are available commercially. Authorized distributors as of March 2001 are Columbia Analytical Services (800-695-7222; www.caslab.com) and Eon Products (800-474-2490; www.eonpro.com). A current list of vendors and PDB-sampler construction details can be obtained from the U.S. Geological Survey Technology Transfer Enterprise Office, Mail Stop 211, National Center, 12201 Sunrise Valley Drive, Reston, Virginia 20192 (telephone 703-648-4344; fax 703-648-4408). PDB samplers employ patented technology (U.S. patent number 5,804,743), and therefore, require that the user purchase commercially produced samplers from a licensed manufacturer or purchase a nonexclusive license for sampler construction from the U.S. Geological Survey Technology Enterprise Office at the above address.

The purposes of this document are to present methods for PDB sampler deployment, and recovery; to discuss approaches for determining the applicability of passive diffusion samplers; and to discuss various factors influencing interpretation of the data. The intended audience for the methodology sections of this report is managers and field personnel involved in using PDB samplers. The discussion of PDB sampler applicability and interpretation of the data is suited for project managers, technical personnel, and the regulatory community. Part 2 of this report presents case studies of PDB-sampler field applications.

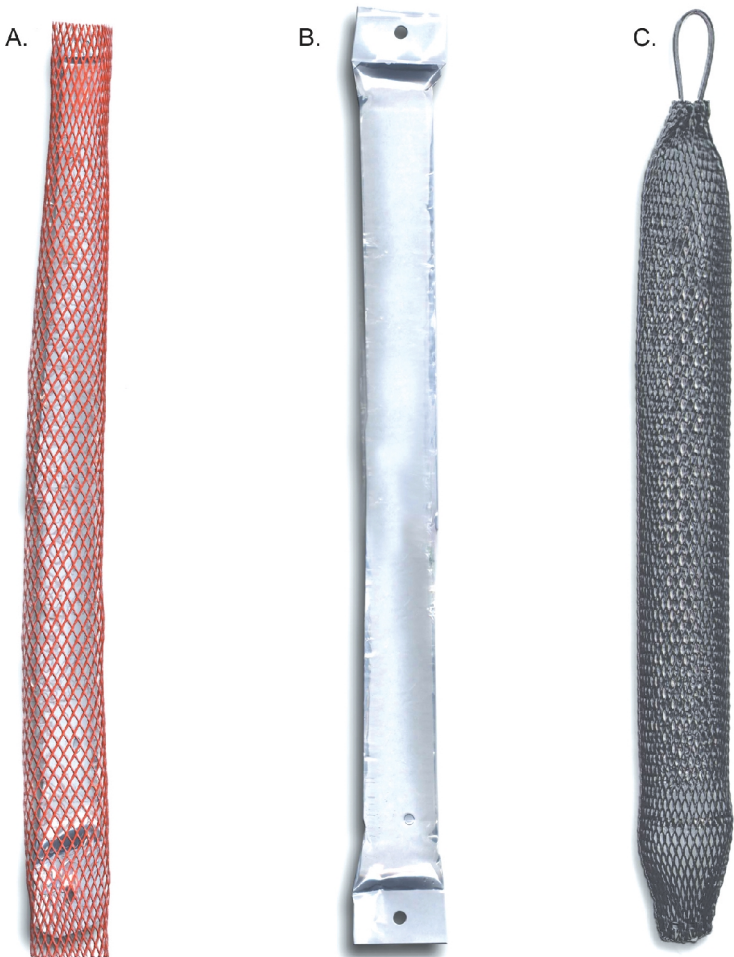

Figure 1. Typical water-filled passive diffusion bag samplers used in wells, including (A) diffusion bag with polyethylene mesh, (B) diffusion bag without mesh, and (C) bag and mesh attached to bailer bottom.

Table 1. Compounds tested under laboratory conditions for use with passive diffusion bag samplers [From Vroblesky and Campbell, 2001]

Tested compounds showing good correlation (average differences in concentration of 11 percent or less between diffusion-sampler water and test-vessel water) in laboratory tests			
Benzene	2 Chlorovinyl ether	<i>cis</i> -1,2-Dichloroethene	1,1,1-Trichloroethane
Bromodichloromethane	Dibromochloromethane	<i>trans</i> -1,2-Dichloroethene	1,1,2-Trichloroethane
Bromoform	Dibromomethane	1,2-Dichloropropane	Trichloroethene
Chlorobenzene	1,2-Dichlorobenzene	<i>cis</i> -Dichloropropene	Trichlorofluoromethane
Carbon tetrachloride	1,3-Dichlorobenzene	1,2-Dibromoethane	1,2,3-Trichloropropane
Chloroethane	1,4-Dichlorobenzene	<i>trans</i> -1,3-Dichloropropene	1,1,2,2-Tetrachloroethane
Chloroform	Dichlorodifluoromethane	Ethyl benzene	Tetrachloroethene
Chloromethane	1,2-Dichloroethane	Naphthalene	Vinyl chloride
	1,1-Dichloroethene	Toluene	Total xylenes
Tested compounds showing poor correlation (average differences in concentration greater than 20 percent between diffusion-sampler water and test-vessel water) in laboratory tests			
Acetone*	Methyl- <i>tert</i> -butyl ether	Styrene	

*T.M Sivavec and S.S. Baghel, General Electric Company, written commun., 2000

Summary of Passive Diffusion Bag Sampler Advantages and Limitations

Advantages

1. PDB samplers have the potential to eliminate or substantially reduce the amount of purge water associated with sampling.

2. PDB samplers are inexpensive.

3. The samplers are easy to deploy and recover.

4. Because PDB samplers are disposable, there is no downhole equipment to be decontaminated between wells.

5. A minimal amount of field equipment is required.

6. Sampler recovery is rapid. Because of the small amount of time and equipment required for the sampling event, the method is practical for use where access is a problem or where discretion is desirable (that is, residential communities, business districts, or busy streets where vehicle traffic control is a concern).

7. Multiple PDB samplers, distributed vertically along the screened or open interval, may be used in conjunction with borehole flow meter testing to gain insight on the movement of contaminants into and out of the well screen or open interval or to locate the zone of highest concentration in the well. Analytical costs when using multiple PDB samplers sometimes can be reduced by selecting a limited number of the samplers for laboratory analysis based on screening by using field gas chromatography at the time of sample collection.

8. Because the pore size of LDPE is only about 10 angstroms or less, sediment does not pass through the membrane into the bag. Thus, PDB samplers are not subject to interferences from turbidity. In addition, none of the data collected suggest that VOCs leach from the LDPE material or that there is a detrimental effect from the PDB material on the VOC sample.

Limitations

1. PDB samplers integrate concentrations over time. This may be a limitation if the goal of sampling is to collect a representative sample at a point in time in an aquifer where VOC-concentrations substantially change more rapidly than the samplers equilibrate. Laboratory results obtained indicate that a variety of compounds equilibrated within 48 hours at 21 °C (Vroblesky and Campbell, 2001). Vinyl chloride, 1,1,1-trichloroethane, 1,2-dichloroethane, and 1,1-dichloroethane may require between 93 and 166 hours to equilibrate at 10 °C (T.M. Sivavec and S.S. Baghel, General Electric Company, written commun., 2000). The initial equilibration under field conditions may be longer to allow

well water, contaminant distribution, and flow dynamics to restabilize following sampler deployment.

2. Water-filled polyethylene PDB samplers are not appropriate for all compounds. For example, although methyl-*tert*-butyl ether and acetone (Vroblesky, 2000; Paul Hare, General Electric Company, oral commun., 2000) and most semivolatile compounds are transmitted through the polyethylene bag, laboratory tests have shown that the resulting concentrations were lower than in ambient water. A variety of factors influence the ability of compounds to diffuse through the polyethylene membrane. These factors include the molecular size and shape and the hydrophobic nature of the compound. Compounds having a cross-sectional diameter of about 10 angstroms or larger (such as humic acids) do not pass through the polyethylene because the largest (transient) pores in polyethylene do not exceed about 10 angstroms in diameter (Flynn and Yalkowsky, 1972; Hwang and Kammermeyer, 1975; Comyn, 1985). The samplers are not appropriate for hydrophilic polar molecules, such as inorganic ions. A detailed discussion of the relation between hydrophobicity and compound transport through polyethylene can be found in Gale (1998). Unpublished laboratory test data (D.A. Vroblesky, U.S. Geological Survey, written commun., 1998) of semi-volatile compounds in contact with PDB samplers showed a higher concentration of phthalates inside the PDB sampler than outside the PDB sampler, suggesting that the polyethylene may contribute phthalates to the enclosed water. Thus, the samplers should not be used to sample for phthalates.

3. PDB samplers rely on the free movement of water through the well screen. In situations where ground water flows horizontally through the well screen, the VOC concentrations in the open interval of the well probably are representative of the aquifer water in the adjacent formation (Gillham and others, 1985; Robin and Gillham, 1987; Kearl and others, 1992; Powell and Puls, 1993; Vroblesky and Hyde, 1997). In these situations, the VOC concentration of the water in contact with the PDB samplers, and therefore, the water within the diffusion samplers, probably represents local conditions in the adjacent aquifer. However, if the well screen is less permeable than the aquifer or the sandpack, then under ambient conditions, flowlines may be diverted around the screen. Such a situation may arise from inadequate well development or from iron bacterial fouling of the well screen. In this case, the VOC concentrations in the PDB samplers may not represent concentrations in

the formation water because of inadequate exchange across the well screen. PDB samplers have not yet been adequately tested to determine their response under such conditions.

4. VOC concentrations in PDB samplers represent ground-water concentrations in the vicinity of the screened or open well interval that move to the sampler under ambient flow conditions. This is a limitation if the ground-water contamination lies above or below the well screen or open interval, and requires the operation of a pump to conduct contaminants into the well for sampling.

5. In cases where the well screen or open interval transects zones of differing hydraulic head and variable contaminant concentrations, VOC concentrations obtained using a PDB sampler may not reflect the concentrations in the aquifer directly adjacent to the sampler because of vertical transport in the well. However, a vertical array of PDB samplers, used in conjunction with borehole flow meter testing, can provide insight on the movement of contaminants into or out of the well. This information then can be used to help determine if the use of PDB samplers is appropriate for the well, and to select the optimal vertical location(s) for the sampler deployment.

6. In wells with screens or open intervals with stratified chemical concentrations, the use of a single PDB sampler set at an arbitrary (by convention) depth may not provide accurate concentration values for the most contaminated zone. However, multiple PDB samplers distributed vertically along the screened or open interval, in conjunction with pump sampling (as appropriate), can be used to locate zone(s) of highest concentration in the well. Multiple PDB samplers also may be needed to track the zone of maximum concentration in wells where flow patterns through the screened interval change as a result of ground-water pumping or seasonal water-table fluctuations.

PASSIVE DIFFUSION BAG SAMPLER DEPLOYMENT

A variety of approaches can be used to deploy the PDB samplers in wells. A typical deployment approach, described in this section, is to attach the PDB samplers to a weighted line. It also is acceptable to attach the weights directly to the PDB sampler if the attachment point is of sufficient strength to support the weight. The weights attached to the bottom of the

line are stainless steel and can be reused, but must be thoroughly decontaminated with a detergent before the first use or before using in a different well. Rope, such as 90 pound, 3/16 inch braided polyester, can be used as the line for single-use applications if it is of sufficient strength to support the weight and sampler, is nonbuoyant, and is subject to minimal stretch; however, the rope should not be reused because of the high potential for cross contamination. Stainless-steel or Teflon-coated stainless-steel wire is preferable. The weighted lines should not be reused in different wells to prevent carryover of contaminants. A possible exception is coated stainless-steel wire, which can be reused after sufficient decontamination. An alternative deployment approach, not discussed in this section, is to attach the PDB samplers to a fixed pipe in the well (Vroblesky and Peters, 2000, p. 3; also included in Part 2 of this publication). The PDB samplers should not contact non-aqueous phase liquid (NAPL) during deployment or retrieval to prevent cross contamination. An approach that can be utilized to deploy diffusion samplers through a layer of floating NAPL is described in the field test at Naval Station North Island, California (Vroblesky and Peters, 2000, p. 3-4; also included in Part 2 of this publication).

If the PDB sampler is to be compared with a conventional pumping approach to sampling, then it is suggested that both the pump and the PDB sampler be deployed at the same time, with the sampler attached near (such as directly below) the pump inlet. This approach eliminates potential concentration differences between the two methods that may result from well disturbance during equipment removal and deployment at the time of sampling. An alternative method is to deploy the PDB samplers independently of the pumps and recover the samplers immediately prior to placing the pump down the well.

PDB samplers are available either prefilled (field ready) with laboratory-grade deionized water or unfilled. The unfilled samplers are equipped with a plug and funnel to allow for field filling and sample recovery. To fill these samplers, remove the plug from the sampler bottom, insert the short funnel into the sampler, and pour laboratory-grade deionized water into the sampler. The sampler should be filled until water rises and stands at least half way into the funnel. Remove excess bubbles from the sampler. Remove the funnel and reattach the plug. A small air bubble from the plug is of no concern.

The following steps should be used for deploying PDB samplers in wells:

1. Measure the well depth and compare the measured depth with the reported depth to the bottom of the well screen from well-construction records. This is to check on whether sediment has accumulated in the bottom of the well, whether there is a nonscreened section of pipe (sediment sump) below the well screen, and on the accuracy of well-construction records. If there is an uncertainty regarding length or placement of the well screen, then an independent method, such as video imaging of the well bore, is strongly suggested.

2. Attach a stainless-steel weight to the end of the line. Sufficient weight should be added to counterbalance the buoyancy of the PDB samplers. This is particularly important when multiple PDB samplers are deployed. One approach, discussed in the following paragraphs, is to have the weight resting on the bottom of the well, with the line taut above the weight. Alternatively, the PDB sampler and weight may be suspended above the bottom, but caution should be exercised to ensure that the sampler does not shift location. Such shifting can result from stretching or slipping of the line or, if multiple samplers are attached end-to-end rather than to a weighted line, stretching of the samplers.

3. Calculate the distance from the bottom of the well, or top of the sediment in the well, up to the point where the PDB sampler is to be placed. A variety of approaches can be used to attach the PDB sampler to the weight or weighted line at the target horizon. The field-fillable type of PDB sampler is equipped with a hanger assembly and weight that can be slid over the sampler body until it rests securely near the bottom of the sampler. When this approach is used with multiple PDB samplers down the same borehole, the weight should only be attached to the lowermost sampler. An additional option is to use coated stainless-steel wire as a weighted line, making loops at appropriate points to attach the upper and lower ends of PDB samplers. Where the PDB sampler position varies between sampling events, movable clamps with rings can be used. When using rope as a weighted line, a simple approach is to tie knots or attach clasps at the appropriate depths. Nylon cable ties or stainless-steel clips inserted through the knots can be used to attach the PDB samplers. An approach using rope as a weighted line with knots tied at the appropriate sampler-attachment points is discussed below.

- (a) For 5-ft-long or shorter well screens, the center point of the PDB sampler should be the vertical midpoint of the saturated well-screen length. For example, if the well screen is at a depth of 55 to 60 ft below the top of casing, and the measured depth of the well is 59 ft, then the bottom of the well probably has filled with sediment. In this case, the midpoint of the sampler between the attachment points on the line will be midway between 55 and 59 ft, or at 57 ft. Thus, for a 1.5-ft-long sampler, the attachment points on a weighted line should be tied at distances of 1.25 ft ($2 \text{ ft} - 0.75 \text{ ft}$) and 2.75 ft ($2 \text{ ft} + 0.75 \text{ ft}$) from the top of the sediment in the well, or the bottom of the well, making adjustments for the length of the attached weight. When the PDB sampler is attached to the line and installed in the well, the center of the sampler will be at 57-ft depth. If, however, independent evidence is available showing that the highest concentration of contaminants enters the well from a specific zone within the screened interval, then the PDB sampler should be positioned at that interval.

- (b) For 5- to 10-ft-long well screens, it is advisable to utilize multiple PDB samplers vertically along the length of the well screen for at least the initial sampling (fig. 2). The purposes of the multiple PDB samplers are to determine whether contaminant stratification is present and to locate the zone of highest concentration. The midpoint of each sampler should be positioned at the midpoint of the interval to be sampled. For 1.5-ft-long samplers, at each sampling depth in the screened interval, make two attachment points on the weighted line at a distance of about 1.5 ft apart. The attachment points should be positioned along the weighted line at a distance from the bottom end of the weight such that the midpoint between the knots will be at the desired sampling depth along the well screen. Sampler intervals are variable, but a simple approach is to use the top knot/loop of one sampler interval as the bottom knot/loop for the overlying sampler interval.



Figure 2. Example of multiple PDB samplers prepared for deployment.

(c) PDB samplers should not be used in wells having screened or open intervals longer than 10 ft unless used in conjunction with borehole flow meters or other techniques to characterize vertical variability in hydraulic conductivity and contaminant distribution or used strictly for qualitative reconnaissance purposes. This is because of the increased potential for cross contamination of water-bearing zones and hydraulically driven mixing effects that may cause the contaminant stratification in the well to differ from the contaminant stratification in the adjacent aquifer material. If it is necessary to sample such wells, then multiple PDB samplers should be installed vertically across the screened or open interval to determine the zone of highest concentration and whether contaminant stratification is present.

4. The samplers should be attached to the weights or weighted line at the time of deployment. For samplers utilizing the hanger and weight assembly,

the line can be attached directly to the top of the sampler. PDB samplers utilizing an outer protective mesh can be attached to a weighted line by using the following procedure:

(a) Insert cable ties through the attachment points in the weighted line.

(b) At each end of the PDB sampler, weave the ends of the cable ties or clamp through the LPDE mesh surrounding the sampler and tighten the cable ties. Thus, each end of the PDB sampler will be attached to a knot/loop in the weighted line by means of a cable tie or clamp. The cable ties or clamps should be positioned through the polyethylene mesh in a way that prevents the PDB sampler from sliding out of the mesh.

(c) Trim the excess from the cable tie before placing the sampler down the well. Caution should be exercised to prevent sharp edges on the trimmed cable ties that may puncture the LDPE.

5. When using PDB samplers without the protective outer mesh, the holes punched at the ends of the bag, outside the sealed portion, can be used to attach the samplers to the weighted line. Stainless-steel spring clips have been found to be more reliable than cable ties in this instance, but cable ties also work well.

6. Lower the weight and weighted line down the well until the weight rests on the bottom of the well and the line above the weight is taut. The PDB samplers should now be positioned at the expected depth. A check on the depth can be done by placing a knot or mark on the line at the correct distance from the top knot/loop of the PDB sampler to the top of the well casing and checking to make sure that the mark aligns with the lip of the casing after deployment.

7. Secure the assembly in this position. A suggested method is to attach the weighted line to a hook on the inside of the well cap. Reattach the well cap. The well should be sealed in such a way as to prevent surface-water invasion. This is particularly important in flush-mounted well vaults that are prone to flooding.

8. Allow the system to remain undisturbed as the PDB samplers equilibrate.

PASSIVE DIFFUSION BAG SAMPLER AND SAMPLE RECOVERY

The amount of time that the samplers should be left in the well prior to recovery depends on the time required by the PDB sampler to equilibrate with ambient water and the time required for environmental disturbances caused by sampler deployment to return to ambient conditions. The rate that the water within the PDB sampler equilibrates with ambient water depends on multiple factors, including the type of compound being sampled and the water temperature. The concentrations of benzene, *cis*-1,2-dichloroethene (*c*DCE), tetrachlorethene (PCE), trichloroethene (TCE), toluene, naphthalene, 1,2-dibromoethane (EDB), and total xylenes within the PDB samplers equilibrated with the concentrations in an aqueous mixture of those compounds surrounding the samplers under laboratory conditions within approximately 48 hours at 21 °C (Vroblesky and Campbell, 2001). A subsequent laboratory study of mixed VOCs at 10 °C showed that PCE and TCE were equilibrated by about 52 hours, but other compounds required longer equilibration times (T.M. Sivavec and S.S. Baghel, General Electric Company, written commun., 2000). Chloroethane, *c*DCE, *trans*-1,2-dichloroethene, and 1,1-dichloroethene were not

equilibrated at 52 hours, but appeared to be equilibrated by the next sampling point at 93 hours. Vinyl chloride, 1,1,1-trichloroethane, 1,2-dichloroethane, and 1,1-dichloroethane were not equilibrated at 93 hours, but were equilibrated by the next sampling point at 166 hours. Different equilibration times may exist for other compounds. Differences in equilibration times, if any, between single-solute or mixed-VOC solutions have not yet been thoroughly examined.

Under field conditions, the samplers should be left in place long enough for the well water, contaminant distribution, and flow dynamics to restabilize following sampler deployment. The results of borehole dilution studies show that wells can recover to 90 percent of the predisturbance conditions within minutes to several hours for permeable to highly permeable geologic formations, but may require 100 to 1,000 hours (4 to 40 days) in muds, very fine-grained loamy sands, and fractured rock, and may take even longer in fractured shales, recent loams, clays, and slightly fractured solid igneous rocks (Halevy and others, 1967).

In general, where the rate of ground-water movement past a diffusion sampler is high, equilibration times through various membranes commonly range from a few hours to a few days (Mayer, 1976; Harrington and others, 2000). One field investigation showed adequate equilibration of PDB samplers to aquifer trichloroethene (TCE) and carbon tetrachloride (CT) concentrations within 2 days in a highly permeable aquifer (Vroblesky and others, 1999). In other investigations, PDB samplers recovered after 14 days were found to be adequately equilibrated to chlorinated VOCs (O'Brien & Gere Engineers, Inc., 1997a, 1997b; Hare, 2000); therefore, the equilibration period was less than or equal to 14 days for those field conditions. Because it appears that 2 weeks of equilibration probably is adequate for many applications, a minimum equilibration time of 2 weeks is suggested. When applying PDB samplers in waters colder than previously tested (10 °C) or for compounds without sufficient corroborating field data, a side-by-side comparison with conventional sampling methodology is advisable to justify the field equilibration time.

In less permeable formations, longer equilibration times may be required. It is probable that water in the well bore eventually will equilibrate with the pore-water chemistry; however, if the rate of chemical change or volatilization loss in the well bore exceeds the rate of exchange between the pore water and the well-bore water, then the PDB samplers may under-

estimate pore-water concentrations. Guidelines for equilibration times and applicability of PDB samplers in low-permeability formations have not yet been established. Therefore, in such situations, a side-by-side comparison of PDB samplers and conventional sampling methodology is advisable to ensure that the PDB samplers do not underestimate concentrations obtained by the conventional method. A detailed discussion of diffusion rates relevant to diffusion sampler equilibrium in slow-moving ground-water systems can be found in Harrington and others (2000).

Following the initial equilibration period, the samplers maintain equilibrium concentrations with the ambient water until recovery. Thus, there is no specified maximum time for sampler recovery. PDB samplers have routinely been left in ground waters having concentrations of greater than 500 ppm of TCE for 3 months at a time with no loss of bag integrity, and at one site, the PDB samplers have been left in place in VOC-contaminated ground water for 1 year with no reported loss of sampler integrity (Paul Hare, General Electric Company, oral commun., 2000). The effects of long-term (greater than 1 month) PDB-sampler deployment on sampler and sample integrity have not yet been thoroughly tested for a broad range of compounds and concentrations. Moreover, in some environments, development of a biofilm on the polyethylene may be a consequence of long-term deployment. Investigations of semipermeable membrane devices (SPMDs) have shown that the transfer of some compounds may be reduced, but not stopped, across a heavily biofouled polyethylene membrane (Ellis and others, 1995; Huckins and others, 1996; Huckins and others, in press). If a heavy organic coating is observed on a PDB sampler, it is advisable to determine the integrity of the sample by comparing contaminant concentrations from the PDB sampler to concentrations from a conventional sampling method before continuing to use PDB samplers for long-term deployment in that well.

Recovery of PDB samplers is accomplished by using the following approach:

1. Remove the PDB samplers from the well by using the attached line. The PDB samplers should not be exposed to heat or agitated.

2. Examine the surface of the PDB sampler for evidence of algae, iron or other coatings, and for tears in the membrane. Note the observations in a sampling field book. If there are tears in the membrane, the

sample should be rejected. If there is evidence that the PDB sampler exhibits a coating, then this should be noted in the validated concentration data.

3. Detach and remove the PDB sampler from the weighted line. Remove the excess liquid from the exterior of the bag to minimize the potential for cross contamination.

4. A variety of approaches may be used to transfer the water from the PDB samplers to 40-mL volatile organic analysis (VOA) vials. One type of commercially available PDB sampler provides a discharge device that can be inserted into the sampler. If discharge devices are used, the diameter of the opening should be kept to less than about 0.15 inches to reduce volatilization loss. Two options are presently available to recover water from the sample using discharge devices. One option involves removing the hanger and weight assembly from the sampler, inverting the sampler so that the fill plug is pointed upward, and removing the plug. The water can be recovered by directly pouring in a manner that minimizes agitation or by pouring through a VOC-discharge accessory inserted in place of the plug. The second approach involves piercing the sampler near the bottom with a small-diameter discharge tube and allowing water to flow through the tube into the VOA vials. In each case, flow rates can be controlled by tilting or manipulating the sampler. Alternatively, the PDB sampler can be cut open at one end using scissors or other cutting devices which have been decontaminated between use for different wells. Water can then be transferred to 40-ml VOA vials by gently pouring in a manner that minimizes water agitation. Acceptable duplication has been obtained using each method. Preserve the samples according to the analytical method. The sampling vials should be stored at approximately 4 °C in accordance with standard sampling protocol. Laboratory testing suggests that there is no substantial change in the VOC concentrations in PDB samplers over the first several minutes after recovery; however, the water should be transferred from the water-filled samplers to the sample bottles immediately upon recovery.

5. A cost-effective alternative when using multiple PDB samplers in a single well is to field screen water from each sampler using gas chromatography. These results can be used to decide which of the multiple PDB samplers should be sent to an EPA-approved laboratory for standard analysis. Typically, at least the sample containing the highest concentration should be analyzed by a laboratory.

6. If a comparison is being made between concentrations obtained using PDB samplers and concentrations obtained using a conventional sampling approach, then the well should be sampled by the conventional approach soon after (preferably on the same day) recovery of the PDB sampler. The water samples obtained using PDB samplers should be sent in the same shipment, as the samples collected by the conventional approach for the respective wells. Utilizing the same laboratory may reduce analytical variability.

7. Any unused water from the PDB sampler and water used to decontaminate cutting devices should be disposed in accordance with local, state, and Federal regulations.

DETERMINING APPLICABILITY OF PASSIVE DIFFUSION BAG SAMPLERS AND INTERPRETATION OF DATA

When attempting to determine whether the use of PDB samplers is appropriate at a particular well, a common approach is to do a side-by-side comparison with a conventional sampling method during the same sampling event. This approach is strongly suggested in wells having temporal concentration variability. In a well having relatively low temporal concentration variability, comparison of the PDB-sampler results to historical concentrations may provide enough information to determine whether the PDB samplers are appropriate for the well. In general, if both PDB and conventional sampling produce concentrations that agree within a range deemed acceptable by local, state, and Federal regulatory agencies and meet the site-specific data-quality objectives, then a PDB sampler may be approved for use in that well to monitor ambient VOC concentrations. If concentrations from the PDB sampler are higher than concentrations from the conventional method, it is probable that concentrations from the PDB sampler adequately represent ambient conditions because there usually is a greater potential for dilution from mixing during sampling using conventional methods than during sampling using PDB samplers.

If, however, the conventional method produces concentrations that are significantly higher than those obtained using the PDB sampler, then it is uncertain whether the PDB-sampler concentrations represent local ambient conditions. In this case, further testing can be done to determine whether contaminant stratification and/or intra-borehole flow is present. Multiple sampling devices can be used to determine the pres-

ence of contaminant stratification, and borehole flowmeters can be used to determine whether intra-borehole flow is present. When using flowmeters to measure vertical flow in screened boreholes, however, the data should be considered qualitative because of the potential for water movement through the sand pack. Borehole dilution tests (Halevy and others, 1967; Drost and others, 1968; Grisak and others, 1977; Palmer, 1993) can be used to determine whether water is freely exchanged between the aquifer and the well screen.

Once the source of the difference between the two methods is determined, a decision can be made regarding the well-specific utility of the PDB samplers. Tests may show that VOC concentrations from the PDB samplers adequately represent local ambient conditions within the screened interval despite the higher VOC concentration obtained from the conventional method. This may be because the pumped samples incorporated water containing higher concentrations either from other water-bearing zones induced along inadequate well seals or through fractured clay (Vroblesky and others, 2000), from other water-bearing zones not directly adjacent to the well screen as a result of well purging prior to sampling (Vroblesky and Petkewich; 2000), or from mixing of chemically stratified zones in the vicinity of the screened interval (Vroblesky and Peters, 2000).

The mixing of waters from chemically stratified zones adjacent to the screened interval during pumping probably is one of the more important sources of apparent differences between the results obtained from PDB sampling and conventional sampling because such stratification probably is common. Vertical stratification of VOCs over distances of a few feet has been observed in aquifer sediments by using multilevel sampling devices (Dean and others, 1999; Pitkin and others, 1999), and considerable variation in hydraulic conductivity and water chemistry has been observed in an aquifer in Cape Cod, Massachusetts, on the scale of centimeters (Wolf and others, 1991; Smith and others 1991; Hess and others, 1992). Multiple PDB samplers have been used to show a change in TCE concentration of 1,130 ($\mu\text{g/L}$) over a 6-ft vertical screened interval in Minnesota (Vroblesky and Petkewich, 2000). Tests using PDB samplers in screened intervals containing VOC stratification showed that the PDB-sampler data appeared to be point-specific, whereas the pumped sample integrated water over a larger interval (Vroblesky and Peters, 2000).

The decision on whether to use PDB samplers in such situations depends on the data-quality objectives for the particular site. If the goal is to determine and monitor higher concentrations or to examine contaminant stratification within the screened interval, then the PDB samplers may meet this objective. If the goal is to determine the average concentrations for the entire screened interval, then a pumped sample or an average from multiple diffusion samplers may be appropriate.

As an aid in the decision-making process, the following section examines the influences that hydraulic and chemical heterogeneity of an aquifer can have on sample quality in long-screened wells. Because VOC concentrations from PDB samplers commonly are compared to VOC concentrations from other sampling methodologies, the second section examines the differences in sample quality between these methodologies in situations of hydraulic and chemical heterogeneity.

Influences of Hydraulic and Chemical Heterogeneity on Sample Quality in Long-Screened Wells

Sampling biases and chemical variability in long-screened wells, which can be loosely defined as wells having significant physical and chemical heterogeneity within the screened interval and in the adjacent aquifer (Reilly and Leblanc, 1998), have been the subject of numerous investigations. Sources of chemical variability in such wells include non-uniform flow into wells (Robbins and Martin-Hayden, 1991; Reilly and Gibs, 1993; Chiang and others, 1995; Church and Granato, 1996; Reilly and LeBlanc, 1998), lithologic heterogeneity (Reilly and others, 1989; Robbins, 1989; Martin-Hayden and others, 1991; Gibs and others, 1993; Reilly and Gibs, 1993), and in-well mixing. In a well open across a chemically or hydraulically heterogeneous section of the aquifer, differences in the sampling methodology can produce significant differences in the sampling results.

Long-screened wells have the potential to redistribute chemical constituents in the aquifer where there are vertical hydraulic gradients within the screened interval. Water can move into the well from one horizon and exit the well at a different horizon (Church and Granato, 1996; Reilly and LeBlanc 1998). If there is vertical flow in the screened or open interval, and the zone of low hydraulic head (outflow from

the well) is within the contaminated horizon, then the PDB samplers (or any standard sampling methodology) can underestimate or not detect the contamination. The reason is that, in this case, the contaminated horizon does not contribute water to the well under static conditions. Instead, water from other horizons with higher hydraulic head will invade the contaminated horizon by way of the well screen. Under pumped conditions, the majority of the extracted water will be from the most permeable interval, which may not be the contaminated zone. Even when pumping induces inflow from the contaminated interval, much of that inflow will be a reflection of the residual invaded water from other horizons. In this situation, a substantial amount of purging would be required before water representative of the aquifer could be obtained (Jones and Lerner, 1995). Such sampling is not likely to reflect a significant contribution from the contaminated zone, and concentrations in the contaminated zone probably will be underestimated.

Similarly, if VOC-contaminated water is flowing into the well and is exiting the well at a different horizon, then VOCs will be present along the screened interval between the two horizons. In this case, VOC concentrations in the screened interval may be representative of aquifer concentrations at the inflow horizon, but may not be representative of aquifer concentrations near the outflow horizon.

In areas where vertical stratification of VOC concentrations is anticipated, using multiple PDB samplers may more fully characterize the contaminated horizon than using a single PDB sampler. This is particularly true in wells having screens 10 ft or longer; however, significant VOC stratification has been observed over intervals of less than 5 ft (Vroblesky and Peters, 2000). Because of the increased probability of vertical concentration or hydraulic gradients within the open interval of long-screened (greater than 10 ft) wells, it is advisable to determine the zones of inflow and outflow within the screened or open interval of these wells using borehole flowmeter analysis (Hess, 1982; 1984; 1986; 1990; Young and others, 1998).

Comparison of Passive Diffusion Bag Sampling Methodology to Conventional Methodologies

Traditional sampling methodologies, such as the purge-and-sample (or conventional purging method), low-flow or low-volume sampling, and using straddle packers and multilevel samplers, produce VOC

concentrations that may differ from VOC concentrations obtained from PDB samplers because the methodologies sometimes are influenced in different ways by aquifer hydraulic and chemical heterogeneity. This section examines potential sources of concentration differences between traditional methodologies and the PDB methodology.

The purge-and-sample approach to ground-water monitoring differs from the diffusion-sampler approach primarily because the area of the screened or open interval that contributes water to the purged sample typically is greater than for the PDB sampler, and the potential for mixing of stratified layers is higher. When pumping three or more casing volumes of water prior to collecting a sample, chemical concentrations in the discharging water typically change as the well is pumped (Keely and Boateng, 1987; Cohen and Rabold, 1988; Martin-Hayden and others, 1991; Robbins and Martin-Hayden, 1991; Reilly and Gibs, 1993; Barcelona and others, 1994; Martin-Hayden, 2000), due to mixing during pumping and other factors, such as the removal of stagnant water in the casing and changing patterns of inflow and outflow under ambient and pumping conditions (Church and Granato, 1996). The induction of lateral chemical heterogeneity during pumping also may produce variations in the sampled concentrations. The amount of mixing during purging can be highly variable (Barber and Davis, 1987; Church and Granato, 1996; Reilly and LeBlanc, 1998; Martin-Hayden, 2000), and may result in concentrations that are not locally representative (Reilly and Gibs, 1993). Substantial vertical hydraulic gradients, even in shallow homogeneous aquifers, have been observed to bias sampling using conventional purging because the majority of the pumped water may come from a particular horizon not related to the contaminated zone and because the intra-well flow that intruded the aquifer may not be adequately removed during purging (Hutchins and Acree, 2000). Thus, differences may be observed between concentrations obtained from a pumped sample and from a PDB sample in a chemically stratified interval if the pumped sample represents an integration of water collected from multiple horizons and the PDB sampler represents water collected from a single horizon.

Low-flow purging and sampling (Barcelona and others, 1994; Shanklin and others, 1995) disturbs the local ground water less than conventional purge-and-

sample methods. Thus, samples obtained by PDB samplers are likely to be more similar to samples obtained by using low-flow purging than to those obtained by using conventional purge-and-sample methods. Even under low-flow conditions, however, purging still can integrate water within the radius of pumping influence, potentially resulting in a deviation from VOC concentrations obtained by PDB sampling. One investigation found that in low hydraulic conductivity formations, low-flow sampling methodology caused excessive drawdown, which dewatered the screened interval, increased local ground-water velocities, and caused unwanted colloid and soil transport into the ground-water samples (Sevee and others, 2000). The authors suggest that in such cases, a more appropriate sampling methodology may be to collect a slug or passive sample from the well screen under the assumption that the water in the well screen is in equilibrium with the surrounding aquifer.

Isolating a particular contributing fracture zone with straddle packers in an uncased borehole allows depth-discrete samples to be collected from the target horizon (Hsieh and others, 1993; Kaminsky and Wylie, 1995). Strategically placed straddle packers often can minimize or eliminate the impact of vertical gradients in the sampled interval. However, even within a packed interval isolating inflowing fracture zones, deviations between VOC concentrations in water from PDB samplers and water sampled by conventional methods still may occur if the conventional method mixes chemically stratified water outside the borehole or if the packed interval straddles chemically heterogeneous zones.

The use of multilevel PDB samplers and other types of multilevel samplers (Ronen and others, 1987; Kaplan and others, 1991; Schirmer and others, 1995; Gefell and others, 1999; Jones and others, 1999) potentially can delineate some of the chemical stratification. Diffusion sampling and other sampling methodologies, however, can be influenced by vertical hydraulic gradients within the well screen or the sand pack. When vertical hydraulic gradients are present within the well, water contacting the PDB sampler may not be from a horizon adjacent to the PDB sampler. Rather, the water may represent a mixing of water from other contributing intervals within the borehole. In a screened well, even multilevel samplers with baffles to limit vertical flow in the well cannot prevent influences from

vertical flow in the gravel pack outside the well screen. Such vertical flow can result from small vertical differences in head with depth. A field test conducted by Church and Granato (1996) found that vertical head differences ranging from undetectable to 0.49 ft were sufficient to cause substantial flows (as much as 0.5 liters/minute) in the well bore.

QUALITY CONTROL AND ASSURANCE

The sources of variability and bias introduced during sample collection can affect the interpretation of the results. To reduce data variability caused during sampling, a series of quality-control samples should be utilized.

Replicate samples are important for the quality control of diffusion-sampler data. Sample replicates provide information needed to estimate the precision of concentration values determined from the combined sample-processing and analytical method and to evaluate the consistency of quantifying target VOCs. A replicate sample for water-filled diffusion samplers consists of two separate sets of VOC vials filled from the same diffusion sampler. Each set of VOC vials should be analyzed for comparison. Approximately 10 percent of the samplers should be replicated.

The length of the PDB sampler can be adjusted to accommodate the data-quality objectives for the sampling event. The length can be increased if additional volume is required for collection of replicate and matrix spike/matrix spike duplicate samples.

Trip blanks are used to determine whether external VOCs are contaminating the sample due to bottle handling and/or analytical processes not associated with field processing. Trip blanks are water-filled VOA vials prepared offsite, stored and transported with the other bottles used for collecting the environmental sample, and then submitted for analysis with the environmental sample. Consideration also should be given to the collection of a predeployment PDB trip blank to determine if the PDB samplers are exposed to extraneous VOCs prior to deployment. The predeployment trip blank should be a PDB sampler that is stored and transported with the field PDB samplers from the time of sampler construction to the time of deployment in the wells. An aliquot of the predeployment blank water should be collected from the PDB sampler in a VOA vial and submitted for analysis at the time of sampler deployment.

Water used to construct the diffusion samplers should be analyzed to determine the presence of background VOCs. Although many VOCs accidentally introduced into the diffusion-sampler water probably will reequilibrate with surrounding water once the diffusion samplers are deployed, some VOCs may become trapped within the diffusion-sampler water. For example, acetone, which is a common laboratory contaminant, does not easily move through the polyethylene diffusion samplers (Paul Hare, General Electric Company, oral commun., 1999). Thus, acetone inadvertently introduced into the diffusion-sample water during sampler construction may persist in the samplers, resulting in a false positive for acetone after sampler recovery and analysis.

SUMMARY

Water-filled passive diffusion bag (PDB) samplers described in this report are suitable for obtaining a variety of VOCs in ground water at monitoring wells. The suggested application for PDB samplers is for long-term monitoring of VOCs in ground-water wells at well-characterized sites. Where the screened interval is greater than 10 ft, the potential for contaminant stratification and/or intra-borehole flow within the screened interval is greater than in screened intervals shorter than 10 ft. It is suggested that the vertical distribution of contaminants be determined in wells having 10-ft-long well screens, and that both the vertical distribution of contaminants and the potential for intra-borehole flow be determined in wells having screens longer than 10 ft. A typical PDB sampler consists of a 1- to 2-ft-long low-density polyethylene lay-flat tube closed at both ends and containing deionized water. The sampler is positioned at the target horizon by attachment to a weighted line or fixed pipe.

The amount of time that the samplers should be left in the well prior to recovery depends on the time required by the PDB sampler to equilibrate with ambient water and the time required for environmental disturbances caused by sampler deployment to return to ambient conditions. The rate that water within the PDB sampler equilibrates with ambient water depends on multiple factors, including the type of compound being sampled and the water temperature. Concentrations of benzene, *cis*-1,2-dichloroethene, tetrachloroethene, trichloroethene, toluene, naphthalene, 1,2-dibromoethane, and total xylenes within the PDB samplers equilibrated with the concentrations in an

aqueous mixture of those compounds surrounding the samplers under laboratory conditions within approximately 48 hours at 21 °C. A subsequent laboratory study of mixed VOCs at 10 °C showed that tetrachloroethene and trichloroethene were equilibrated by about 52 hours, but other compounds required longer equilibration times. Chloroethane, *cis*-1,2-dichloroethene, *trans*-1,2-dichloroethene, and 1,1-dichloroethene were not equilibrated at 52 hours, but appeared to be equilibrated by the next sampling point at 93 hours. Vinyl chloride, 1,1,1-trichloroethane, 1,2-dichloroethane, and 1,1-dichloroethane were not equilibrated at 93 hours but were equilibrated by the next sampling point at 166 hours. Different equilibration times may exist for other compounds. Differences in equilibration times, if any, between single-solute or mixed-VOC solutions have not yet been thoroughly examined.

The samplers should be left in place long enough for the well water, contaminant distribution, and flow dynamics to restabilize following sampler deployment. Laboratory and field data suggest that 2 weeks of equilibration probably is adequate for many applications. Therefore, a minimum equilibration time of 2 weeks is suggested. In less permeable formations, longer equilibration times may be required. When deploying PDB samplers in waters colder than previously tested (10 °C) or for compounds without sufficient corroborating data, a side-by-side comparison with conventional methodology is advisable to justify the field equilibration time.

Following the initial equilibration period, the samplers maintain equilibrium concentrations with the ambient water until recovery. Thus, there is no specified maximum time for sampler recovery after initial equilibration. PDB samplers have routinely been left in ground waters having concentrations of greater than 500 ppm of TCE for 3 months at a time with no loss of bag integrity, and at one site, the PDB samplers were left in place in VOC-contaminated ground water for 1 year with no reported loss of sampler integrity. The effects of long-term (greater than 1 month) PDB-sampler deployment on sampler and sample integrity have not yet been thoroughly tested for a broad range of compounds and concentrations. In some environments, development of a biofilm on the polyethylene may be a consequence of long-term deployment. Investigations of semipermeable membrane devices

(SPMDs) have shown that the transfer of some compounds across a heavily biofouled polyethylene membrane may be reduced, but not stopped. If a heavy organic coating is observed on a PDB sampler, it is advisable to determine the integrity of the sample by comparing sampler results to a conventional sampling method concentrations before continuing to use PDB samplers for long-term deployment in that well.

PDB methodology is suitable for a broad variety of VOCs, including chlorinated aliphatic compounds and petroleum hydrocarbons. The samplers, however, are not suitable for inorganic ions and have a limited applicability for non-VOCs and for some VOCs. For example, although methyl-*tert*-butyl ether and acetone and most semivolatile compounds are transmitted through the polyethylene bag, laboratory tests have shown that the resulting concentrations were lower than in ambient water. The samplers should not be used to sample for phthalates because of the potential for the LDPE to contribute phthalates to the water sample.

When attempting to determine whether the use of PDB samplers is appropriate at a particular well, a common approach is to do a side-by-side comparison with a conventional sampling method. This approach is strongly suggested in wells having temporal concentration variability. In a well having relatively low temporal concentration variability, comparison of the PDB-sampler results to historical concentrations may provide enough information to determine whether the PDB samplers are appropriate for the well. In general, if the two approaches produce concentrations that agree within a range deemed acceptable by the local, state, and Federal regulatory agencies, then use of a PDB sampler in that well will provide VOC concentrations consistent with the historical record. If concentrations from the PDB sampler are higher than concentrations from the conventional method, then it is probable that the concentrations from the PDB sampler are an adequate representation of ambient conditions. If, however, the conventional method produces concentrations that are substantially higher than the concentrations found by using the PDB sampler, then the PDB sampler may or may not adequately represent local ambient conditions. In this case, the difference may be due to a variety of factors, including mixing or translocation due to hydraulic and chemical heterogeneity of the aquifer within the screened or open interval of the well and the relative permeability of the well screen.

REFERENCES

- Barber, C., and Davis, G.B., 1987, Representative sampling of ground water from short screened boreholes: *Ground Water*, v. 25, no. 5, p. 581-587.
- Barcelona, M., Wehrmann, H.A., and Varljen, M.D., 1994, Reproducible well-purging procedures and VOC stabilization criteria for ground-water sampling: *Ground Water*, v. 32, p. 12-22.
- Chiang, C.C., Raven, Gary, and Dawson, Clint, 1995, The relationship between monitoring well and aquifer solute concentrations: *Ground Water*, v. 32, no. 5, p. 718-126.
- Church, P.E., and Granato, G.E., 1996, Effects of well design and sampling methods on bias of water-quality samples: *Ground Water*, v. 34, no. 2, p. 262-273.
- Cohen, R.M., and Rabold, R.R., 1988, Simulation of sampling and hydraulic tests to assess a hybrid monitoring well design: *Ground Water Monitoring Review*, v. 8, no. 1, p. 55-59.
- Comyn, J., 1985, *Polymer Permeability*: New York, Elsevier Applied Science Publishers Ltd, 383 p.
- Dean, S.M., Lendvay, J.M., Barcelona, M.J., Adriaens, P., and Katopodes, N.D., 1999, Installing multilevel sampling arrays to monitor ground water and contaminant discharge to a surface-water body: *Ground Water Monitoring and Remediation*, Fall 1999, p. 90-96.
- Drost, W., Klotz, D., Koch, A., Moser, H., Neurnaier, F., and Rauert, W., 1968, Point dilutions methods of investigating ground water flow by means of radioisotopes: *Water Resources Research*, v. 4, no. 1, p. 125-146.
- Ellis, G.S., Huckins, J.N., Rostad, C.E., Schmitt, C.J., Petty, J.D., and MacCarthy, Patrick, 1995, Evaluation of lipid-containing semipermeable membrane devices for monitoring organochlorine contaminants in the upper Mississippi River: *Environmental Science and Technology*, v. 14, no. 11, p. 1875-1884.
- Flynn, G.L., and Yalkowsky, S.H., 1972, Correlation and prediction of mass transport across membrane I: Influence of alkyl chain length on flux determining properties of barrier and diffusant: *Journal of Pharmaceutical Science*, v. 61, p. 838-852.
- Gale, R.W., 1998, Three-compartment model for contaminant accumulation by semipermeable membrane devices: *Environmental Science and Technology*, v. 32, p. 2292-2300.
- Gefell, M.J., Hamilton, L.A., and Stout, D.J., 1999, A comparison between low-flow and passive-diffusion bag sampling results for dissolved volatile organics in fractured sedimentary bedrock, *in* Proceedings of the Petroleum and Organic Chemicals in Ground Water--Prevention, Detection, and Remediation Conference, November 17-19, 1999, Houston, Texas, p. 304-315.
- Gibs, Jacob, Brown, G.A., Turner, K.S., MacLeod, C.L., Jelinski, J.C., and Koehnlein, S.A., 1993, Effects of small-scale vertical variations in well-screen inflow rates and concentrations of organic compounds on the collection of representative ground water quality samples: *Ground Water*, v. 35, no. 2, p. 201-208.
- Gillham R.W., II, Robin, M.J.L., Barker, J.F., and Cherry, J.A., 1985, *Field evaluation of well flushing procedures*: Washington, D.C., American Petroleum Institute Publication 4405.
- Grisak, G.E., Merritt, W.F., and Williams, D.W., 1977, A fluoride borehole dilution apparatus for ground water velocity measurements: *Canadian Geotechnical Journal*, v. 14, p. 554-561.
- Halevy, E., Moser, H., Zellhofer, O, and Zuber, A., 1967, Borehole dilution techniques: A critical review, *Isotopes in Hydrology*: Vienna, Austria, International Atomic Energy Agency, p. 531-564.
- Hare, P.W., 2000, *Passive diffusion bag samplers for monitoring chlorinated solvents in ground water: The Second International Conference on Remediation of Chlorinated and Recalcitrant Compounds*, Battelle, May 22-25, 2000, Monterey, California.
- Harrington, G.A., Cook, P.G., and Robinson, N.I., 2000, Equilibration times of gas-filled diffusion samplers in slow-moving ground-water systems: *Ground Water Monitoring and Remediation*, Spring 2000, p. 60-65.
- Hess, A.E., 1982, A heat-pulse flowmeter for measuring low velocities in boreholes: U.S. Geological Survey Open-File Report 82-699, 44 p.
- _____ 1984, Use of a low-velocity flowmeter in the study of hydraulic conductivity of fractured rock: Proceedings of National Water Well Association Conference on Surface and Borehole Geophysics, San Antonio, Texas, p. 812-831.
- _____ 1986, Identifying hydraulically conductive fractures with a slow-velocity borehole flowmeter: *Canadian Geotechnical Journal*, v. 23, no. 1, p. 69-78.
- _____ 1990, A thermal flowmeter for the measurement of slow velocities in boreholes: U.S. Geological Survey Open-File Report 87-121.
- Hess, K.M., Wolf, S.H., and Celia, M.A., 1992, Large-scale natural gradient tracer test in sand and gravel, Cape Cod, Massachusetts, 3. Hydraulic conductivity variability and calculated macrodispersivities. *Water Resources Research*, v. 28, no. 8, p. 2011-2027.
- Hsieh, P.A., Shapiro, A.M., Barton, C.C., Haeni, F.P., Johnson, C.D., Martin, C.W., Paillet, F.L., Winter, T.C., and Wright, D.L., 1993, Methods of characterizing fluid movement and chemical transport in fractured rocks, *in* Field Trip Guidebook for the Northeastern United States: 1993 Boston GSA, Cheney, J.T., and Hepburn, J.C., eds., RI-R30. Amherst: University of Massachusetts, Department of Geology and Geography.

- Huckins, J.N., Petty, J.D., Lebo, J.A., Orazio, C.E., Prest, H.F., Tillitt, D.E., Ellis, G.S., Johnson, B.T., and Manuweera, G.K., 1996, Semipermeable membrane devices (SPMDs) for the concentration and assessment of bioavailable organic contaminants in aquatic environments, *in* Ostander, G.K., ed., *Techniques in Aquatic Toxicology*: Boca Raton, Fla., CRC-Lewis Publishers, p. 625-655.
- Huckins, J.N., Petty, J.D., Prest, H.F., Clark, R.C., Alvarez, D.A., Orazio, C.E., Lebo, J.A., Cranor, W.L., and Johnson, B.T., in press, A guide for the use of semipermeable membrane devices (SPMDs) as samplers of waterborne hydrophobic organic contaminants: Report for the American Petroleum Institute (API), Washington, DC., API publication number 4690.
- Hutchins, S.R., and Acree, S.D., 2000, Ground water sampling bias observed in shallow, conventional wells: *Ground Water Monitoring and Remediation*, Winter 2000, p. 86-93.
- Hwang, S.T., and Kammermeyer, K., 1975, *Membranes in Separations*: Malabar, Fla., Robert E. Krieger Publishing Company, Inc., 559 p.
- Jones, Ian, and Lerner, D.N., 1995, Level-determined sampling in an uncased borehole: *Journal of Hydrology*, v. 171, p. 291-317.
- Jones, Ian, Lerner, D.N., and Baines, O.P., 1999, Multiport sock samplers: A low cost technology for effective multilevel ground water sampling: *Ground Water Monitoring and Remediation*, v. 19, no. 1, p. 134-142.
- Kaminsky, J.F., and Wylie, A.H., 1995, Vertical contaminant profiling of volatile organics in a deep fractured basalt aquifer: *Ground Water Monitoring and Remediation*, v. 15, no. 2, p. 97-103.
- Kaplan, Edward; Banerjee, Sujit; Ronen, Daniel; Margaritz, Mordeckai; Machlin, Alber; Sosnow, Michael; and Koglin, Eric, 1991, Multilayer sampling in the water-table region of a sandy aquifer: *Ground Water*, v. 29, no. 2, p. 191-198.
- Kearl, P., Korte, N., and Cronk, T., 1992, Suggested modifications to ground water sampling procedures based on observations from the colloidal borescope: *Ground Water Monitoring Review*, v. 12, no. 2, p. 155-166.
- Keely, J.F., and Boateng, K., 1987, Monitoring well installation, purging, and sampling techniques - Part I: Conceptualizations: *Ground Water*, v. 25, no. 3, p. 3300-313.
- Martin-Hayden, J.M., 2000, Sample concentration response to laminar wellbore flow: Implications to ground water data variability: *Ground Water*, v. 38, no. 1, p. 12-19.
- Martin-Hayden, J.M., Robbins, G.A., and Bristol, R.D., 1991, Mass balance evaluation of monitoring well purging. Part II: Field tests at a gasoline contamination site: *Journal of Contaminant Hydrology*, v. 8, no. 3/4, p. 225-241.
- Mayer, L.M., 1976, Chemical water sampling in lakes and sediments with dialysis bags, *Limnology and Oceanography*: v. 21, p. 909-912.
- O'Brien & Gere Engineers, Inc., 1997a, Passive bag sampling results, JMT Facility, Brockport, New York: Consultant's report to General Electric Company, Albany, New York, October 10, 1997, 10 p.
- _____, 1997b, Passive bag sampling results, JMT Facility, Brockport, New York: Consultant's report to General Electric Company, Albany, New York, December 12, 1997, 10 p.
- Palmer, C.D., 1993, Borehole dilution tests in the vicinity of an extraction well: *Journal of Hydrology*, v. 146, p. 245-266.
- Pitkin, S.E., Ingleton, R.A., and Cherry, J.A., 1999, Field demonstrations using the Waterloo Ground Water Profiler: *Ground Water Monitoring and Remediation*, v. 19, no. 2, Spring 1999, p. 122-131.
- Powell, R.M., and Puls, R.W., 1993, Passive sampling of ground water monitoring wells without purging: Multi-level well chemistry and tracer disappearance: *Journal of Contaminant Hydrology*, v. 12, p. 51-77.
- Reilly, T.E., Frank, O.L., and Bennet, G.D., 1989, Bias in ground water samples caused by wellbore flow: *ASCE, Journal of Hydraulic Engineering*, v. 115, p. 270-276.
- Reilly, T.E., and Gibs, J., 1993, Effects of physical and chemical heterogeneity of water-quality samples obtained from wells: *Ground Water*, v. 31, no. 5, p. 805-813.
- Reilly, T.E., and LeBlanc, D.R., 1998, Experimental evaluation of factors affecting temporal variability of water samples obtained from long-screened wells: *Ground Water*, v. 36, no. 4, p. 566-576.
- Robin, M.J.L., and Gillham, R.W., 1987, Field evaluation on well purging procedures: *Ground Water Monitoring Review*, v. 7, no. 4, p. 85-93.
- Robbins, G.A., 1989, Influence of using purged and partially penetrating monitoring wells on contaminant detection, mapping and modeling: *Ground Water*, v. 27, no. 2, p. 155-162.
- Robbins, G.A., and Martin-Hayden, J.M., 1991, Mass balance evaluation of monitoring well purging. Part I: Theoretical models and implications for representative sampling: *Journal of Contaminant Hydrology*, v. 8, no. 3/4, p. 203-224.
- Ronen, Daniel, Magaritz, Mordeckai, and Levy, Itzhak, 1987, An *in situ* multilevel sampler for preventive monitoring and study of hydrochemical profiles in aquifers: *Ground Water Monitoring and Remediation*, Fall, p. 69-74.
- Schirmer, M., Jones, I., Teutsch, G., and Lerner, D.N., 1995, Development and testing of multiport sock samplers for ground water: *Journal of Hydrology*, v. 171, p. 239-257.

- Shanklin, D.E., Sidle, W.C., and Ferguson, M.E., 1995, Micro-purge low-flow sampling of uranium-contaminated ground water at the Fernald Environmental Management Project: Ground Water Monitoring and Remediation, v. 15, no. 3, p. 168-176.
- Sevee, J.E., White, C.A., and Maher, D.J., 2000, An analysis of low-flow ground water sampling methodology: Ground Water Monitoring and Remediation, Spring 2000, v. 20, no. 2, p. 87-93.
- Smith, R.L., Harvey, R.W., and LeBlanc, D.R., 1991, Importance of closely spaced vertical sampling in delineating chemical and microbial gradients in ground water studies: Journal of Contaminant Hydrology, v. 7, p. 285-300.
- Vrobley, D.A., 2000, Simple, inexpensive diffusion samplers for monitoring VOCs in ground water: The Second International Conference on Remediation of Chlorinated and Recalcitrant Compounds, May 22-25, 2000, Monterey, California.
- Vrobley, D.A., and Campbell, T.R., 2001, Equilibration times, stability, and compound selectivity of diffusion samplers for collection of ground-water VOC concentrations: Advances in Environmental Research, v. 5, no. 1, p. 1-12.
- Vrobley, D.A., and Hyde, W.T., 1997, Diffusion samplers as an inexpensive approach to monitoring VOCs in ground water: Ground Water Monitoring and Remediation, v. 17, no. 3, p. 177-184.
- Vrobley, D.A., Nietch, C.T., Robertson, J.F., Bradley, P.M., Coates, John, and Morris, J.T., 1999, Natural attenuation potential of chlorinated volatile organic compounds in ground water, TNX flood plain, Savannah River Site, South Carolina: U.S. Geological Survey Water-Resources Investigations Report 99-4071, 43 p.
- Vrobley, D.A., and Peters, B.C., 2000, Diffusion sampler testing at Naval Air Station North Island, San Diego County, California, November 1999 to January 2000: U.S. Geological Survey Water-Resources Investigations Report 00-4812, 27 p.
- Vrobley, D.A., and Petkewich, M.D., 2000, Field testing of passive diffusion bag samplers for volatile organic compound concentrations in ground water, Naval Industrial Reserve Ordnance Plant, Fridley, Minnesota, November 1999 and May 2000: U.S. Geological Survey Water-Resources Investigations Report 00-4246, 10 p.
- Wolf, S.H., Celia, M.A., and Hess, K.M., 1991, Evaluation of hydraulic conductivities calculated from multiport permeameter measurements: Ground Water, v. 29, no. 4, p. 516-552.
- Young, S.C., Julian, H.E., Pearson, H.S., Molz, F.J., and Boman, G.K., 1998, Application of the electromagnetic borehole flowmeter: U.S. Environmental Protection EPA/600/R-98/058, 56 p.



HYDRASleeve

Simple by Design

US Patents No. 6,481,300; No. 6,837,120; others pending

Field Manual

Introduction

The HydraSleeve groundwater sampler can be used to collect a representative sample for most physical and chemical parameters without purging the well. It collects a whole water sample from a user-defined interval (typically within the well screen), without mixing fluid from other intervals. One or more HydraSleeves are placed within the screened interval of the monitoring well, and a period of time is allocated for the well to re-equilibrate. Hours to months later, the sealed HydraSleeve can be activated for sample collection. When activated, HydraSleeve collects a sample with no drawdown and minimal agitation or displacement of the water column. Once the sampler is full, the one-way reed valve collapses, preventing mixing of extraneous, non-representative fluid during recovery.

Assembly

Assembling the HydraSleeve is simple, and can be done by one person in the field, taking only a minute or two.

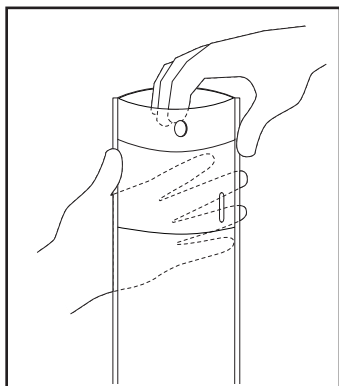

1 Remove HydraSleeve from package and grasp top to "pop" open.

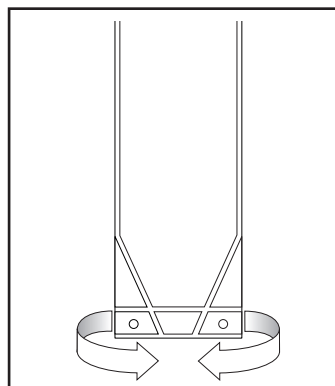

4 Fold the two holes at bottom of HydraSleeve together and attach weight

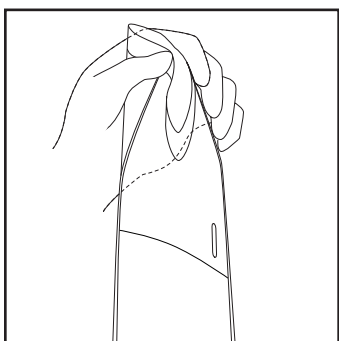

2 Squeeze side fins together at top to bend reinforcing strips outward.

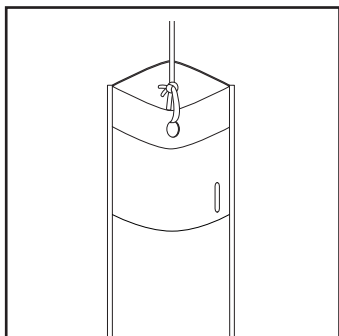

3 Attach line to hole at top of HydraSleeve.

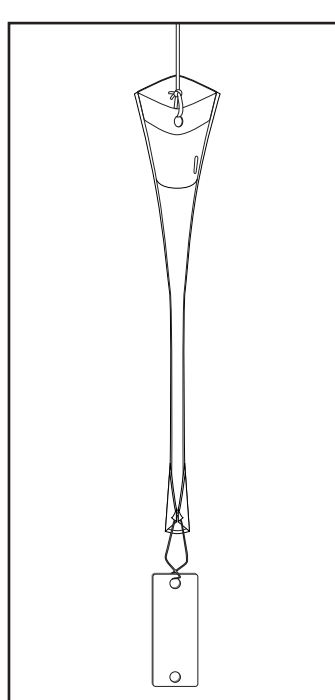

5 Sampler is ready to insert into the well.

Placing the HydraSleeve(s)

To collect a representative groundwater sample without purging, the well must be allowed time to re-equilibrate after placement of the sampler. When any device is lowered into a well, some mixing of the water column occurs. The diameter of the device and its shape greatly affect the degree of mixing. The flat cross-section of the empty HydraSleeve minimizes the disturbance to the water column as the sampler is lowered into position, reducing the time needed for the well to return to equilibrium.

There are three basic methods for holding a HydraSleeve in position as the well equilibrates.

TOP DOWN DEPLOYMENT (Figure 1)

Measure the correct amount of suspension line needed to "hang" the top of the HydraSleeve(s) at the desired sampling depth (in most cases, this will be at the bottom of the sampling zone). The upper end of the tether can be connected to the well cap to suspend the HydraSleeve at the correct depth until activated for sampling.

Note: For deep settings, it may be difficult to accurately measure long segments of suspension line in the field. Factory prepared, custom suspension line and attachment points can be provided.

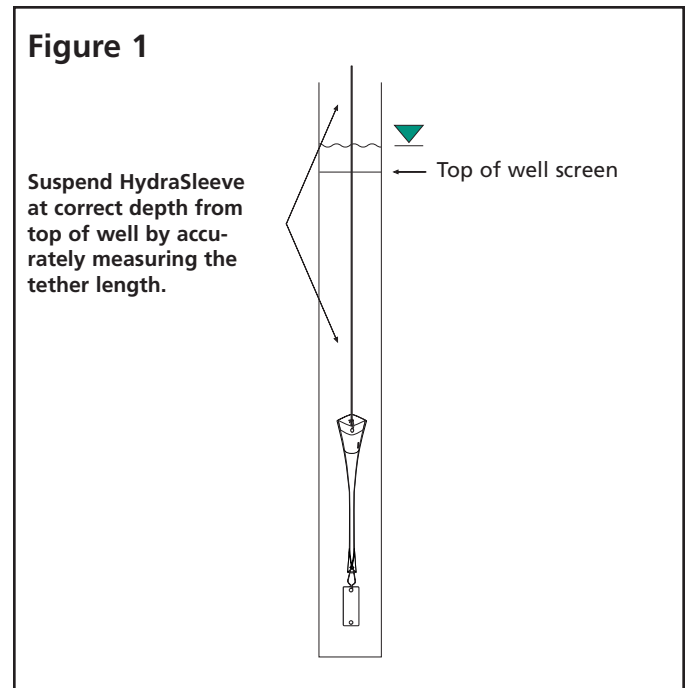

BOTTOM DEPLOYMENT (Figure 2)

Sound the well to determine the exact depth. Lower the weighted HydraSleeve into the well and let it touch the bottom. Very slowly (less than 1/2 foot per second) raise the sampler to the point where the check valve is at the depth the sample is to be collected. Attach the suspension line to the top of the well to suspend it at this depth. (It is often easier to measure a few feet from the bottom of the well up to the sample point, than it is to measure many feet from the top of the well down.)

Alternately, the sampler can be left on the bottom until the well re-equilibrates. For sampling, it can be very slowly pulled (< 1/2 fps) to sampling depth, then activated (see "Sample Collection," p. 6) to collect the sample, and retrieved to the surface.

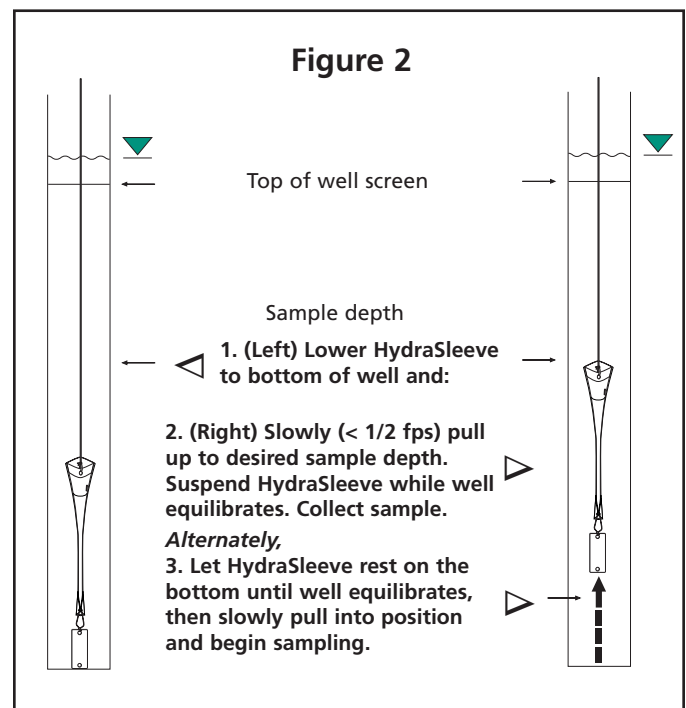

BOTTOM ANCHOR (Figure 3)

Determine the exact depth of the well.
Calculate the distance from the bottom of the well to the desired sampling depth.
Attach an appropriate length anchor line between the weight and the bottom of the sampler and lower the assembly until the weight rests on the bottom of the well, allowing the top of the sampler to float at the correct sampling depth.

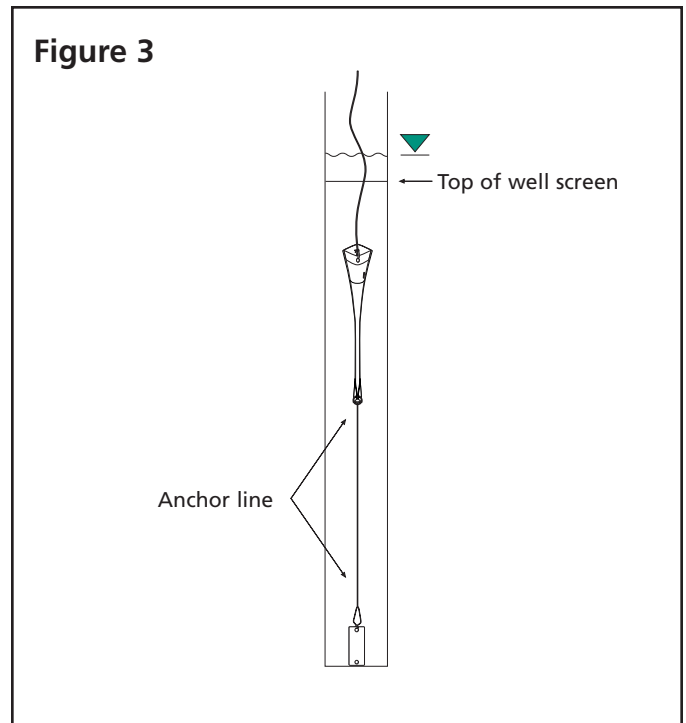

Multiple Interval Deployment

There are two basic methods for placing multiple HydraSleeves in a well to collect samples from different levels simultaneously.

ATTACHED TO A SINGLE TETHER (Figure 4)

To use 3 or more samplers simultaneously, we recommend attaching them all to a tether for support to prevent the sampling string from pulling apart. The weight is attached to a single length of suspension line and allowed to rest on the bottom of the well. The top and bottom of each HydraSleeve are attached to the tether at the desired sample intervals. Cable tie or stainless steel clips (supplied) work well for attaching the HydraSleeves to the line. Simply push one end of the clip between strands of the rope at the desired point before attaching the clip to the HydraSleeve.

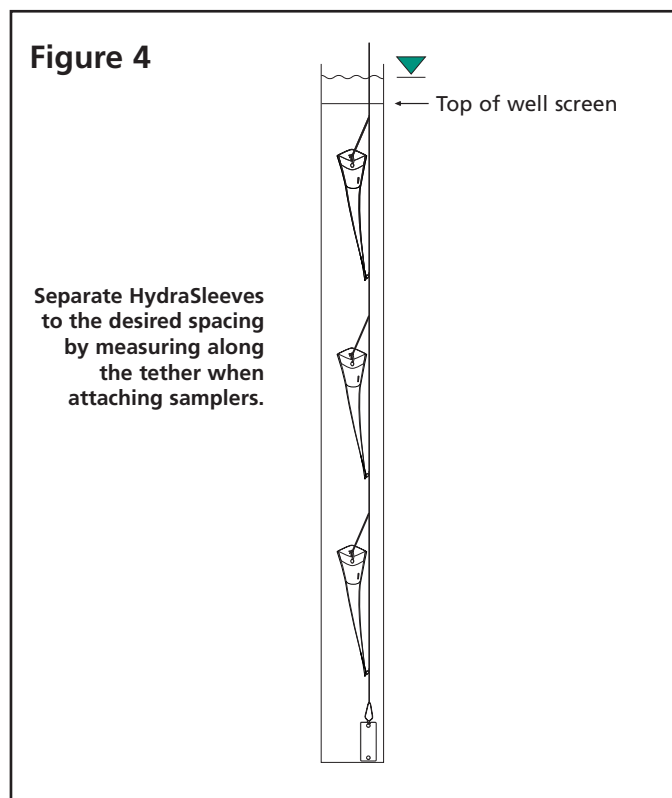

ATTACHED END TO END (Figure 5)

To place 2 or 3 stacked HydraSleeves for vertical profiling, use one of the methods described above to locate the bottom sampler. Attach the bottom of the top sampler to the top of the following HydraSleeve(s) with a carefully measured length of suspension cable. Connect the weight to the bottom sampler. Note: if many HydraSleeves are attached to a tether, more weight may be required than with a single sampler.

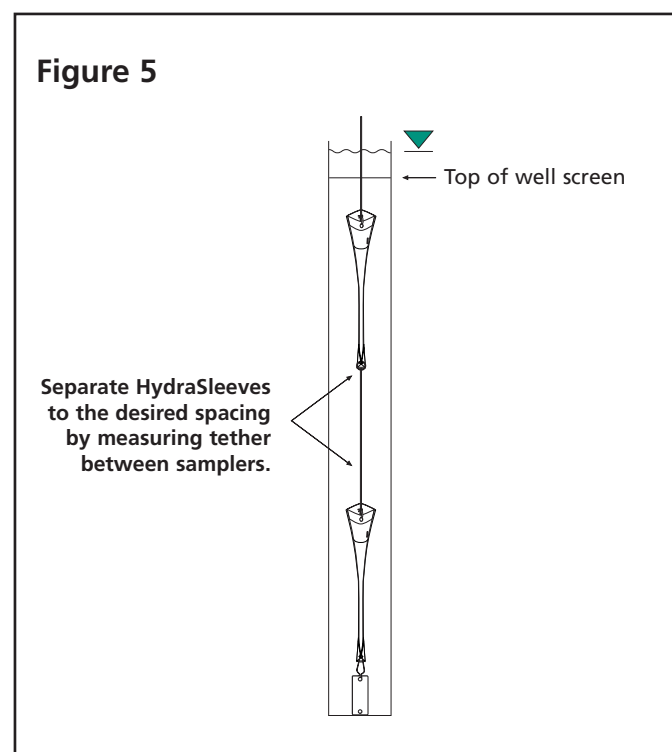

Sample Collection

The HydraSleeve must move upward at a rate of one foot per second or faster (about the speed a bailer is usually pulled upward) for water to pass through the check valve into the sample sleeve. The total upward distance the check valve must travel to fill the sample sleeve is about 1 to 2 times the length of the sampler. For example, a 24-inch HydraSleeve needs a total upward movement of 24 to no more than 48 inches to fill. The upward motion can be accomplished using one long continuous pull, several short strokes, or any combination that moves the check valve the required distance in the open position. A special technique is used for sampling low-yield wells.

CONTINUOUS PULL (Figure 6)

Pull the HydraSleeve continuously upward from its starting point at a constant 1 to 2 feet per second until full. This method usually provides the least turbid samples and is analogous to coring the water column from the bottom up.

Note: When using this method, the screen interval should be long enough so the sampler fills before exiting the top of the screen.

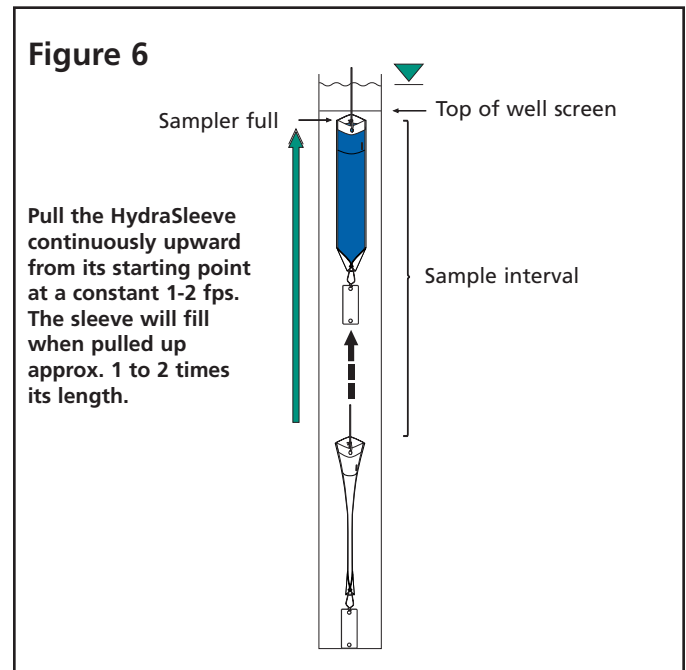

SHORT STROKES (Figure 7)

Pull the sampler upward at about 1 to 2 feet per second for the length of the sampler and let it drop back to the starting point. Repeat the cycle 3 to 5 times.

This method provides a shorter sampling interval than the continuous pull method (above), and usually reduces the turbidity levels of the sample below that of numerous rapid, short cycles (below). The sample comes from between the top of the cycle and the bottom of the sampler at its lowest point.

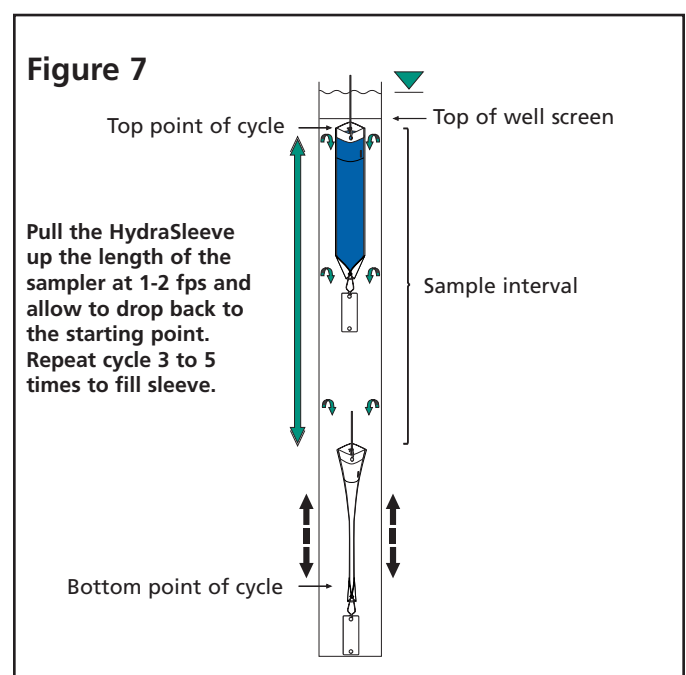

RAPID, SHORT CYCLES (Figure 8)

Cycle the HydraSleeve up and down using rapid, short strokes (6-inch cycle at a minimum of 1 cycle per second) 5 to 8 times. This method provides the shortest sampling interval. Dye studies have shown that when using this method the sample flows into the check valve from along the length of the sampler and immediately above the check valve. The sample interval is from the bottom the sampler at its lowest point in the cycle to the top of the check valve at the peak of the cycle.

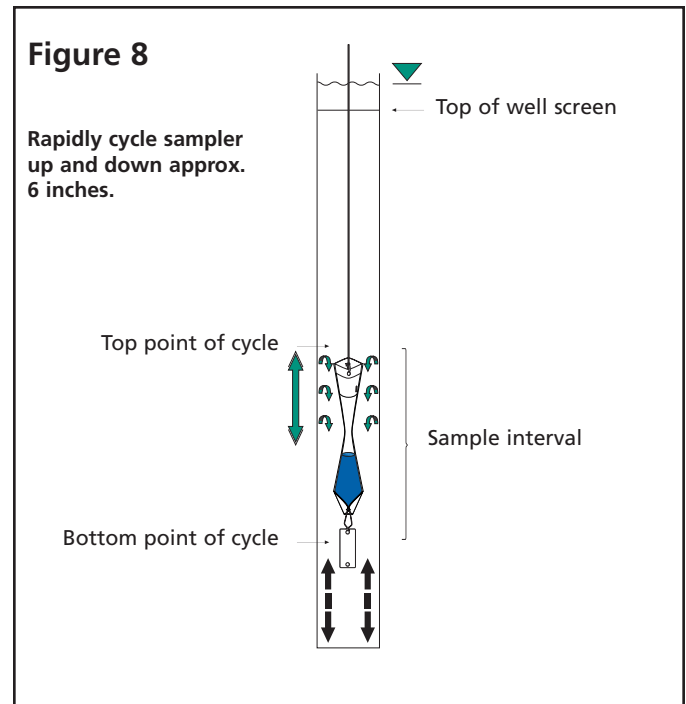

SAMPLING LOW-YIELD WELLS (Figure 9)

HydraSleeve provides the best available technology for sampling low yield wells. When pulled upward after the well re-equilibrates, the HydraSleeve will collect a water core from the top of the sampler to about its own length above that point. The sample is collected with no drawdown in the well and minimal sample agitation. An optional top weight can be attached to compress the sampler in the bottom of the well if needed for an extremely short water column. With a top weight, the check valve is pushed down to within a foot of the bottom of the well.

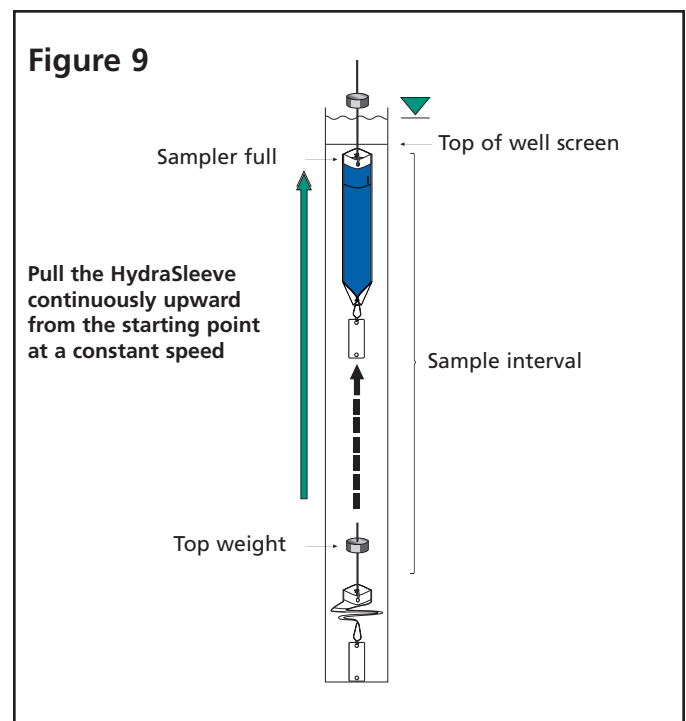

Sample Discharge

The best way to remove a sample from the HydraSleeve with the least amount of aeration and agitation is with the short plastic discharge tube (included).



First, squeeze the full sampler just below the top to expel water resting above the flexible check valve. (Photo 1, top left)



Then, push the pointed discharge tube through the outer polyethylene sleeve about 3-4 inches below the white reinforcing strips. (Photo 2, middle left)



Discharge the sample into the desired container. (Photo 3, bottom left)

Raising and lowering the bottom of the sampler or pinching the sample sleeve just below the discharge tube will control the flow of the sample. The sample sleeve can also be squeezed, forcing fluid up through the discharge tube, similar to squeezing a tube of toothpaste. With a little practice, and using a flat surface to set the sample containers on, HydraSleeve sampling becomes a one-person operation.



1680 Hickory Loop, Suite B • Las Cruces, NM 88005
Phone: 1.800.996.2225 • 1.505.523.5799 • Fax: 1.505.523.0789
www.geoinsightonline.com • KentCordry@aol.com

Attachment A: Standard Operating Procedure (SOP) #4 Supply and Irrigation Well Sampling Protocol

1.0 Sample Collection

Samples are collected from three former Fort Ord supply wells (Well 29(A), 30 (B), and 31 (C)¹) operated by the Marina Coast Water District (MCWD), and on private off post irrigation well (Mini-Storage). Samples from these wells are analyzed for VOCs by EPA Test Method 8260 SIM (selected ion monitoring) OUCTP A-Aquifer COC list on a quarterly basis². Samples are collected in three 40 milliliter (mL) VOA vials pre-preserved with hydrochloric acid (HCl). The water from these wells is collected prior to treatment or chlorination; therefore, the addition of sodium thiosulfate as a preservative is not needed.

2.0 Sample Techniques

Upon arriving at the supply well, the MCWD field technician will inform the sampler if the well is on (pumping) or off. If the pump is off, the sampler should remain outside the building until the MCWD field technician has started the pump due to noise associated with the pump's initial start-up. Once the pump is running, the sampler must open the sampling port, a small Teflon or copper tube coming from the main water flow pipe. The MCWD field technician can help locate the sampling port if the sampler is unable to identify it. Let the spigot run approximately one minute at high flow to flush the sampling port tube. A drain located in the floor near the spigot collects the discharge water. Adjust the flow rate downward until you are able to fill the 40mL VOA vials with no splashing or bubbling, letting the water flow down the side of the container. Do not overfill or rinse the container or the preservative will be lost. The 40mL VOA vials should be completely filled to the point where the water's meniscus forms a convex shape above the lip of the container. Replace the container's cap and secure snugly making sure not to over tighten, and check for headspace or bubbles. VOA vials are zero headspace and therefore if a bubble appears inside the bottle after capping, a new sample must be collected. The sample bottles are to be labeled, stored in a Ziploc bag, and placed on ice in a sample cooler immediately. The chain of custody (COC) and daily field logbook shall be filled out completely prior to moving on to the next well.

The Mini-Storage well is located in the Marina Mini-Storage yard on the north side of Reservation Road in Marina. The pump head is located just north of the parking area in the main lot. Two spigots are on the top of the pump head just outside a small garden box container. A hose may be attached to one or both spigots. The spigot where the sample will be collected should be turned on and the water allowed to flow for at least a minute. A pressure gauge is located on the pipe and will indicate when the pump has been activated. After the pump has turned on, allow the water to run for another one to one and a half minutes. Remove any hoses attached to the spigot, adjust the flow as low as reasonable, and collect the sample in the same fashion as described for the Supply Wells. When finished replace any hoses that have been removed from the spigots. The sample bottles are to be labeled, stored in Ziploc bags, and placed on ice in a sample cooler immediately. The COC and daily field logbook shall be filled out completely prior to moving on to the next well.

¹ These wells are identified as FO-29, FO-30, and FO-31, respectively.

² Unless a well is inoperable.

Attachment A: Standard Operating Procedure (SOP) #5

OU2 and Sites 2/12 GWTs and OUCTP EISB Extraction Well

Sample Handling and Custody Requirements

Table of Contents

1.0	Sample Types	A-5: 1
1.1	Extraction Well Samples	A-5: 1
1.2	GWTP Process Samples.....	A-5: 1
1.3	Quality Control (QC).....	A-5: 1
1.3.1	Trip Blanks.....	A-5: 1
1.3.2	Field Duplicate Samples	A-5: 1
2.0	Field Documentation.....	A-5: 2
2.1	Field Logbooks.....	A-5: 2
2.2	Sample Identification and Labels	A-5: 3
2.2.1	Sample Identification	A-5: 3
2.2.2	Sample Label	A-5: 5
2.3	Chain of Custody Record.....	A-5: 5
2.4	Transfer and Review of Field Documentation	A-5: 6
3.0	Groundwater Sampling	A-5: 6
3.1	Sampling Preparation.....	A-5: 6
3.2	Sampling Procedures	A-5: 7
3.3	Water-Level Measurement	A-5: 7
3.4	Sampling Equipment Calibration Procedures	A-5: 8
3.5	Decontamination Procedures	A-5: 8
4.0	Sample Handling Procedures	A-5: 9
4.1	Field Sample Custody	A-5: 9
4.2	Sample Containers and Preservation.....	A-5: 9
4.3	Sample Transfer and Shipment.....	A-5: 9
4.4	Laboratory Custody.....	A-5: 10

1.0 Sample Types

Project samples may be extraction well groundwater samples, Groundwater Treatment Plant (GWTP) process water samples, or quality control/quality assurance samples. Standard operating procedures for the collection of these water samples are described in this document.

1.1 Extraction Well Samples

Extraction well samples (standard field samples) will be generated to evaluate the effectiveness of the remedial action in containing the groundwater contamination plume, removing contaminant mass from the groundwater, and achieving remedial action objectives. Data generated will be applied to decision rules identified in the QAPP to determine operational status and sampling frequency for individual extraction wells.

1.2 GWTP Process Samples

GWTP process samples (standard field samples) will be generated to evaluate the effectiveness and efficiency of GWTP components in removing chemicals of concern (COCs) from extracted groundwater, determining the timing for replacing granular activated carbon (GAC) in the GAC vessels, and maintaining discharge limits for COCs in treated water.

1.3 Quality Control (QC)

Field QC samples will be generated to evaluate the precision, accuracy, and integrity of field sampling and laboratory analytical procedures. Quality control samples are introduced into the sample analysis stream along with environmental samples. The frequency of field QC sample generation is based on project Data Quality Objectives (DQOs), as well as the total number of samples submitted and the nature and intensity of the investigative process that is being monitored or evaluated. The following QC samples will be employed during the field program.

1.3.1 Trip Blanks

Trip blanks are prepared by the laboratory using contaminant-free water (e.g., nitrogen purged deionized water) which is poured into Volatile Organic Analysis (VOA) vials and shipped to Ahtna Environmental Inc. (Ahtna) by the laboratory. The laboratory also provides pre-cleaned and hydrochloric acid (HCl) acid-preserved sample containers for collecting water samples for Volatile Organic Compound (VOC) analysis. Trip blanks will accompany sample containers into the field and will be shipped back to the laboratory with every cooler that contains samples for VOC analyses. Trip blanks will be analyzed for all VOC analytes specified for environmental samples in the corresponding cooler.

1.3.2 Field Duplicate Samples

Duplicate samples are submitted to the contract laboratory for the purpose of assessing the effect of the sample matrix on analytical measurement precision.

The laboratory will not be informed as to the identity of duplicate samples and no special sample handling protocol will be employed during collection, shipment, or analysis of these samples. These “blind” duplicate samples will be submitted and analyzed on a frequency of one in ten of the total

environmental sampling effort for each matrix sampled. Areas of known contamination or critical sampling points may be preferentially selected for submittal as blind duplicates. Duplicate samples will be analyzed for the same parameters as the corresponding primary sample.

2.0 Field Documentation

Field activities and sample collection will be documented using the following forms and information as appropriate: sample label, chain of custody form, groundwater sampling form, well completion details, well development form, cooler receipt form, waste management label, and hazardous waste label. The purpose of standardized field documentation and sampling procedures is to maintain integrity of field documentation and field samples throughout the remediation process. Each field sample will be labeled and sealed immediately after collection. Sample identification documents will be carefully prepared to maintain control of sample disposition. Field sample custody procedures are described in Section 4.1. Standard procedures for documentation of field activities are presented below.

2.1 Field Logbooks

Field procedures relevant to sample collection and field activities will be recorded daily in permanently bound notebooks. Each individual in the field will maintain a bound field logbook with serially numbered pages. The logbook is signed and dated prior to daily initiation of field work. If logbook duties are transferred, the individuals relinquishing and receiving will both sign and date the logbook and record the transfer time. Logbook corrections are made by a single line strikeout of the incorrect entry and entering the correct information that is initialed by the person making the entry. If the correction is made at a later time or date, the correction date is also entered. Unused partial or whole logbook pages are crossed out and unused pages signed and dated at the end of each workday. All entries must be legible, in ink, and primarily factual in content. Hypothetical information can be entered but should be noted accordingly. Logbook entries may include the following information as necessary:

- Project name and number.
- Site name and location.
- Arrival and departure date/time.
- Name and affiliation of personnel onsite (including site visitors), and personnel contacted.
- Author name and date.
- Field instrument calibration methods and identification number.
- Chronology and location of activities.
- Sampling locations.
- Sample identification numbers, amount collected, sampling method and container (size/type) for each sample collected, including QC samples. Sample processing techniques such as filtration, compositing, and preservation techniques should be noted. Alternatively, this information may be contained on the COC form, groundwater sampling form, or other field form. The logbook will then contain a unique identifier linking the field log book entry to the field form.
- Date and time of sample collection, name of sampler.
- Field observations including weather conditions and applicable comments.

- Number of shipping coolers packaged and sent.
- Name and address of all receiving laboratories.
- Any modifications or deviations from quality assurance project plan.

Written reports of all significant non-routine events for field and laboratory work will be sent to the USACE Contracting Officer within 48 hours of occurrence. These reports will identify the problem, corrective action, and verbal written instructions from the USACE Project Manager (PM) to Ahtna regarding corrective action. Significant non-routine events are occurrences that impact cost of work, work schedule, work quality, and analytical data quality.

2.2 Sample Identification and Labels

2.2.1 Sample Identification

Two sample identifiers, the sample number and the station number, will be used to designate samples and sampling locations. Sample numbers will be used for coding, tracking, and reporting chemical data. Station numbers will encode sample type, site identification, and boring number or monitoring well sequence. Conventions for generating sample and station numbers are presented below.

The sample number is a coded identification designed to satisfy project and database criteria. Each sample number:

- Will contain up to 12 characters.
- Will be unique.
- Will be traceable to a specific sampling event.
- Will be traceable to a specific sampler.
- Will incorporate a specific site designation.
- Will not obviously indicate to the laboratory the sample depth, station number, or type of sample (i.e., original sample and duplicate).

All chemical data produced by the contract laboratory will be reported using the sample number. Samples will be numbered as follows (no spaces in actual sample numbers):

YR WK X SSS 000 Z

Where:

YR = Calendar year

WK = Week of the year

X = One-letter ID code assigned to each field sampler

SSS = Three-character site identification code: "OU2" or "212"

000 = Three-digit sequence number for each sample

Z = Assigned QC sample code

Assigned sample QC codes are as follows:

- A = Trip blank

- B = Not used for groundwater treatment system (GWTS) sampling
- C = Not used for GWTS sampling
- D = Field duplicate
- E = Not used for GWTS sampling
- F = Standard field sample

For example, sample number 1704M212015A represents the fifteenth sample collected by sampler "M" and is a trip blank (QC code A) collected at Sites 2/12 during Week 4 of 2017. Each sample collector will start with sequence number 001 and continue consecutively through 999. Field personnel are responsible for keeping track of their own sequence in the field logbook. Field audits will include checks of this sample numbering system to ensure that correct procedures are being followed.

Week numbers are assigned to week-long periods ending on Friday. For example, Week 4 of 2017 is the week ending January 27, 2017. Week numbers below 9 must contain a zero (i.e., 01 through 08). For aqueous samples, multiple sample containers for each discrete sample may be required to fulfill analytical requirements. In these instances, the same sample number will be used on all sample containers.

The station description is a sequence of characters designed to identify site-specific samples. Station descriptions will not be included on the laboratory copy of the chain of custody form. The station description field on the chain of custody form will be used to record the site, sample type, sequence number, and other relevant sample characteristics.

The convention for station description naming is as follows:

ST-SSS-000-XXX

Where:

ST = Sample type

SSS = Three-character site identification code (same as for sample numbering scheme)

000 = Station number unique to each station

XXX = Sample depth or aquifer

Station description names will not include spaces. Example sample type codes are as follows:

- EW = Extraction well
- MP = Multi-port well
- MW = Monitoring well
- SG = Soil gas
- SL = Sludge
- PZ = Piezometer
- TS = Treatment system
- WW = Wastewater
- VE = Vapor extraction

Sample depth may indicate the actual depth the sample was collected relative to ground surface or top of well casing (e.g. the pump intake depth), the port the sample was collected from in a multi-port well, or the aquifer the sample was collected from. Example sample depth codes for aquifers at the former Fort Ord are as follows:

- A = A-Aquifer
- 180 = Upper or Lower 180-Foot Aquifer

For example, station name EW-OU2-13-A represents an extraction well station 13 at the OU2 site with a sample depth in the A-Aquifer.

2.2.2 Sample Label

All samples will be properly labeled to prevent misidentification of samples. Preprinted sample labels will be provided. The label will be affixed to the sample container prior to transportation to the laboratory and will contain the following information:

- Project name, number, and location
- Site name
- Name of collector
- Date and time of collection
- Sample identification number
- Preservative, if any
- Requested test methods or analyses

2.3 Chain of Custody Record

A chain of custody (COC) record will be filled out for and will accompany every sample to the analytical laboratory for documentation of sample possession from the time of collection to sample receipt. A carbonless copy of the chain of custody form will be retained in the investigation files according to project number. The primary laboratory will upload copies of the cooler receipt forms and associated chain of custody forms to its LabLink website for review by the Project Chemist within 24 hours of sample receipt. The forms will contain the following information:

- Sample number or identification
- Name and signature of collector, sampler, or recorder
- Name, number, and location of project
- Project manager's name
- Date of collection
- Place of collection (station description)
- Sample type
- Analyses requested
- Dates and times of possession changes

- Signature of persons relinquishing and receiving sample
- Laboratory sample number, where applicable
- Date and time of laboratory sample receipt

2.4 Transfer and Review of Field Documentation

During site-specific field operations, copies of each field logbook page will be telefaxed or hand delivered to the Task Manager on a daily basis. In the absence of a facsimile, field staff will be in contact with the Task Manager, via mobile telephones.

At the end of each week of field operations, all field documentation will be copied, and originals sent to the Task Manager or Project Manager for review and verification. Original field documents will be kept in the project files. Verification and review of field documentation will include at a minimum, the following checks:

- Consistency of dates and times of activities; among the various field records and forms
- Consistency of sample location and identification documentation among the various field records and forms
- Accuracy and correctness of well completion details
- Correctness of sample preservation techniques

Errors or inconsistencies identified during the review process will trigger a nonconformance investigation to be conducted by the Project Chemist or Quality Control System Manager (QCSM). Appropriate corrective action will be implemented and documented if systemic errors are identified.

3.0 Groundwater Sampling

This section describes groundwater sampling procedures to be followed prior to, during, and after groundwater sample collection from monitoring wells. Procedures for collecting grab groundwater samples are described at the end of this section.

3.1 Sampling Preparation

Prior to sampling, the well vault or GWTS process sampling port will be examined for signs of tampering or deterioration and observations noted. After a well vault is opened, the Activity Hazard Analysis (AHA) may call for the air in the wellhead vicinity to be tested for organic vapors with the Photo Ionization Detector (PID) or Flame Ionization Detector (FID) and/or for explosive atmospheres with an oxygen/combustible gas indicator (see Appendix E of the Site Safety and Health Plan). Results will be recorded in the field notebook. (Note: well vault air testing is not required for routine groundwater sampling as long as previous results indicate that organic vapors or explosive atmosphere are not present). All measuring and sampling equipment will be decontaminated prior to use in any well (see Section 3.5).

Extraction wells that are not normally operated will be run to purge a minimum of three well volumes prior to sample collection. Pumped purge volumes will be estimated using the flow meter in the well vault. The volume of water purged and the withdrawal rates will be recorded. Purge rates will be sustainable and executed at a rate that minimizes drawdown to prevent water from cascading into the

well. Prior to sample collection, ports for extraction well and process sampling will be purged with the port valve completely open for a minimum of 1 minute to ensure stagnant water and any foreign matter or debris are discharged so a representative sample may be collected.

If a well is purged dry before three casing volumes have been removed, VOC samples will be collected immediately. Other samples will be taken after the well has recovered to within 80 percent of the static water level prior to purging, or after 4 hours, or when sufficient water volume is available to meet analytical requirements, whichever occurs first.

Pre-cleaned sample containers will be provided by the laboratory. The containers for each sample will be labeled in advance of the sampling event with the date, sample number, project name, sampler's name or initials, parameters for analysis (method numbers where possible), and preservation.

3.2 Sampling Procedures

After purging, samples will be collected using designated sampling ports in extraction well vaults or designated GWTS process sampling ports. Water samples will be collected carefully by discharging directly from the sample port to the appropriate sample containers.

Water samples for VOC analysis will be collected in VOA vials, which will be filled by inserting the sample port spout to the bottom of the VOA vial and keeping the spout beneath the surface of the liquid as it fills the vial until there is a convex meniscus over the neck of the bottle. The Teflon side of the septum (in the cap) will be positioned against the meniscus, and the cap screwed on tightly; the sample will be inverted, and the vial tapped lightly. The absence of an air bubble indicates a successful seal; if a bubble is evident, the sample will be discarded and the process repeated.

All sample bottles and equipment will be kept away from fuels and solvents. Gasoline (used in generators) will be transported in a different vehicle from the vehicle containing sampling equipment, sample bottles, etc. If possible, one person should be designated to handle samples and another person should operate the generators and refuel equipment, if required. Disposable gloves will be worn for each separate activity and then properly disposed. Care will be taken to avoid fuel spillage.

All samples will be packaged and transported appropriately, as described in Section 4.3.

3.3 Water-Level Measurement

The methods presented below are intended to produce water-level measurements that are consistent over multiple measurement events. Calibration and precision requirements for water-level measurements are summarized in Section 3.4.

Groundwater levels may be measured using an electrical sounder, a steel tape, or a pressure transducer. All water-level measurements will be taken from an obvious survey mark at the top edge of the well casing. Water levels will be measured using the following procedures.

Electrical Sounder

The standard equipment for making individual water-level measurements will be a battery-powered sounder. The sounder must have firmly affixed or permanent marks on the sounder line at regular intervals (minimum interval of 0.01 foot).

Calibration checks on the electrical sounder will be made periodically. The sounder markings will first be checked for the proper spacing by physically comparing the spacing with a graduated steel tape. Accuracy rechecks will be made after any incident that might alter the measuring capability of the instrument, such as cable stretching, entanglement, or sensor tip replacement.

Portions of the cable that are inserted in wells will be decontaminated after use according to the procedure described in Section 3.5. Sounders will be maintained in a clean and functional condition.

Steel Tape

A graduated steel tape (with 0.01-foot graduations) can be used for water-level measurements in conjunction with other methods and, when required, for a quality control check of other methods. The steel tape will be periodically checked for kinks, and if kinked tapes are found, the tape will be labeled as unusable and taken out of service. Portions of the tape that are inserted in wells will be cleaned after use according to the procedure described in Section 3.5. Tapes will be maintained in a clean and functional condition.

3.4 Sampling Equipment Calibration Procedures

Included is a description of the procedure or a reference to an applicable standard operating procedure, the calibration frequency, and the calibration standards used. All instruments and manufacturers' instructions and specifications are maintained in the project files. All instruments are calibrated prior to being sent to the field. Field calibration procedures will be documented in the Field Logbook.

Water-Level Measurement Instruments

Electrical sounder: Checked against steel surveyor's tape prior to initial use. Battery and sensitivity checked daily.

Graduated steel tape: Referred to new steel tape; manufacturer-supplied temperature correction is applied if appropriate for field conditions.

Pressure transducer: Factory calibrated once, in-house calibration checked with water columns prior to aquifer tests, and weekly field checks made against steel tape or electrical sounder.

3.5 Decontamination Procedures

All reusable equipment that may come in contact with potentially contaminated soil, sediment, or water will be decontaminated prior to use to reduce the potential for cross-contamination during field activities. Decontamination will consist of steam cleaning (high pressure, hot water washing); non-phosphate detergent wash; solvent rinse; distilled, deionized (DI), or clean water rinse; pesticide-grade methanol rinse; and final rinse with DI water, as appropriate.

The procedures for decontaminating sampling equipment are described below:

- Wash steel tapes, well sounders, transducers, and water quality probes in a non-phosphate detergent solution, and rinse in distilled or DI water, or wipe clean after each use, depending upon site conditions. Clean the portion of these devices inserted into wells with a mild non-phosphate detergent solution.

4.0 Sample Handling Procedures

Appropriate sample handling techniques are necessary to protect the samples and maintain sample custody protocol requirements following collection. Sample handling includes custody, container/preservative type, transfer, storage, and disposal.

4.1 Field Sample Custody

Standardized sample custody procedures will be followed through sample collection, transfer, storage, analysis, and ultimate disposal. Sample custody begins with shipment of the empty sample container sent to the office or site. All sample containers are shipped from the laboratory in sealed containers or cartons with appropriate seals and custody information. Sample quantities, types, and locations will be specified before the actual field work commences.

A sample is considered under custody if one or more of the following criteria are met:

- The sample is in the sampler's possession
- The sample is in the sampler's view
- The sample is in a designated secure area after being in the sampler's possession

4.2 Sample Containers and Preservation

Samples should be collected and containerized in order of the analyte volatilization sensitivity. A preferred collection order is listed below:

- Volatile organic compounds
- Sulfate and chloride

Methods of sample preservation are intended to retard biological action, retard hydrolysis, and reduce sorption effects. Preservation methods are generally limited to pH control, chemical addition, refrigeration, and protection from light.

All sample containers will be properly labeled (see Section 2.2) and monitored for temperature control in the field and during laboratory transport and storage. Temperature blanks will be used in all coolers containing samples requiring preservation at reduced temperature (4°C).

4.3 Sample Transfer and Shipment

Samples will always be accompanied by a chain of custody record. When transferring samples, both the individuals relinquishing and receiving the samples will sign, date, and note the transference time on the chain of custody record. Samples will be packaged properly for shipment, including isolation of samples suspected of high chemical concentrations, and dispatched to the appropriate laboratory for analysis. Custody seals will be used when samples are shipped via courier service, and must be placed on the container so that the seals have to be broken before the container can be opened. The seal must be signed and dated by the field personnel. Custody seals are not deemed necessary when the samples will be in the continuous possession of project, field, or laboratory personnel. The chain of custody record(s) will accompany each sample shipment. Samples will be packaged for shipment as follows:

- Print the following information clearly in waterproof ink on the label; the test methods requested, the

preservative(s) used (if any), the sample number, the project number, the initials of the sample collector, and the date and time the sample was collected.

- Fill out field sample log and chain of custody record as described in Sections 1.2.1 and 1.2.3, respectively.
- Place each sample bottle or set of VOA vials in a separate plastic bag and seal the bag. Squeeze air from the bag before sealing.
- If using a plastic cooler as a shipping container, tape shut the drain plug from the inside and outside, and line the cooler with a large plastic bag. If sample containers are glass, place approximately 3 inches of inert packing material, such as asbestos-free vermiculite, perlite, or Styrofoam beads in the bottom of the container or wrap the sample containers in other appropriate protective packing material (e.g., bubble wrap. Other commercial shipping containers (cardboard or fiber boxes complete with separators and preservatives) may be used but should be preapproved by the USACE.
- Place the bottles upright in the lined plastic cooler and position to avoid contact during shipment. Cardboard separators may be placed between the bottles at the discretion of the shipper.
- Transport all samples to the laboratory on ice chilled to $4^{\circ}\text{C} \pm 2^{\circ}\text{C}$.
- Place additional inert packing material in the cooler to partially cover the sample bottles (more than halfway). If samples are required to be shipped to the laboratory with ice, place ice in double bags around, among, and on top of the sample bottles, fill the cooler with inert packing material, and tape the liner shut.
- Place paperwork going to the lab inside a plastic bag. Seal the bag and tape to the inside of the cooler lid. Include the original of the COC form in the paperwork sent to the laboratory. The last block on the COC form should indicate the over-night carrier and air bill number, if applicable. Fill out the air bill before the samples are handed over to the carrier. Notify the laboratory if the shipper suspects that the sample contains any other substance that would require laboratory personnel to take additional safety precautions.
- Close the cooler and tape it securely shut.
- Place at least two signed custody seals on the cooler, one on the front and one on the side. Additional seals may be used if the sampler or shipper deems necessary. Affix "fragile" and "this end up" labels on coolers, as appropriate.
- Samples may be hand delivered to the laboratory, transported by commercial or laboratory couriers, or shipped to the laboratory using an overnight shipper.

4.4 Laboratory Custody

A designated laboratory sample custodian will accept custody of the samples and verify that the information on the sample label matches that on the chain of custody form(s). Pertinent information as to sample condition, shipment, pickup, and courier will also be checked on the chain of custody form(s). In addition, a Cooler Receipt Form (e.g., cooler receipt form) will also be completed by the custodian and copies will be sent to the project chemist within 24 hours of sample receipt. On receiving samples at the laboratory, the temperature inside the cooler and of the temperature blank will be measured immediately after opening the cooler and the results recorded on the cooler receipt form. Information on

the date and time of receipt, method of shipment, and sample condition also will be recorded on this form. The custodian will then enter the appropriate data into the laboratory sample tracking system. The laboratory custodian will use the sample number on the sample label as well as assign a unique laboratory number to each sample. The custodian will then transfer the sample(s) to the proper analyst(s) or store the sample(s) in the appropriate secure area.

Laboratory personnel are responsible for the care and custody of samples from the time they are received through sample disposal. Data sheets and laboratory records will be retained by the laboratory as part of the permanent documentation for a period of at least 3 years.

Attachment A: Standard Operating Procedure (SOP) #6 Low Flow Groundwater Quality Parameter Collection

1.0 Scope and Application

This Standard Operating Procedure (SOP) describes the procedures for calibrating and operating the field equipment necessary for collecting groundwater stabilization parameters by low flow. Groundwater stabilization parameters are obtained by using electronic equipment and are required to meet calibration standards.

2.0 Equipment List

- Decontamination equipment including soap, de-ionized and tap water
- Health and safety equipment including safety glasses and nitrile/latex exam gloves
- Field logbook, indelible ink pens and field forms
- Tools to open wells
- Horiba U-50 Series multi-meter or equivalent
- Electronic water level meter such as the Solinst Model 101 or equivalent
- Rinse water receptacle and disposal area
- Horiba pH4 multi-calibration solution or equivalent
- Horiba oxygen-reduction potential (ORP) standard powder No. 160-22 or No. 160-51 or equivalent.
- Flow-through-cell/chamber for Horiba
- Dedicated or non-dedicated submersible low flow 12 volt Geosquirt pump or equivalent
- Vehicle battery to power pump with pump controller
- Sample tubing (dedicated or non-dedicated) 3/8 inch (") or 1/2" inner diameter (ID) Polyethylene

3.0 Procedures

3.1 Multi-Meter Calibration

Water parameters are primarily recorded with the **Horiba U-50 Series** (Horiba) multi-meter (or equivalent). A wide variety of measurements can be obtained, but for groundwater stabilization parameter purposes only temperature, specific conductivity, dissolved oxygen (DO), pH, ORP, and turbidity are needed. All these parameters require calibration with the exception of temperature. According to the Horiba manual utilize approximately 200 milliliters (mL) of calibration fluid in the calibration cup. While calibrating turbidity, the lower fill line in the calibration cup is used. Remember to remove any protective caps from the sensors prior to calibration and use of the meter.

The Horiba instrument utilizes simultaneous Auto Calibration of **DO, pH, conductivity, and turbidity** with the standard pH 4 calibration solution. At a standard temperature of 25 degrees Celsius (°C); pH is

calibrated to 4.01, conductivity is calibrated to 4.49 milliSiemens per centimeter (mS/cm), DO is calibrated to 8.92 milligrams per liter (mg/L), and turbidity calibrated to 0 nephelometric turbidity units (NTU). Be sure the calibration solution is approximately the same temperature as the ambient air, if this cannot be confirmed, allow a one hour equilibration time. To perform auto calibration of the parameters listed above, follow the steps below:

1. Turn the Horiba unit on and let it warm up for approximately 20 minutes.
2. Remove the sensor guard and wash the sensor probe two to three times with deionized (DI) water.
3. Remove the transparent calibration cup.
4. Fill the transparent calibration cup to the "With TURB" labeled lower line with pH 4 standard solution.
5. Press the Horiba's "CAL" key or navigate to the Calibration menu to set the calibration mode.
6. Select "Auto Calibration".
7. Immerse the sensor probe in the transparent calibration cup.
8. Check that there are no air bubbles and the appropriate sensors are submerged.
9. Place the transparent cup with probe into the black calibration cup.
10. When all the sensor values have stabilized, press the "ENTER" key to start calibration.
11. Calibration is finished when the message "Cal complete. MEAS to measure" appears.
12. Press "MEAS" to begin reading parameters.
13. Finally, remove the calibration cup and rinse sensors and cup with DI water.

ORP is calibrated with another set of steps and materials as described below. ORP standard solution is not stable for more than an hour and therefore cannot be stored. For measuring low concentrations measurements may not be repeatable, start the measurement immediately after submersion.

1. Fill a clean beaker with one bag of ORP standard powder No. 160-22 or No. 160-51.
2. Add 250 mL of DI water and agitate the solution thoroughly (there will be some excess quinhydrone [a black powder] that floats on the surface when agitating the solution).
3. Fill the transparent calibration cup to the reference line (the upper line "Without TURB") with this ORP solution.
4. Wash the sensor probe two to three times with DI water then submerge probe into the transparent calibration cup.
5. Press the Horiba's "CAL" key or navigate to the Calibration menu to set the calibration mode.
6. Select "Manual Calibration".
7. Select "ORP".
8. Set the millivolts (mV) value of the ORP standard solution appropriate for specific temperature conditions as specified in the table below.

Temperature (°C)	ORP Powder 160-22	ORP Powder 160-51
5	+274	+112
10	+271	+107
15	+267	+101
20	+263	+95
25	+258	+89
30	+254	+83
35	+249	+76
40	+244	+69

9. Once the value has stabilized, press “ENTER” to start calibration.
10. Calibration is finished when the message “Cal complete. ENT to manual cal menu” appears.
11. Press “ENT” and then “MEAS” to begin reading parameters.
12. Finally, remove the calibration cup and rinse sensors and cup with DI water.

The auto multi-calibration and the ORP calibration of the Horiba should be performed daily. Record the auto multi-calibration and ORP calibrations were performed in the daily field logbook and other paperwork as necessary. Remember to replace any protective caps on the sensors following calibration or use of the meter and decontamination.

3.2 Site Control

- Upon arrival at groundwater monitoring well or sample station, position field vehicle in location convenient to access well as necessary for use of pump and field equipment while collecting parameters. Consider using the field vehicle to provide safety from traffic or shade from the sun.
- Establish a work area as needed. Lay out equipment in an orderly manner so as to avoid creating trip hazards. This is an important consideration in regards to cords and tubing. If necessary, use traffic cones or caution tape to define a work area and do not allow the public or subcontractors to enter your work area. Control activities in the sample collection work area so as to preserve the quality and integrity of the parameters being collected.

3.3 Water Level Measurement

Water level indicators (sounders) need to be calibrated and checked for accuracy. If more than one instrument is to be used, they should be checked by measuring a single well using both instruments to assure that measurements are consistent. A single water level meter can be checked against another tape (i.e. 100 foot reel measuring tape). Turn on unit and test the audible detector by depressing button on the site of unit before use.

Prior to leaving field office or before beginning water level measurements, decontaminate the probe and cable. Inspect well casing and locking cap for tampering, damage, maintenance needs or rust and make note of the conditions on the appropriate *Well Maintenance Form* and in the field logbook.

Use care when removing the well cap or J-plug and observe if there is a pressure difference between the closed well and atmospheric pressure. If project groundwater wells tend to build pressure attach a lanyard to well cap to eliminate the potential for injury from rapid pressure release. Never place body, face or head directly over a well while opening the well cap. Each well shall be marked with a permanent, easily identified reference point for water level measurements whose location and elevation have been surveyed. In the event a marking is not visible or well is not yet surveyed, take the water level reading from the north-side top of casing.

Don disposable silicone or nitrile exam gloves before lowering well sounder probe and measuring tape into the well. After decontaminating the sounder following water level measurement, properly dispose of exam gloves. A fresh pair of exam gloves should be used for each well or monitoring station.

Slowly lower probe into the monitoring well until contact with the water surface. An audible alarm on the water level meter will occur when the probe touches the water. Gently lift and lower the probe until an accurate measurement can be determined. Adjust well sounder sensitivity as necessary to get a good reading. Obtain the reading from the established mark on the well casing and measure to the nearest 0.01 foot. Record water level on the appropriate field forms.

After a water level measurement is collected at a groundwater monitoring well, decontaminate the measuring tape and reel. After decontamination is completed, properly secure the sounder in the sampling vehicle before moving on to the next location.

3.4 Equipment Setup

- Lie out and connect electric cords to vehicle battery from the pump. Lie out and connect pump discharge tubing from pump to flow-through-cell and from flow-through-cell to purge water storage tank. Keep tubing and equipment in shade whenever possible.
- Check the specifications for the well and place the pump at the specified depth after collecting a depth to water measurement, collecting any necessary analytical samples, and removing any hardware in the well. Make sure the pump is decontaminated accordingly with deionized water and soap between locations. Discharge tubing should be securely attached to the pump head and decontaminated or replaced between locations. Secure the pump electrical line and discharge tubing to the top of the well in a manner to avoid kinking once the desired depth has been reached. Record depth to water and depth to pump in the field log.
- Attach the end of the discharge tubing to the flow through cell that has been setup with the calibrated Horiba multi-meter. Attach the discharge of the flow through cell to a bucket for collecting purge water.
- Attach the end of the pump's electrical connector to the controller and connect the controller to the battery. The pump should start running once the controller is on and hooked up but it may

take a few minutes for water to come up to the surface. Adjust the flow accordingly if no water is being produced. Allow the flow through cell to fill before taking the first reading.

- Measure and monitor the flow rate with a graduated cylinder and record it as milliliters per minute (mL/min). Also record the cumulative volume purged as liters (L) and the water quality parameters temperature, pH, conductivity, dissolved oxygen, oxidation reduction potential, and turbidity.

Low-flow dedicated pump purging and sampling will consist of low flow 12 volt Geosquirt, or equivalent, low flow type pump to purge wells. This pump type is meant to pull water from approximately 120 feet below ground surface or shallower. If the well is too deep to pump adequately, lift the pump in the water column and record the pump depth on the field log.

The pumping rate will be maintained within the range of 0.25 to 1.0 liters per minute, limited to minimize the drawdown of the water table. Water level measurements will be collected before purging and after purging to ensure that drawdown in the well is not causing the well to go “dry”. Any well that should go “dry” during the course of sampling will be noted in the field notebook as well as on the appropriate field monitoring data sheet. After recharge time is allowed purging may be reattempted at a slower rate.

3.5 Groundwater Quality Parameter Collection

Parameters are measured from the wells by low-flow dedicated or non-dedicated pumping with a Horiba multi-meter or equivalent. Begin well documentation by filling out the top half of the water sampling log as needed.

The Horiba will be connected to a flow through cell. Parameter measurements are recorded on the sample log as follows:

- Time of measurement
- Pump intake depth (feet below top of casing)
- Flow rate (mL/min)
- Cumulative volume (L)
- Temperature (°C)
- Conductivity (mS/cm)
- DO (mg/L)
- pH (unitless)
- ORP (mV)
- Turbidity (NTU)
- Additional comments, if any

Each successive measurement will be recorded within 3-5 minutes. At least three measurements will be taken but there must be three successive readings stabilized according to the requirements below:

- pH: ± 0.1 units
- Electrical conductivity: $\pm 3\%$ mS/cm

- ORP: ± 10 mV
- Dissolved oxygen: ± 10 percent mg/L
- Temperature: ± 1.0 °C
- Turbidity: $\pm 10\%$ or less than 10.0 NTU

Well purging will be continued until the field parameters meet the criteria above, or until a maximum of three well volumes have been purged. An additional water level measurement should also be taken after monitoring is completed to assure the drop in water level is not excessive. Complete paperwork as needed.

3.6 Demobilization and Equipment Decontamination

- Stop purging the well, remove pump if non-dedicated and tubing and electrical line from the well. Re-install hardware and deploy passive diffusion bag (PDB) for next sampling event as necessary.
- Install the well cap or J-plug. Store dedicated discharge tubing in well or contain on vehicle as applicable. Decontaminate non-dedicated pump and tubing with water and soap, purging tubing by operating the pump.
- If possible, purge wells in order of lowest to highest contaminant of concern (COC) concentrations to reduce the chance of carryover from non-dedicated equipment.
- For wells located in a busy street, once all sampling equipment is packed, travel to the next scheduled location before decontaminating field equipment.
- Pumps should not be stored in an area where volatile sources (e.g., household cleaning chemicals, fuels, oils) are present; pumps shall not be stored without appropriate decontamination. Prior to use, the outside of the pump and tubing should be thoroughly rinsed with reagent grade water. Decontaminate all other equipment that contacted the well discharge water, including the water level sounder and the field meter flow-through-cell and probes.
- Collect all cords, tubing, tools and equipment and store in field vehicle in an orderly manner. Police site for trash and investigative derived waste and place in a trash bag.
- Collect any traffic control equipment while paying attention to potential traffic hazards. Never turn your back to oncoming traffic while on the street or when de-mobilizing traffic control from your work area.

3.7 Waste Management

Purged groundwater will be collected in temporary storage tanks, buckets or drums and transferred to proper storage tank for disposal at the Sites 2 and 12 groundwater treatment plant (2/12 GWTP). Non-hazardous solid wastes such as latex and nitrile gloves, plastic bags and paper towels will be collected and discarded to an approved municipal solid waste collection container.

Attachment A: Standard Operating Procedure (SOP) #7 Downhole Meter Groundwater Quality Parameter Collection

1.0 Scope and Application

This Standard Operating Procedure (SOP) describes the procedures for calibrating and operating the field equipment necessary for collecting groundwater quality parameters by downhole meter.

2.0 Equipment List

- Decontamination equipment including soap, de-ionized and tap water
- Health and safety equipment including safety glasses and nitrile/latex exam gloves
- Field logbook, indelible ink pens and field forms
- Rinse water receptacle and disposal area
- Water level meter
- Tools to open wells
- YSI 6-Series (6920) Multi-parameter Water Quality Sonde or equivalent downhole multi-parameter probe
- Calibration cup
- Probe guard
- Battery if required
- Ruler
- Barometer recommended
- Calibration solutions:
 - Conductivity: 10 milliSiemen per centimeter (mS/cm) YSI 3163 or 1 mS/cm YSI 3165 or equivalent
 - pH: pH 7 and pH 10 buffer solutions or pH 4 and pH 7 buffer solutions
 - Oxygen-reduction potential (ORP): Zobell standard recommended
 - Turbidity: two standards 0 nephelometric turbidity unit (NTU) and 100 NTU of formazin prepared by YSI, Hach, or other approved vendor.
 - Water for dissolved oxygen (DO)
- Ring stand recommended
- YSI 200 foot Sonde cable (for deeper wells)
- YSI 100 foot Sonde cable (for shallower wells)

3.0 Procedures

3.1 Downhole Meter Calibration

If the Sonde did not come with the sensors installed, install and activate the appropriate sensors per manufacturer's instructions. Remove protective caps on the sensors before calibration or use of the meter. If the meter is rented, calibration has already been performed by the vendor and field calibration is not

necessary during field events lasting less than 1 month. If the meter is rented, it is assumed that, unless warranted by erroneous field data, the meter will not require any maintenance.

To perform calibration of the Sonde, follow the general procedures below or specific manufacturer directions.

1. If installed, remove the Sonde probe guard.
2. Use the calibration cup supplied with the Sonde for all calibrations.
3. Rinse the Sonde probe and calibration cup with water and shake off excess.
4. Rinse the Sonde probe and calibration cup with a small amount of calibration solution if there is sufficient volume.
5. While calibrating the Sonde can be upright or inverted, but the sensors should be fully submerged.
6. Turn on the YSI meter and select Calibrate on the menu.

The following approximate volumes of calibration solution are to be used (check calibration solution and meter directions).

- Conductivity: 320 milliliters (mL) upright (150 mL inverted)
 - Dissolved Oxygen: 1/8 inch (") water vented to air
 - pH/ORP: 200 mL upright (150 mL inverted)
 - Optical sensors (turbidity): 225 mL upright (do not calibrate inverted)
7. Fill the calibration cup with the appropriate amount and type of calibration standard.
 - a. For conductivity, be sure the probe is dry prior to immersing and no salt deposits. Make sure the sensor is completely immersed past the vent hole. Rotate the Sonde to remove air bubbles from sensor. Allow the temperature to equilibrate for approximately one minute after submersion.
 - b. When calibrating dissolved oxygen, place 3 millimeters (mm) or 1/8" of water in the calibration cup. Engage only one or two threads of the calibration cup to vent to air. Loosen the bottom cap if the probe is inverted. Do not immerse DO or temperature sensors in the water. Wait approximately 10 minutes for the air in the calibration cup to become water saturated and for temperature equilibration.
 - c. For pH, allow approximately one minute for temperature stabilization.
 8. Screw the cup onto the probe. It is recommended to use a ring stand to prevent the probe from falling over.
 9. In the Sonde Menu select "Calibrate".
 10. Input the calibration type you are performing (i.e., conductivity, Dissolved Oxygen, pH, ORP, Turbidity).
 - a. Select Specific Conductivity for Conductivity calibration.
 - b. Calibrating for percent (%) DO will also calibrate for milligrams per liter (mg/L) DO.
 - c. For pH, enter 2-point calibration for two buffer solutions.
 - d. For turbidity, enter 2-point calibration.

11. Once a parameter is selected, some will have a number that appears in parenthesis, which is the default value to be used for calibration.
12. Check the number is correct on the calibration standard being used, and press Enter or change the calibration value accordingly.
 - a. For pH you must enter the calibration value, which is usually temperature dependent.
 - b. For DO, you must enter the current barometric pressure. If you do not have a barometer, check the local weather station and calculate according to actual elevation. Barometric pressure must be entered in mm Hg. If given in in Hg, multiply by 25.4. To calculate for elevation take the barometric pressure at sea level in your area and subtract the following; divide your location's altitude in feet above sea level by 100 and multiply by 2.5.
 - c. For turbidity, the 0 NTU standard must be calibrated first.
13. A real time value will display, with all enabled sensors reading values, not just the sensor currently being calibrated.
 - a. For turbidity activate the wiper function to remove any bubbles if necessary.
14. Observe the stabilization of the sensor value being calibrated. When the reading stabilizes for approximately 30 seconds, press Enter to accept calibration.
15. Press Enter to return to the Calibration menu, and proceed to the next calibration. Repeat steps 3-13 for each calibration standard. For pH and turbidity 2-point calibrations, the Sonde will prompt you for the second calibration solution. Dry the Sonde between readings.
16. Once completed rinse and dry the Sonde.

The Sonde is now ready to be used for readings throughout the day. Recalibrate as necessary if field conditions present erroneous data or the Sonde experiences mechanical issues. Record the calibrations were performed in the daily field logbook and other paperwork as necessary. Remember to replace any protective caps on the sensors following calibration or use of the meter and decontamination.

3.2 Site Control

- Upon arrival at groundwater monitoring well or sample station, position field vehicle in location convenient to access well as necessary for use of pump and field equipment while collecting parameters. Consider using the field vehicle to provide safety from traffic or shade from the sun.
- Establish a work area as needed. Lay out equipment in an orderly manner so as to avoid creating trip hazards. This is an important consideration in regards to cords and tubing. If necessary, use traffic cones or caution tape to define a work area and do not allow the public or subcontractors to enter your work area. Control activities in the sample collection work area so as to preserve the quality and integrity of the parameters being collected.

3.3 Water Level Measurement

Water level indicators (sounders) need to be calibrated and checked for accuracy. If more than one instrument is to be used, they should be checked by measuring a single well using both instruments to assure that measurements are consistent. A single water level meter can be checked against another tape

(i.e. 100 foot reel measuring tape). Turn on unit and test the audible detector by depressing button on the site of unit before use.

Prior to leaving field office or before beginning water level measurements, decontaminate the probe and cable. Inspect well casing and locking cap for tampering, damage, maintenance needs or rust and make note of the conditions on the appropriate *Well Maintenance Form* and in the field logbook.

Use care when removing the well cap or J-plug and observe if there is a pressure difference between the closed well and atmospheric pressure. If project groundwater wells tend to build pressure attach a lanyard to well cap to eliminate the potential for injury from rapid pressure release. Never place body, face or head directly over a well while opening the well cap. Each well shall be marked with a permanent, easily identified reference point for water level measurements whose location and elevation have been surveyed. In the event a marking is not visible or well is not yet surveyed, take the water level reading from the north-side top of casing.

Don disposable silicone or nitrile exam gloves before lowering well sounder probe and measuring tape into the well. After decontaminating the sounder following water level measurement, properly dispose of exam gloves. A fresh pair of exam gloves should be used for each well or monitoring station.

Slowly lower probe into the monitoring well until contact with the water surface. An audible alarm on the water level meter will occur when the probe touches the water. Gently lift and lower the probe until an accurate measurement can be determined. Adjust well sounder sensitivity as necessary to get a good reading. Obtain the reading from the established mark on the well casing and measure to the nearest 0.01 foot. Record water level on the appropriate field forms.

After a water level measurement is collected at a groundwater monitoring well, decontaminate the measuring tape and reel. After decontamination is completed, properly secure the sounder in the sampling vehicle before moving on to the next location.

3.4 Equipment Setup

Remove any sample or hardware from the well and allow settling time before deployment of the downhole meter, approximately five minutes. Remove hardware and take water level readings in a manner to minimize disturbance of the water column in the monitoring well, lower and remove equipment slowly.

Be sure the Sonde and cables have been decontaminated prior to deployment in the monitoring well. Connect the Sonde to the power source if needed and connect communication cable from the Sonde to the probe.

Remove the probe guard and any protective sensor caps before using the Sonde. After calibration of the meter, confirm the sensors and parameters that are needed (turbidity, temperature, DO, ORP, and conductivity) are all reading on the instrument display. Replace the probe guard and keep in place during deployment. Check the pump intake depth for the current monitoring well and attach the correct length of Sonde cable to the meter (100 foot or 200 foot cable available).

Deploy the meter into the monitoring well and secure at the top of the well once the appropriate depth has been reached as to avoid kinking. Attempt to not disturb the water column too much while deploying by lowering the meter slowly. Allow settling time before collecting parameters, approximately two minutes.

3.5 Groundwater Quality Parameter Collection

On the YSI meter menu, Select Run. Choose Discrete Sampling on the meter's menu. Discrete sampling is used for spot sampling and short term sampling. In the Discrete Sampling Menu, set the appropriate sample interval sample time length. The default sample interval is four seconds and is appropriate for most discrete sampling. Optionally, identify the location by entering a filename and site name. Then select Start Sampling. Once the sample interval time has passed (4 seconds), the data will be displayed and it can be saved by selecting Log Last Sample.

When using the downhole meter, place the meter at the specified pump depth and record one measurement on the field paperwork once stabilized. If no other readings are required, remove the Sonde and cable from the monitoring well. Replace the hardware and deploy a passive diffusion bag (PDB) as necessary for the next sampling event. Replace the well cap and secure well.

3.6 Equipment Decontamination and Waste Disposal

Decontaminate the Sonde, meter cables, and all sensor probes with deionized water and a mild detergent. A small brush may be used on the sensors if necessary. The cable connector port must always be covered to prevent moisture from entering. If the cable is not connected cover the port with the pressure cap.

For short term storage place approximately 0.5 inches of water in the calibration or storage cup and place it on the Sonde. The use of a moist sponge is also acceptable instead of water. Do not immerse the sensors. The purpose is to keep the air in the cup at 100% humidity. Any type of water may be used such as tap water, distilled water, or deionized water. Make sure the cup is on tight to prevent evaporation. Check periodically to make sure there is still water/moisture present. For Sondes with level sensors, keep the tube sealed and dry.

Containerize any decontaminate water and dispose at the Sites 2 and 12 groundwater treatment plant (2/12 GWTP). Bag up any non-hazardous solid wastes, such as disposable gloves and paper towels, for disposal in a garbage receptacle.

Analytical SOPs

1. MS010.9 Analysis of Volatile Organics by GC/MS Select Ion Monitoring (SIM) (VOCs by 8260 SIM)
2. MET108.05 Metals by Inductively Coupled Plasma Atomic Emission Spectrometry (ICP) (Metals by 6010D)
3. ORLD_WET-237-00-SOPT-IC_Metrohm Determination of Inorganic Anions by Ion Chromatography (Chloride by 9056A)
4. GN228.10 Determination of Inorganic Anions by Ion Chromatography (Chloride by 9056A)
5. ORLD-SAM-101.21-SOPT Sample Receipt and Storage
6. SAM108.11 Sample and Laboratory Waste Disposal



ANALYSIS OF VOLATILE ORGANICS BY GC/MS SELECT ION MONITORING (SIM)

Prepared by: Norm Farmer Date: 12/18/2020

Approved by: Melissa Mangual Date: 12/21/2020

Annual Review

Reviewed by: _____ Date: _____

Reviewed by: _____ Date: _____

Reviewed by: _____ Date: _____

Document Control

Issued to: QA Department - digital Date: 12/23/2020

Issued to: MS Volatile Department - digital Date: * 12/23/2020

Issued to: _____ Date: _____

Issued to: _____ Date: _____

Issued to: _____ Date: _____

Issued to: _____ Date: _____

Effective 7 days after "*" date

**CONTROLLED COPY
 DO NOT DUPLICATE**

TITLE: ANALYSIS OF VOLATILE ORGANICS BY GC/MS SELECT ION MONITORING (SIM)

REFERENCES: SW846 8260B and 8260D

REVISED SECTIONS: 1.2.1, 3.5, 6.2, 7.5.1.2, 7.5.2.2, 11.2 and 12.0

1.0 SCOPE AND APPLICATION, SUMMARY

1.1 Scope and Application

- 1.1.1 This method is used to determine the concentrations of various volatile organic compounds in water utilizing a gas chromatograph equipped with a mass spectrometer detector. This SOP was written primarily for the analysis of 1,4-dioxane but the analytes listed in Table 1 have also been validated by this method.
- 1.1.2 Unlike conventional full scan 8260, this method utilizes the instrument's selected ion monitoring (SIM) capabilities. By monitoring for a few specific ions the sensitivity can be increased 10 to 20 fold.
- 1.1.3 Utilizing a heated purge greatly improves the purge efficiency of 1,4-dioxane from water.
- 1.1.4 The Lower Limit of Quantitation (LLOQ) or Reporting limits (RL) are based on the sample amount and the lowest calibration standard. LLOQs may vary depending on matrix complications and sample volumes. The LLOQ for 1,4-dioxane by this method are 1.0 ug/l for aqueous samples and 5.0 ug/kg for solid samples. The LLOQs for the additional analytes listed in Table 1 are 0.1 to 0.5ug/l for aqueous samples and 5 to 25ug/kg for methanol soils. Solid matrices are reported on a dry weight basis.
- 1.1.5 The Method Detection Limit (MDL) for each analyte is evaluated on an annual basis for each matrix and instrument. MDLs are pooled for each matrix, and the final pooled MDLs are verified. The verified MDLs are stored in the LIMS and should be at least 2 to 3 times lower than the LLOQ. Exceptions may be made on a case by case basis; however, at no point shall the MDL be higher than the reported LLOQ.
- 1.1.6 The LLOQ for each analyte is evaluated on an annual basis for each matrix and instrument. The LLOQ verifications are prepared by spiking a clean matrix at 0.5 to 2 times the current LLOQ level. This LLOQ verification is carried through the same preparation and analytical procedures as the samples. Recovery of the analytes should be within the established limits. The DOD QSM requirements for Limit of Detection (LOD) and Limit of Quantitation (LOQ) verifications are different. See SOP QA020 for complete requirements for MDL, LOD, LOQ, and LLOQ.

**CONTROLLED COPY
DO NOT DUPLICATE**

- 1.1.7 Compounds detected at concentrations between the LLOQ and MDL are quantitated and qualified as estimated values and reported with either a "J" or "I" qualifier. Some program or project specifications may require that no values below the LLOQ be reported.
- 1.1.8 For DOD projects, refer to QSM 5.0, Table 4; QSM 5.1, Table B-4; or QSM 5.3, Table B-4 for additional method requirements and data qualifying guidance.

1.2 Summary

- 1.2.1 This method is adapted from SW846 method 8260B and 8260D.
- 1.2.2 Samples are received, stored, and analyzed within the appropriate holding times.
- 1.2.3 Sample preparation is performed in accordance with SGS Orlando SOP OP020 and OP021.
- 1.2.4 The samples are analyzed on a gas chromatograph equipped with mass spectrometer detector.
- 1.2.5 The peaks detected are identified by comparison to characteristic ions and retention times specific to the known target list of compounds.
- 1.2.6 Library searches cannot be performed on data acquired in SIM mode because data was only acquired for selected ions.
- 1.2.7 Manual integrations are performed in accordance with SOP QA029.

2.0 PRESERVATION AND HOLDING TIME

2.1 Preservation

Aqueous Samples:

- 2.1.1 Samples should be preserved to a pH < 2. The pH must be checked and recorded immediately after the sample analysis. If the sample is not preserved to a pH < 2, it must be noted on the report.
- 2.1.2 The samples must be stored in capped vials, with minimum headspace, at ≤ 6 °C in an area free of solvent fumes. The size of any bubble caused by degassing upon cooling should not exceed 5-6mm.

Solid Samples:

- 2.1.3 Special 40ml vials for purge-and-trap of solid samples, as well as the collection and preservation options are described in OP020.

2.1.4 Low level soil samples are preserved by storing them in sealed VOA vials at temperatures between $-10\text{ }^{\circ}\text{C}$ to $-20\text{ }^{\circ}\text{C}$. High level soil samples are preserved by storing them in methanol at a ratio of 1 gram of soil to 1ml of methanol.

2.2 Holding Time

2.2.1 Aqueous samples are to be analyzed within 14 days of collection, unless otherwise specified by the contract. Samples that are not preserved must be analyzed within 7 days of collection; however, the preservation deficiency must be noted in the report.

2.2.2 Solid and waste samples must be analyzed within 14 days of collection.

3.0 INTERFERENCES

3.1 Data from all blanks, samples, and spikes must be evaluated for interferences.

3.2 Impurities in the purge gas, organic compounds out-gassing from the plumbing ahead of the trap, and solvent vapors in the laboratory account for the majority of contamination problems. The analytical system must be demonstrated to be free from contamination under the conditions of the analysis by running laboratory blanks. The use of non-TFE tubing, non-TFE thread sealants, or flow controllers with rubber components in the purging device should be avoided.

3.3 Samples can be contaminated by diffusion of volatile organics (particularly methylene chloride and fluorocarbons) through the septum seal into the sample during shipment and storage. A trip blank can serve as a check on such contamination.

3.4 Contamination by carry-over can occur whenever high level and low-level samples are sequentially analyzed. Whenever an unusually concentrated sample is encountered, it should be followed by an analysis of reagent water to check for carry-over.

3.5 SIM may provide a lesser degree of confidence in compound identification unless multiple ions are monitored for each compound. In general, SGS Orlando monitors 3 ions per compound.

3.6 Historically 1,4-dioxane was used as a stabilizer for various chlorinated solvents such as trichloroethene and tetrachloroethene. Samples that contain 1,4-dioxane often contain trichloroethene and/or tetrachloroethene at orders of magnitude higher concentrations. Because of this, it is best to analyze samples for 1,4-dioxane on a system dedicated to only the analysis of 1,4-dioxane.

4.0 DEFINITIONS

4.1 Batch: A group of samples which are similar with respect to matrix and the testing procedures being employed and which are processed as a unit. A sample batch is limited

to a maximum of 20 samples or samples loaded on an instrument within the same 12-hour shift, whichever comes first.

- 4.2 Blank Spike (BS): An analyte-free matrix spiked with a known amount of analyte(s), processed simultaneously with the samples through all the steps of the analytical procedure. Blank Spike recoveries are used to document laboratory performance for a given method. This may also be called a Laboratory Control Sample (LCS).
- 4.3 Continuing Calibration Verification (CCV): A check standard used to verify instrument calibration throughout an analytical run. For all MS methods, a CCV must be analyzed at the beginning of each analytical run. For DoD QSM 5.x projects, an additional CCV must be analyzed at the end of the run.
- 4.4 Holding Time: The maximum times that samples may be held prior to preparation and/or analysis and still be considered valid.
- 4.5 Internal Standards: An organic compound which is similar to the target analyte(s) in chemical composition and behavior, but which is not normally found in environmental samples. Internal standards for mass spec methods are often deuterated forms of target analytes. Internal standards are used to compensate for retention time and response shifts during an analytical run.
- 4.6 Initial Calibration (ICAL): A series of standards used to establish the working range of a particular instrument and detector. The low point must be at a level equal to or below the LLOQ.
- 4.7 Initial Calibration Verification (ICV): A standard from a source different than that used for the initial calibration. A different vendor must be used whenever possible. The ICV is used to verify the validity of an Initial Calibration. This may also be called a QC check standard.
- 4.8 Matrix Spike (MS): A sample aliquot spiked with a known amount of analyte(s), processed simultaneously with the samples through all the steps of the analytical procedure. The matrix spike recoveries are used to document the bias of a method in a given sample matrix.
- 4.9 Matrix Spike Duplicate (MSD): A replicate sample aliquot spiked with a known amount of analyte(s), processed simultaneously with the samples through all the steps of the analytical procedure. The matrix spike duplicate recoveries are used to document the precision and bias of a method in a given sample matrix.
- 4.10 Method Blank (MB): An analyte-free matrix to which all reagents are added in the same volumes or proportions as used in sample processing. The method blank is processed simultaneously with the samples through all the steps of the analytical procedure. The method blank is used to document contamination resulting from the analytical process.
- 4.11 Sample Duplicate (DUP): A replicate sample which is used to document the precision of a method in a given sample matrix.

- 4.12 Preservation: Refrigeration and/or reagents added at the time of sample collection (or later) to maintain the chemical integrity of the sample.
- 4.13 Surrogate: An organic compound which is similar to the target analyte(s) in chemical composition and behavior, but which is not normally found in environmental samples. Surrogates are used to measure the purge efficiency.
- 4.14 Trip Blank: A sample of analyte-free matrix taken from the laboratory to the sampling site and returned to the laboratory unopened. A trip blank is used to document contamination attributable to shipping and field handling procedures. This type of blank is useful in documenting contamination of volatile organic samples.

5.0 REAGENTS

- 5.1 Reagent water – distilled or deionized water free of interferences
 - 5.2 Methanol – purge-and-trap grade or equivalent
 - 5.3 Hydrochloric acid (HCl) – ACS reagent grade or equivalent
 - 5.4 Inert Gas – UHP Helium or UHP Nitrogen
 - 5.5 1,4-Dioxane stock standards – traceable to Certificate of Analysis
 - 5.6 4-Bromofluorobenzene (BFB) – instrument tuning mix
 - 5.7 Surrogate standards – (varies based on analytes being reported)
- Dibromofluoromethane
1,2-Dichloroethane-d₄
Toluene-d₈
- 5.8 Internal standards – (varies based on analytes being reported)

Fluorobenzene
Chlorobenzene-d₅
1,4-Dioxane-d₈

6.0 APPARATUS

- 6.1 Gas Chromatograph – Agilent Technologies 6890 or 7890
 - 6.1.1 Gas Chromatograph

The analytical system that is complete with a temperature programmable gas chromatograph and all required accessories, analytical columns, and gases.

6.1.2 The injection port is designed for split-splitless injection with capillary columns. The injection port must have an appropriate interface for sample introduction.

6.2 Mass Spectrometer– Agilent Technologies 5973 or 5975

The mass spectrometer must be capable of scanning from 35-300 amu every second or less, utilizing 70-volt (nominal) electron energy in the electron impact ionization mode. It must also be capable of producing a mass spectrum that meets all the criteria in section 7.5.1.1 when injecting 50 ng of bromofluorobenzene (BFB).

For this method it also must be capable of operating in Select Ion Mode (SIM). The selected ions are nominal ions but may have small mass defect, usually less than 0.2 amu, in their spectra. The acquisition table must be set to include these mass defects. The dwell time may be automatically calculated by the laboratory's GC/MS software. The total scan time must be less than 1,000 msec and produce at least 5 to 10 scans per chromatographic peak.

The mass spectrometer must be capable of analyzing multiple groups for up to 30 specific ions. Use the primary ion for quantitation and the secondary ions for confirmation. The start and end of each group must be time programmable and can be determined from the full scan analysis. Each group of specific ions is referred to as a descriptor.

6.3 Purge and Trap – OI Analytical 4660 with OI Analytical 4552 or 4551A or EST Evolution with EST Centurion

6.3.1 The following autosampler models are used for purging, trapping and desorbing the sample onto GC column.

- O.I. Model 4660 sample concentrator with 4552 Water/Soil multisampler
- O.I. Model 4660 sample concentrator with 4551A Water multisampler
- EST Evolution sample concentrator with Centurion Water/Soil multisampler

6.3.2 The sample purge vessel must be designed to accept 5 ml samples with a water column at least 3 cm deep.

6.3.3 The multisampler or concentrator is equipped with a heater capable of maintaining the purge chamber at 60 °C to improve purging efficiency.

6.3.4 The desorber must be capable of rapidly heating the trap to the manufacturer recommended desorb temperature.

6.4 Data System – Agilent Technologies MS Chemstation rev. DA 02.0x, DA 03.0x or EA 02.0x.

6.4.1 A computer system interfaced to the mass spectrometer that allows for the continuous acquisition and storage of all mass spectral data obtained throughout the duration of the chromatographic program.

- 6.4.2 The computer utilizes software that allows searching any GC/MS data file for ions of a specific mass and that can plot such ion abundances versus time or scan number. This type of plot is defined as an Extracted Ion Current Profile (EICP).
- 6.4.3 The software must allow for integrating the abundances in any EICP between specific time or scan number limits. See Table 2.
- 6.4.4 Data is archived to a backup server for long term storage.
- 6.5 Trap – OI #10 or equivalent: Tenax, Silica Gel, and Carbon Molecular Sieve.
Trap – Vocab 3000 (K) or equivalent: Carboxen 1000, Carboxen 1001

The trap should be conditioned according to the manufacturer's recommendations.
- 6.6 Columns – RTX-624 or equivalent: 60m X 0.25mm 1.4um.
– RTX-VMS or equivalent: 40m X 0.18mm 1.0um
- 6.7 Gas-tight syringes and class "A" volumetric glassware for dilutions of standards and samples.

7.0 PROCEDURE

7.1 Standards Preparation

Standards are prepared from commercially available certified reference standards. All standards must be logged in the Volatile Standards Logbook. All standards shall be traceable to their original source. The standards must be stored at temperatures between -10°C and -20°C , or as recommended by the manufacturer. Calibration levels, spike and surrogate concentrations, preparation information, and vendor part numbers can be found in the MSVOA STD Summary in the Active SOP directory.

7.1.1 Stock Standard Solutions

Stock standards are available from several commercial vendors. All vendors must supply a "Certificate of Analysis" with the standard. The certificate will be retained by the lab. Hold time for unopened stock standards is until the vendor's expiration date. Once opened, the hold time is reduced to six months (one month for gases) or the vendor's expiration date (whichever is shorter).

7.1.2 Intermediate Standard Solutions

Intermediate standards are prepared by quantitative dilution of the stock standard with methanol. The hold time for intermediate standards is one month (one week for gases) or the vendor's expiration date (whichever is shorter). Intermediate standards may need to be remade if comparison to other standards indicates analyte degradation or concentration changes.

7.1.3 Calibration Standards

Calibration standards for the volatile organics are prepared at a minimum of five concentration levels through quantitative dilutions of the intermediate standard. The low standard concentration is at or below the LLOQ, and the remaining standards define the working range of the detector.

Calibration standard concentrations are verified by the analysis of an initial calibration verification (ICV) standard.

7.2 Instrument Conditions

Gas Chromatograph/ Mass Spectrometer

Carrier gas flow	1.0-1.3 ml/min
Transfer line temperature	220 - 280 °C
Analyzer temperature	150 °C

Oven program – 45 °C for 2.5 minutes (RTX-VMS 40m)
10 °C/min to 80 °C for 0 minutes
15 °C/min to 185 °C for 0 minutes
30 °C/min to 240 °C for 2.5 minutes

Oven program – 35 °C for 2.5 minutes (RTX-VMS 40m)
4 °C/min to 60 °C for 0 minutes
25 °C/min to 220 °C for 0 minutes
30 °C/min to 240 °C for 1.2 minutes

Oven program – 45 °C for 2.0 minutes (RTX-624)
10 °C/min to 80 °C for 0 minutes
14 °C/min to 210 °C for 0 minutes
16 °C/min to 240 °C for 4.2 minutes

GC conditions are optimized for each instrument. Actual conditions may vary slightly from those listed above.

MS Descriptors – Monitor 3 characteristic ions for each target analyte, and 2 characteristic ions for each surrogate and internal standard. Each descriptor may have up to 30 ions; however, the more ions in a descriptor, the less the sensitivity. Therefore, it is beneficial to use multiple descriptors for longer analytes lists. Refer to the specific instrument methods for actual descriptors.

7.3 Purge and Trap Device conditions

OI Autosampler

Purge Gas:	Helium or Nitrogen at 30-45 ml/min
Sample Temp:	Aqueous (Ambient) Soils (40°C)

CONTROLLED COPY
DO NOT DUPLICATE

Trap Temp:	<25°C
Purge Time:	6 or 11 min
Desorb:	2 min. at 190°C
Bake:	5 min. at 210°C

EST Autosampler

Purge Gas:	Helium at 35-45 ml/min
Sample Temp:	Aqueous (Ambient to 35°C) Soils (40°C)
Trap Temp:	<35°C
Purge Time:	6 or 11 min
Desorb:	1-2 min. at 250°C
Bake:	6 min. at 235°C

Purge and Trap conditions are optimized for each instrument. Actual conditions may vary slightly from those listed above.

NOTE: Due to the poor purge efficiency of 1,4-dioxane, purge times of less than 11 minutes should not be used when analyzing for 1,4-dioxane.

7.4 Sample Preparation

7.4.1 Water Samples

A 5ml aliquot of sample is loaded onto the purge-and-trap device and purged for 6 or 11 minutes at 60°C. Detailed procedures are described in SOP OP021.

7.4.2 Solid Samples

A 5-gram aliquot of sample is loaded onto the purge-and-trap device. 5mls of reagent water is added along with internal standards and surrogates. The sample is then purged for 6 or 11 minutes while heated to 40°C and mechanically agitated. Detailed procedures are described in SOP OP020.

Alternatively, a methanol aliquot from the sample is loaded onto the purge-and-trap device. 5mls of reagent water is added along with internal standards and surrogates. The sample is then purged for 6 or 11 minutes. Detailed procedures are described in SOP OP020 and OP021.

7.5 Gas Chromatographic Analysis

Instrument calibration consists of two major sections:

Initial Calibration Procedures
Continuing Calibration Verification

7.5.1 Initial Calibration Procedures

Before samples can be run, the GC/MS system must be tuned, the injection port inertness must be verified, and the instrument must be calibrated.

**CONTROLLED COPY
DO NOT DUPLICATE**

7.5.1.1 Tune Verification (BFB)

The instrument must be hardware tuned per manufacturer's instructions. Verify the instrument tune by injecting 50ng of BFB solution onto the instrument. The BFB standard may also be purged. The resulting BFB spectra must meet the criteria in the following table.

BFB KEY IONS AND ION ABUNDANCE CRITERIA

Mass	Ion Abundance Criteria
50	15-40% of mass 95
75	30-60% of mass 95
95	Base peak, 100% relative abundance
96	5-9% of mass 95
173	<2% of mass 174
174	>50% of mass 95
175	5-9 % of mass 174
176	>95% and <101% of mass 174
177	5-9% of mass 176

Evaluate the tune spectrum using three mass scans from the chromatographic peak and a subtraction of instrument background. This procedure is performed automatically by the MS Chemstation software by running "autofind" on the BFB peak.

Select the scans at the peak apex and one to each side of the apex. Calculate an average of the mass abundances from the three scans.

Background subtraction is required. Select a single scan in the chromatogram that is absent of any interfering compound peak and no more than 20 scans prior to the elution of BFB. The background subtraction must be designed only to eliminate column bleed or instrument background ions. Do not subtract part of the tuning compound peak.

Alternatively, the average spectra over the entire peak may be used. **All subsequent tune evaluations must use the same procedure that was used for the Initial Calibration.**

If the criteria are not achieved, the analyst must retune the mass spectrometer and repeat the test until all criteria are met.

Analysis must not begin until the tuning criteria are met. The injection time of the acceptable tune analysis is considered the start of the 12-hour clock. The same mass spec settings must be used for the calibration standards and samples that were used for the tune evaluation standard. The exception being that the tune evaluation standard must be acquired in full scan mode and all others in SIM mode.

CONTROLLED COPY
DO NOT DUPLICATE

7.5.1.2 Internal Standard Calibration

A minimum 5-point calibration curve is created for the volatile organic compounds and surrogates using an internal standard technique. SGS Orlando routinely performs a 6-point calibration to maximize the calibration range.

Historically, many analytical methods have relied on linear models of the calibration relationship, where the instrument response is directly proportional to the amount of a target compound. The linear model has many advantages including simplicity and ease of use. However, given the advent of new detection techniques and because many methods cannot be optimized for all the analytes to which they may be applied, the analyst is increasingly likely to encounter situations where the linear model neither applies nor is appropriate. The option of using non-linear calibration may be necessary to address specific instrumental techniques. However, it is not EPA's intent to allow non-linear calibration to compensate for detector saturation or avoid proper instrument maintenance.

NOTE: Because of this concern, select programs including SC DHEC do not support the use of non-linear regressions.

The low point may be omitted from the calibration table for any compound with an LLOQ set at the level two standard. Additionally, the high point may be omitted for any compound that exhibits poor linearity at the upper end of the calibration range.

An entire level may be omitted provided that a minimum of 5 points remain. There must be technical justification to omit an entire level. This must be documented in the run log.

Response factors (RF) for each analyte are determined as follows:

$$RF = (A_{\text{analyte}} \times C_{\text{istd}}) / (A_{\text{istd}} \times C_{\text{analyte}})$$

A_{analyte} = area of the analyte
 A_{istd} = area of the internal standard
 C_{analyte} = concentration of the analyte
 C_{istd} = concentration of the internal standard.

The mean RF and standard deviation of the RF are determined for each analyte. The percent relative standard deviation (%RSD) of the response factors is calculated for each analyte as follows:

$$\%RSD = (\text{Standard Deviation of RF} \times 100) / \text{Mean RF}$$

If the %RSD \leq 15%, linearity through the origin can be assumed and the mean RF can be used to quantitate target analytes in the samples. Alternatively, a calibration curve of response vs. amount can be plotted. This method allows for the use of average response factors, linear regressions, and non-linear regressions. Linear regressions may be unweighted or weighted as $1/x$ or $1/x^2$. If the correlation coefficient (r) is ≥ 0.995 ($r^2 \geq 0.990$) then the curve can be used to quantitate target analytes in the samples. Regardless of which calibration model is chosen, the laboratory should visually inspect the curve plots to see how the individual calibration points compare to the plot.

Alternatively, either of the two techniques described below may be used to determine whether the calibration function meets acceptable criteria. These involve refitting the calibration data back to the model. Both % Error and Relative Standard Error (RSE) evaluate the difference between the measured and the true amounts or concentrations used to create the model.

Calculation of the % Error

$$\% \text{ ERR} = (x_i - x'_i) / x_i \cdot 100$$

x'_i = Measured amount of analyte at calibration level i , in mass or concentration units.

x_i = True amount of analyte at calibration level i , in mass or concentration units.

Percent error between the calculated and expected amounts of an analyte should be \leq 30% for all standards. For some data uses, $\leq 50\%$ may be acceptable for the lowest calibration point.

Calculation of Relative Standard Error (%RSE)

$$RSE = 100 \times \sqrt{\frac{\sum_{i=1}^n \left[\frac{x'_i - x_i}{x_i} \right]^2}{(n - p)}}$$

x'_i = Measured amount of analyte at calibration level i , in mass or concentration units.

x_i = True amount of analyte at calibration level i , in mass or concentration units.

p = Number of terms in the fitting equation.
(average = 1, linear = 2, quadratic = 3)

n = Number of calibration points.

The %RSE acceptance limit criterion is $\leq 15\%$ for good performing compounds and $\leq 30\%$ for poor performing (PP) compounds.

7.5.1.3 Initial Calibration Verification (ICV)

The validity of the initial calibration curve must be verified through the analysis of an initial calibration verification (ICV) standard. The ICV must be prepared from a second source at a mid-range concentration.

The %D for all analytes of interest should be $\leq 20\%$. If the %D $> 20\%$, the analysis of samples may still proceed if the analyte failed high and the analyte is not expected to be present in the samples. However, if a reportable analyte is detected in a sample and the %D for that analyte was greater than 20% in the ICV, the sample will need to be reanalyzed on a system with a passing ICV for that analyte.

NOTE: For any DoD QSM project, the %D for all target compounds should be $\leq 20\%$. If samples must be analyzed with an analyte of interest having a %D $> 20\%$, then the data must be qualified accordingly.

If the ICV does not meet criteria, a fresh standard must be prepared. If this ICV meets criteria, proceed with sample analysis. If the ICV still does not meet criteria, analyze an ICV prepared from a third source or different lot. Determine which two standards agree. Make fresh calibration standards and an ICV from the two sources that agree. Recalibrate the instrument.

7.5.2 Continuing Calibration Verification (CCV)

7.5.2.1 Inject 2ul of the tune evaluation mix at the beginning of each 12-hour shift. Evaluate the resultant peaks against the criteria in section 7.5.1.1. The injection time of this standard starts the 12-hour window.

When the analyst is running an unattended second 12-hour window, they may opt to purge the BFB standard. This can be performed by purging an additional blank (which contains BFB) just prior to the second CCV.

7.5.2.2 Analyze a continuing calibration check standard. The CCV must be at or below the mid-point of the calibration curve.

The percent difference (%D) for each analyte of interest will be monitored. The $|\%D|$ should be $\leq 20\%$ for each analyte.

If the first continuing calibration verification does not meet criteria, a second standard may be injected. If the second standard does not meet criteria, the system must be recalibrated. If the second standard meets

**CONTROLLED COPY
DO NOT DUPLICATE**

criteria then the system is considered in control and results may be reported.

Rationale for second standard such as instrument maintenance, clipped column, remade standard, etc must be documented in the run log or maintenance log. Reanalysis of second standard without valid rationale may require the analysis of a third standard (in which case both the second and third standard would have to pass).

NOTE: For any DoD QSM project, if the second standard meets criteria, then a third standard must be analyzed. If the third standard also meets criteria then the system is considered in control and results may be reported.

If the $|\%D|$ is greater than 20%, then documented corrective action is necessary. This may include recalibrating the instrument and reanalyzing the samples, performing instrument maintenance to correct the problem and reanalyzing the samples, or qualifying the data. Under certain circumstances, the data may be reported, i.e., the CCV failed high, the associated QC passed, and the samples were ND.

NOTE: For any DoD QSM project, if samples must be reported with a target analyte having a $\%D > 20\%$, then the data must be qualified accordingly, regardless of whether the analyte was detected or not.

NOTE: Any target analytes that are detected in the samples must have an acceptable initial calibration curve and acceptable CCV standards; otherwise, the samples must be reanalyzed, or the data must be qualified.

7.5.2.3 For DoD QSM 5.x compliance, an additional CCV must be analyzed at the end of each run. The closing CCV must be within the 12-hour Tune window.

The $\%D$ for all target compounds in this CCV should be $\leq 50\%$. If the $\%D > 50\%$ for any target compound, then the samples must be reanalyzed at least once at the appropriate dilution. If the $\%D > 50\%$ for the analytes in the reanalysis, the department supervisor shall review the data and determine what further action is necessary. This may include reanalyzing the samples at a higher dilution or qualifying the data.

NOTE: If samples are ND and an analyte in the CCV fails high, then the sample does not need to be reanalyzed.

7.5.2.4 If any of the internal standard area change by a factor of two (-50% to +100%) or retention time changes by more than 30 seconds (10 seconds for DOD QSM 5.x compliance) from the midpoint standard of the last initial calibration or from the daily CCV, the mass spectrometer must be inspected for malfunctions and corrections made, as appropriate.

**CONTROLLED COPY
DO NOT DUPLICATE**

Corrective action may include re-calibration (initial Calibration) of the instrument.

- 7.5.2.5 If any of the internal standard response changes by more than a factor of two (-50% to +100%) or retention time changes by more than 30 seconds (10 seconds for DOD QSM 5.x compliance) from the midpoint standard of the last initial calibration or from the daily CCV, the mass spectrometer must be inspected for malfunctions and corrections made, as appropriate. Corrective action may include re-calibration (initial calibration) of the instrument

7.5.3 Sample Analysis

- 7.5.3.1 Samples are analyzed in a set referred to as an analysis sequence or batch. A batch consists of the following:

Tune Evaluation Mix
Initial Calibration Standards (or CCV)
QC Samples
Samples

- 7.5.3.2 One microliter (OI) or five microliter (EST) of internal standard/surrogate solution is added to every 5ml of sample in the sparge vessel. Generally, 5ml of sample are transferred to the sparge vessel.

- 7.5.3.3 After purging, the system will automatically reverse flow and rapidly heat the trap to desorb the sample analytes onto the GC column.

- 7.5.3.4 Qualitative identification

The target compounds shall be identified by analysts with competent knowledge in the interpretation of mass spectra by comparison of the sample mass spectrum to the mass spectrum of a standard of the suspected compound. The criteria required for a positive identification are:

The intensities of the characteristic ions of a compound maximize in the same scan or within one scan of each other. Selection of a peak by a data system target compound search routine where the search is based on the presence of a target chromatographic peak containing ions specific for the target compound at a compound-specific retention time will be accepted as meeting this criterion.

The sample component must elute at the same relative retention time (RRT) as the daily standard. The RRT of sample component must be within ± 0.06 RRT units of the standard.

All ions monitored in the standard mass spectra must be present in the sample spectrum.

CONTROLLED COPY
DO NOT DUPLICATE

The relative intensities of these ions must agree within $\pm 30\%$ between the daily standard and sample spectra, (e.g., for an ion with an abundance of 50% in the standard spectra, the corresponding sample abundance must be between 20 and 80%).

Structural isomers that produce very similar mass spectra must be identified as individual isomers if they have sufficiently different GC retention times. Sufficient GC resolution is achieved if the height of the valley between two isomer peaks is less than 25% of sum of the two peak heights. Otherwise, structural isomers are identified as isomeric pairs.

If peak identification is prevented by the presence of interferences, the sample must be diluted so that the interference does not mask any analytes.

7.5.3.5 Quantitative analysis

When a target compound has been identified, concentration will be based on the integrated area of the quantitation ion, which is normally the base peak.

The sample matrix may produce an interference with the primary ion. This may be characterized by an excessive background signal of the same ion, which distorts the peak shape beyond a definitive integration. The interference could also, severely inhibit the response of the internal standard ion.

If the analyte response exceeds the linear range of the system, the extract must be diluted and reanalyzed. It is recommended that samples be diluted so that the response falls into the middle of the calibration curve.

7.6 Maintenance and Trouble Shooting

7.6.4 Refer to SOP GC001 for routine instrument maintenance and trouble shooting.

7.6.5 All instrument maintenance must be documented in the appropriate "Instrument Repair and Maintenance" log. The log will include such items as problem, action taken, correction verification, date, and analyst.

7.6.6 Repairs performed by outside vendors must also be documented in the log. The analyst or Department Supervisor responsible for the instrument must complete the log if the repair technician does not.

7.6.7 PC and software changes must be documented in the "Instrument Repair and Maintenance" log. Software changes may require additional validation.

8.0 METHOD PERFORMANCE

Method performance is monitored through the routine analysis of negative and positive control samples. These control samples include method blanks (MB), blank spikes (BS), matrix spikes (MS), and matrix spike duplicates (MSD). The MB and BS are used to monitor overall method performance, while the MS and MSD are used to evaluate the method performance in a specific sample matrix.

Blank spike, matrix spike, and matrix spike duplicate samples are compared to statistically generated control limits. These control limits are reviewed and updated annually. Control limits are stored in the LIMS. Additionally, blank spike accuracy is regularly evaluated for statistical trends that may be indicative of systematic analytical errors.

9.0 QUALITY ASSURANCE / QUALITY CONTROL

Accuracy and matrix bias are monitored by the use of surrogates and by the analysis of a QC set that is prepared with each batch (maximum of 20 samples) of samples. The QC set consists of a method blank (MB), blank spike (BS), matrix spike (MS), and matrix spike duplicate (MSD).

9.1 Internal Standards

9.1.1 Fluorobenzene, chlorobenzene-d₅, 1,4-dichlorobenzene-d₄, and 1,4-dioxane-d₈ may be used as the internal standards for this method. The response of the internal standard in all subsequent runs must be within a factor of two (-50% to +100%) of the internal standard response in the opening CCV for each sequence. On days that an initial calibration is performed, the internal standard response must be compared to the internal standard response for the mid-point standard.

9.1.2 If the internal standard response is not within limits, the following are required.

9.1.2.1 Check to be sure that there are no errors in calculations, integrations, or internal standards solutions. If errors are found, recalculate the data accordingly.

9.1.2.2 Check instrument performance. If an instrument performance problem is identified, correct the problem and reanalyze the sample. If the recovery is high due to interfering peaks, it may be possible to get a more accurate recovery by analyzing the sample on a different column type.

9.1.1.3 If no problem is found, prepare a second aliquot of sample and reanalyze the sample. If there is insufficient sample for reanalysis, footnote this on the report.

9.1.1.4 If upon reanalysis, the responses are still not within limits, the problem is considered matrix interference. The sample may need to be diluted or the results qualified.

CONTROLLED COPY
DO NOT DUPLICATE

9.2 Surrogates

- 9.2.1 Dibromofluoromethane, 1,2-dichloroethane-d₄ and toluene-d₈ may be used as the surrogate standards to monitor the efficiency of the purge-and-trap system.

A known amount of surrogate standard is added to each sample including the QC set prior to purging. The percent recovery for each surrogate is calculated as follows:

$$\% \text{ Recovery} = (\text{Sample Amount} / \text{Amount Spiked}) \times 100$$

The percent recovery must fall within the established control limits for all surrogates for the results to be acceptable.

- 9.2.2 If any surrogate recovery is not within the established control limits, the following are required.

9.2.2.1 Check to be sure that there are no errors in calculations, dilutions, integrations, surrogate solutions or internal standard solutions. If errors are found, recalculate the data accordingly.

9.2.2.2 Check instrument performance. If an instrument performance problem is identified, correct the problem and reanalyze the sample. If the recovery is high due to interfering peaks, it may be possible to get a more accurate recovery by analyzing the sample on a different column type.

9.2.2.3 If no problem is found, reanalyze the sample. **NOTE:** If the recoveries are high and the sample is non-detect, then reanalysis may not be necessary. For any DoD QSM projects, the resulting data must be qualified accordingly. If there is insufficient sample for reanalysis, footnote this on the report.

9.2.2.4 If upon reanalysis, the recovery is still not within control limits, the problem is considered matrix interference. Surrogates from both sets of analysis must be reported on the final report.

9.3 Method Blank

- 9.3.1 The method blank is de-ionized water or de-ionized water with 5 grams of clean sand (depending upon sample matrix) to which the surrogate standard has been added. An appropriate aliquot of methanol must also be added. The method blank is then purged along with the other samples to determine any contamination from the system or ambient sources. The method blank must be free of any analytes of interest or interferences at ½ the required LLOQ level to be acceptable. Common laboratory contaminants such as methylene chloride must be below the LLOQ if present. Samples associated with a contaminated method blank shall be

evaluated as to the best corrective action for each particular sample. This may include reanalyzing the samples or qualifying the results with a "B" or "V" qualifier.

- 9.3.2 If the MB is contaminated but the samples are non-detect, then the source of contamination must be investigated and documented. The sample results can be reported. **For any DoD QSM projects the resulting data must be qualified accordingly.**
- 9.3.3 If the MB is contaminated but the samples results are > 10 times the contamination level, the source of the contamination must be investigated and documented. The samples results may be reported with the appropriate "B" or "V" qualifier. This must be approved by the department supervisor.
- 9.3.4 If the MB is contaminated but the samples results are < 10 times the contamination level, the source of the contamination must be investigated and documented. The samples must be reanalyzed for confirmation. If there is insufficient sample to reanalyze, or if the sample is reanalyzed beyond hold time, the appropriate footnote and qualifiers must be added to the results. This must be approved by the department supervisor.

9.4 Blank Spike

- 9.4.1 The blank spike is de-ionized water or de-ionized water with 5 grams of clean sand (depending upon sample matrix) to which the surrogate standard and spike standard have been added. An appropriate aliquot of methanol must also be added. The blank spike is then processed along with the other samples to monitor the efficiency of the purge-and-trap procedure. The percent recovery for each analyte is calculated as follows:

$$\% \text{ Recovery} = (\text{Blank Spike Amount} / \text{Amount Spiked}) \times 100$$

The percent recovery for each analyte of interest must fall within the established control limits for the results to be acceptable.

NOTE: A secondary check against 70-130% limits must be performed for all analytes reported to SC DHEC.

- 9.4.2 If the blank spike recoveries are not within the established control limits, the following are required.
 - 9.4.2.1 Check to be sure that there are no errors in calculations, dilutions, integrations, spike solutions, or internal standard solutions. If errors are found, recalculate the data accordingly.
 - 9.4.2.2 Check instrument performance. If an instrument performance problem is identified, correct the problem and reanalyze the sample.

- 9.4.2.3 If the recovery of an analyte in the BS is high and the associated sample is non-detect, the data may be reportable. For any DoD QSM projects, the resulting data must be qualified accordingly.
- 9.4.2.4 If no problem is found, the department supervisor shall review the data and determine what further corrective action is best for each particular sample. That may include reanalyzing the samples or qualifying the results as estimated.
- 9.4.2.5 If there is insufficient sample to reanalyze, or if the sample is reanalyzed beyond hold time, the appropriate footnote and qualifiers must be added to the results. This must be approved by the department supervisor.

9.5 Matrix Spike and Matrix Spike Duplicate

- 9.5.1 Matrix spike and spike duplicates are replicate sample aliquots to which the surrogate standard and spike standard have been added. The matrix spike and spike duplicate are then processed along with the other samples to monitor the precision and accuracy of the purge-and-trap procedure. The percent recovery for each analyte is calculated as follows:

$$\% \text{ Recovery} = ([\text{Spike Amount} - \text{Sample Amount}] / \text{Amount Spiked}) \times 100$$

The percent recovery for each analyte of interest must fall within the established control limits for the results to be acceptable.

- 9.5.2 If the matrix spike recoveries are not within the established control limits, the following are required.
 - 9.5.2.1 Check to be sure that there are no errors in calculations, dilutions, integrations, spike solutions, or internal standard solutions. If errors are found, recalculate the data accordingly.
 - 9.5.2.2 Check instrument performance. If an instrument performance problem is identified, correct the problem and reanalyze the sample. If the recovery is high due to interfering peaks, it may be possible to get a more accurate recovery by analyzing the sample on a different column type.
 - 9.5.2.3 If no problem is found, compare the recoveries to those of the blank spike. If the blank spike recoveries indicate that the problem is sample related, document this on the run narrative. Matrix spike recovery failures are not grounds for reanalysis, but are an indication of the sample matrix effects.

9.5.3 Precision

Matrix spike and spike duplicate recoveries for each analyte are used to calculate the relative percent difference (RPD) for each compound.

$$\text{RPD} = (| \text{MS Result} - \text{MSD Result} | / \text{Average Result}) \times 100$$

The RPD for each analyte should fall within the established control limits. If the RPDs fall outside of the established control limits, the department supervisor shall review the data and determine if any corrective action is necessary. RPD failures are generally not grounds for batch reanalysis.

10.0 CALCULATIONS

The concentration of each target compound in the original sample is calculated as follows:

$$\text{Water (ug/l)} = (\text{CONC}_{\text{inst}}) \times \text{DF}$$

$$\text{Soil (ug/kg)} = [(\text{CONC}_{\text{inst}}) \times (5 / W_1)] / \% \text{solids (low level soils)}$$

$$\text{Soil (ug/kg)} = [(\text{CONC}_{\text{inst}}) \times (V_F / V_A) \times (5 / W_1) \times \text{DF}] / \% \text{solids (high level soils)}$$

CONC _{inst}	=	Instrument concentration calculated from the initial calibration using mean RF or curve fit.
DF	=	Dilution Factor
V _F	=	Volume of methanol extract (ul)
V _A	=	Volume of methanol aliquot (ul)
W ₁	=	Weight of sample (g)
%solids	=	Dry weight determination in decimal form

For high level soils, V_F is calculated as follows:

$$V_F = \{ \text{ml of solvent} + [(\% \text{moisture} \times W_1) / 100] \} \times 1000 \text{ ul/ml}$$

11.0 SAFETY AND POLLUTION PREVENTION

11.1 Safety

The analyst must follow normal safety procedures as outlined in the SGS Health and Safety Program, which includes the use of safety glasses, gloves, and lab coats.

The toxicity of each reagent and target analyte has not been precisely defined; however, each reagent and sample must be treated as a potential health hazard. Material Safety Data Sheets (MSDS) or Safety Data Sheets (SDS) are available for all reagents and many of the target analytes. Exposure must be reduced to the lowest possible level. Personal protective equipment must be used by all analysts.

11.2 Pollution Prevention

Waste solvents from the sample analysis, methanol extraction, and standards preparation are collected in waste storage bottles and are eventually transferred to the non-chlorinated waste drum.

Old stock standards are disposed of in the waste vial drum.

Dilution waste and purged aqueous samples and standards are rinsed down the drain with large amounts of water.

Samples are archived and stored for 30 days after analysis. After the storage time has elapsed, the remaining aqueous and soil samples are transferred to the appropriate drums for disposal.

12.0 REFERENCES

SW846 Method 8000D Revision 4, July 2014

SW846 Method 8260B Revision 2, December 1996

SW846 Method 8260D Revision 4, June 2018

TABLE 1

Routine Target Analytes

Benzene	cis-1,3-Dichloropropene
Carbon Tetrachloride	trans-1,3-Dichloropropene
Chloroform	1,4-Dioxane
1,1-Dichloroethane	Methyl Chloride
1,2-Dichloroethane	Methylene Chloride
1,1-Dichloroethylene	Tetrachloroethylene
cis-1,2-Dichloroethylene	1,1,1-Trichloroethane
trans-1,2-Dichloroethylene	Trichloroethylene
1,2-Dichloropropane	Vinyl Chloride

TABLE 2

Characteristic Ions

Analyte	Quant. Ion	Q1	Q2	Q3
Fluorobenzene IS	96	70		
Methyl Chloride	50	52		
Vinyl Chloride	62	64		
1,1-Dichloroethene	61	96	98	63
Methylene Chloride	49	84	86	51
trans-1,2-Dichloroethene	61	96	98	63
1,1-Dichloroethane	63	65		
cis-1,2-Dichloroethene	96	61	98	63
Chloroform	83	85	47	
Dibromofluoromethane Surr	113	111	192	
Carbon Tetrachloride	117	119	121	82
1,1,1-Trichloroethane	97	99	61	
Benzene	78	51		
1,2-Dichloroethane-d4 Surr	65	67	102	
1,2-Dichloroethane	62	49	64	
Trichloroethene	95	130	97	132
1,2-Dichloropropane	63	62	41	76
cis-1,3-Dichloropropene	75	77	39	
Chlorobenzene-d5 IS	117	82		
Toluene-d8 Surr	98	100		
trans-1,3-Dichloropropene	75	77	39	49
Tetrachloroethene	166	164	129	131
1,1,2-Trichloroethane	83	97	61	99
1,4-Dioxane-d8 IS	96	64		
1,4-Dioxane	88	58	43	



METALS BY INDUCTIVELY COUPLED PLASMA ATOMIC EMISSION SPECTROMETRY (ICP)

Prepared by: David Metzgar III Date: 12/18/2020

Approved by: Svetlana Izosimova Date: 12/18/2020

Annual Review

Reviewed by: _____ Date: _____

Reviewed by: _____ Date: _____

Reviewed by: _____ Date: _____

Document Control

Issued to: QA Department Date: 12/18/2020

Issued to: Metals Date: * 12/18/2020

Issued to: _____ Date: _____

Issued to: _____ Date: _____

Issued to: _____ Date: _____

Issued to: _____ Date: _____

Effective 7 days after "*" date

**CONTROLLED COPY
 DO NOT DUPLICATE**

TITLE: METALS BY INDUCTIVELY COUPLED PLASMA ATOMIC EMISSION SPECTROMETRY (ICP)

REFERENCES: SW846 6010D, 2014

INSTRUMENT: THERMO 6500, SERIAL # 20100903 SSTRACE 1

INSTRUMENT: THERMO 6500, SERIAL # 20103825 SSTRACE 2

AUTOSAMPLER: CETAC 240 POSITION, SERIAL # 031038A520 SSTRACE 1

AUTOSAMPLER: CETAC 240 POSITION, SERIAL # 041048A520 SSTRACE 2

SUGGESTED WAVELENGTH (S): TABLE 2

1.0 SCOPE AND APPLICATION SUMMARY

SW-846 methods, with the exception of required method use for the analysis of method-defined parameters, are intended to be guidance methods which contain general information on how to perform an analytical procedure or technique which a laboratory can use as a basic starting point for generating its own detailed Standard Operating Procedure (SOP), either for its own general use or for a specific project application. The performance data included in this method are for guidance purposes only, and are not intended to be and must not be used as absolute QC acceptance criteria for purposes of laboratory accreditation.

- 1.1 This method is applicable for the determination of metals in water, sludges, sediments, and soils. Elements that can be reported by this method include: Aluminum, Antimony, Arsenic, Barium, Beryllium, Cadmium, Calcium, Chromium, Cobalt, Copper, Iron, Lead, Magnesium, Manganese, Molybdenum, Nickel, Potassium, Selenium, Silver, Sodium, Strontium, Titanium, Thallium, Tin, Vanadium, and Zinc.
- 1.2 Sample matrices are pretreated following SW846 and EPA methods for digestion of soil, sediment, sludge or water samples. Refer to specific metals department digestion SOP's for more information on digestion techniques.
- 1.3 This inductively coupled argon plasma optical emission spectrometer (s) (ICP-OES) uses an Echelle optical design and a Charge Injection Device (CID) solid-state detector to provide elemental analysis. Control of the spectrometer is provided by PC based iTEVA software. In the instrument, digested samples are introduced into the Thermo 6500 ICP, passed through a nebulizer and transported to a plasma torch. The element-specific emission spectra are produced by a radio frequency inductively coupled plasma. The spectra are dispersed by a spectrometer, and the intensities of the emission lines are monitored with the solid state detector.
- 1.4 Reporting limits (RL)(LLOQ) are based on the extraction procedure. Reporting limits may vary depending on matrix complications, volumes and by client needs, but the reporting limits must always be verified with a low check which meets the criteria outlined in this SOP. Solid matrices are reported on a dry weight basis. Refer to table 1 of this SOP for

**CONTROLLED COPY
DO NOT DUPLICATE**

SGS - Orlando typical reporting limits. Refer to scheduling sheets and/or project specific QAPP for further information regarding client specific reporting limits.

- 1.5 MDLs must be established for all analytes, using a solution spiked at approximately 3 to 5 times the estimated detection limit. To determine the MDL values, take seven replicate aliquots of the spiked sample and process through the entire analytical method. The MDL is calculated by multiplying the standard deviation of the replicate analyses by 3.14, which is the student's t value for a 99% confidence level. MDLs must be determined approximately once per year for each matrix and instrument. Please refer to SGS - Orlando QA SOP QA020, current version for further information regarding method performance criteria and experimental method detection limits.

MDLs are generated for each matrix on both ICP instruments. The higher of the two statistically calculated MDL's is entered into LIMS as the MDL. The verified MDLs are stored in the LIMS and must be at least 2 to 3 times lower than the RL. Exceptions may be made on a case by case basis; however, at no point shall the MDL be higher than the reported RL.

- 1.6 LLOQ verification. LLOQ is the lowest point of quantitation. The LLOQ is initially verified by the analysis of 7 replicate samples, spiked at the LLOQ and processed through all preparation and analysis steps of the method. The mean recovery should be within +/- 35 percent of the true value with an RSD \leq 20 percent.
- 1.7 Ongoing Lower limit of quantitation (LLOQ) check sample. The lower limit of quantitation check sample should be analyzed on a quarterly basis to demonstrate the desired detection capability. The LLOQ sample is carried through the entire preparation and analytical procedure. The mean recovery should be within +/- 35 percent of the true value with an RSD \leq 20 percent.
- 1.8 Compounds detected at concentrations between the RL and MDL are quantitated and qualified as estimated values and reported with either a "J" or "I" qualifier. Some program or project specifications may require that no values below the RL be reported.
- 1.9 Instrument Detection Limits (IDL). It is suggested that IDL's be completed upon initial instrument installation, whenever instrument conditions have significantly changed, or at a minimum annually. Instrument detection limits can be estimated as the mean of the blank results plus 3 times the standard deviation of 10 replicate analyses of the reagent blank solution. (use zero for the mean if the mean is negative) Each IDL measurement shall be performed as though it were a separate analytical sample. IDLs shall be determined and reported for each wavelength used in the analysis of the samples.

2.0 PRESERVATION AND BOTTLEWARE

All samples should be preserved with nitric acid to a pH of <2 at the time of collection. All sample pH are checked in sample receiving and within the metals department. Samples that are received with a pH >2 must be preserved to pH <2 and held for 24 hours prior to metals digestion to dissolve any metals that absorb to the container walls. Refer to SOP SAM101, current revision for further instruction. Final pH of TCLP extracts are checked and recorded in SGS - Orlando

CONTROLLED COPY
DO NOT DUPLICATE

Extractions Department. Please refer to TCLP (1311) fluid determination logbook and SPLP (1312) fluid determination logbook for further information. TCLP extracts received from SGS - Orlando Extractions Department are prepared as soon as possible, no longer than 24 hours from time of receipt. If precipitation is observed during the sample preparation process the sample(s) are immediately re-prepped on dilution until no precipitation is observed. Samples received for dissolved metals analysis should be filtered and preserved to pH<2 as soon as possible and held for 24 hours prior to digestion. Refer to SGS - Orlando Sample Filtration Logbook for further information.

All soil samples must be stored in a refrigerator at $\leq 6^{\circ}\text{C}$ upon receipt. Refer to SOP SAM101, current revision for further instruction.

All bottleware used by SGS - Orlando is tested for cleanliness prior to shipping to clients. Analysis results must be less than one half the reporting limit (LLOQ) to be acceptable. Refer to SOP SAM104, current revision for further instruction.

3.0 HOLDING TIME AND BATCH SIZE

All samples must be prepared and analyzed within 6 months of the date of collection. Refer to appropriate SGS - Orlando digestion SOP, current revision for batch size criteria.

4.0 INTERFERENCES

Several types of interferences can cause inaccuracies in trace metals determinations by ICP. These interferences are discussed below.

4.1 Spectral interferences are caused by overlap of a spectral line from another element, unresolved overlap of molecular band spectra, background contribution from continuous or recombination phenomena, and background contribution from stray light from the line emission of high concentration elements. Corrections for these interferences can be made by using interfering element corrections, by choosing an alternate analytical line, and/or by applying background correction points. The locations selected for the measurement of background intensity will be determined by the complexity of the spectrum adjacent to the wavelength peak. The locations used for routine measurement must be free of off-line spectral interference or adequately corrected to reflect the same change in background intensity as occurs at the wavelength peak.

Note: Refer to section 17.0 of this SOP for further instruction regarding interfering element correction factor generation.

4.2 Physical interferences can be caused by changes in sample viscosity or surface tension, by high acid content in a sample, or by high dissolved solids in a sample. These interferences can be reduced by making sample dilutions.

4.3 Matrix interferences in high solid samples can be overcome by using an internal standard. Yttrium/Indium mix is used for the Thermo 6500 ICP. The concentration must be sufficient for optimum precision but not so high as to alter the salt concentration of the matrix. The

CONTROLLED COPY
DO NOT DUPLICATE

element intensity is used by the instrument as an internal standard to ratio the analyte intensity signals for both calibration and quantitation.

- 4.4 Chemical interferences are not pronounced with ICP due to the high temperature of the plasma, however if they are present, they can be reduced by optimizing the analytical conditions (i.e. power level, torch height, etc.).

5.0 APPARATUS

- 5.1 Currently there are two solid state ICPs available for use in the lab. Both are Thermo 6500 ICP units. These units have been optimized to obtain lower detection limits for a wide range of elements. Since they are solid state systems, different lines may be included for elements to obtain the best analytical results. However, the lines which are normally included in the normal analysis program are shown in Table 2.
- 5.2 Instrument auto samplers. For random access during sample analysis.
- 5.3 Class A volumetric glassware and pipettes.
- 5.4 Polypropylene auto sampler tubes.
- 5.5 Eppendorf Pipette (s) - Pipette (s) are checked daily for accuracy and to ensure they are in good working condition prior to use. Volumes are checked at 100% of maximum volume (nominal volume). Pipettes are checked within the metals department and results are stored electronically in the "Pipette Calibration Log". Refer to SOP QA006, current revision for further information regarding pipette calibration. BIAS: mean must be within 2% of nominal volume. Precision: RSD must be $\leq 1\%$ of nominal volume based on three replicates.
- 5.6 Fisher Brand 0.45 micron (um) filter or equivalent. Filter lots are checked for cleanliness through the Method Blank process. All Method Blank analytical results must be less than one half the reporting limit(LLOQ) to be acceptable, if not, the contaminated lot must be identified and removed from laboratory use. Samples filtered through the contaminated filters must be re-filtered through acceptable filters.
- 5.7 Fisher Brand disposable 10 ml syringes or equivalent. Syringe lots are checked for cleanliness through the Method Blank process. All Method Blank results must be less than one half the reporting limit (LLOQ) to be acceptable, if not, the contaminated lot must be identified and removed from laboratory use. Samples filtered through the contaminated syringes must be re-filtered through acceptable syringes.
- 5.8 Data System

Microsoft Windows XP Professional Version 2002
Instrument software SST1 – Thermo iTEVA version 2.8.0.89
Instrument software SST2 – Thermo iTEVA version 2.7.0.87

- 5.8.1 A computer system interfaced to the Thermo 6500 ICP that allows for the continuous acquisition and storage of all data obtained throughout the duration of the analytical run sequence.
- 5.8.2 Data is archived to a backup server for long term storage.

6.0 REAGENTS

All chemicals listed below are trace metal grade unless otherwise specified. Refer to Acid Certificate of Analysis logbook for Certificates of Analysis and compliance with the specifications of the grade listed. SGS - Orlando produces DI water to the specifications for the ASTM Type II standard designation based on the system manufacturer's performance specifications. The DI water is used exclusively for laboratory purposes. De-ionized (DI) water should be used whenever water is required. Refer to SOP QA037, current revision for more information regarding testing and monitoring. Refer to the Metals Department Standard Prep Logbook for the make-up and concentrations of standards and stock solutions being used within this SOP. Some of the information included in the logbook is as follows: standard name, elements in mix, manufacturer, lot number, parent expiration date, acid matrix, stock concentration, volume of standard added, total volume, final prepared concentration, prep date, initials, MET number, and prepared standard expiration date. Standards and prepared reagents must be prepared every 6 months or before stock standard expiration date, whichever comes first. Refer to tables 3 through 7 of this SOP for concentration levels of standards used. Unless otherwise approved, the calibration curve must contain 3 points determined by a blank and a series of standards representing the elements of interest.

- 6.1 2.5 ppm Yttrium and 10 ppm Indium internal standard, made from ICP quality standard.
- 6.2 Hydrochloric acid, trace metals grade.
- 6.3 Nitric Acid, trace metals grade.
- 6.4 ICP quality standard stock solutions are available from Inorganic Ventures, Spex, Plasma Pure, Ultra, Environmental Express, or equivalent.
- 6.5 Calibration Standards. These can be made up by diluting the stock solutions to the appropriate concentrations. The calibration standards should be prepared using the same type of acid (s) and at approximately the same concentration as will result in the samples following sample preparation.
 - 6.5.1 For calibration and quantitation an internal standard (Yttrium/Indium) is used to limit nebulization problems. If it is known that the samples contain a significantly different acid matrix, the samples must be diluted so that they are in a similar matrix to the curve. All sample results are referenced to the initial calibration blank (ICB) Internal Standard counts. The criteria is 60-125 percent of the initial calibration blank (ICB) counts. If the internal standard counts fall outside these criteria matrix effects must be suspected and the sample diluted until it meets the criteria or footnoted in LIMS as suspected matrix interference.

6.5.2 Standards must be prepared so that there is minimal spectral interference between analytes.

Note: All Ag stock and intermediate solutions must be stored away from direct sunlight.

6.6 Analytical Quality Control Solutions.

All of the solutions below are prepared by adding either mixed or single element metals solutions to a solution prepared using the same type of acid (s) and at approximately the same concentration as will result in the samples following sample preparation.

6.6.1 Blank (Calibration, ICB, CCB)

This reagent blank contains Nitric Acid at 3 percent and Hydrochloric Acid at 5 percent.

6.6.2 Initial Calibration Verification solution.

This standard solution must be made from a different source than the calibration curve. The concentrations for each element must be within the range of the calibration curve and should be approximately at the midpoint of the curve. This solution is used to verify the accuracy of the initial calibration. Levels for the ICV standard are shown in Table 4.

6.6.3 Continuing Calibration Verification solution.

The metals concentrations for this standard should be at approximately the mid-point of the calibration curve for each element. This standard should be prepared from the same source that is used for the calibration curve. Levels for the CCV standard are shown in Table 5.

6.6.4 Spectral Interference Checks (SIC). Two types of SIC checks are used. Individual element SIC are performed when the instrument is initially set up, and every six months thereafter. The mixed element SIC solution is used daily to check that the instrument is free from interference from elements typically observed in high concentration and to check that interference corrections (IEC) are still valid.

6.6.4.1 Single element interference checks – At a minimum, single element SIC checks should be performed for the following elements: Aluminum 500 mg/l; Barium 4 mg/l; Calcium 500 mg/l; Copper 4 mg/l; Iron 500 mg/l; Magnesium 500 mg/l; Manganese 4 mg/l; Molybdenum 4 mg/l; Sodium 1000 mg/l; Nickel 4 mg/l; Selenium 4 mg/l; Silicon 50 mg/l; Tin 4 mg/l; Vanadium 4 mg/l and Zn 4 mg/l.

Mixed element SIC solution – The mixed element SIC solution is used as an ongoing daily check of freedom from spectral interferences. The mixed element SIC contains the following elements: Aluminum 500 mg/l; Calcium 500 mg/l; Iron 200 mg/l; Magnesium 500 mg/l.

The absolute value of the concentration observed for any unspiked analyte in the single element SIC checks must be less than 2 times the analytes LLOQ. The concentration of the SIC checks are suggested, but become the highest reportable concentration in the sample analysis and cannot be higher than the highest established linear range. Samples with concentrations of elements higher than the SIC check must be diluted until the concentration is less than the SIC check solution. Reanalysis of a diluted sample is required even if the high concentration element is not required to be reported for the specific sample, since the function of the SIC check is to evaluate spectral interferences on other elements. The daily mixed element SIC solution is analyzed daily after calibration. The concentration measured for any target analytes must be less than +/- the LLOQ. For spiked elements, the analyzed results must be within 20 percent of the true value for SIC check and within 10 percent for linear range check. If this criterion cannot be met then sample analysis may not proceed until the problem is corrected, or the LLOQ is raised to twice the concentration observed in the SIC solution. The only exceptions are those elements that have been demonstrated and documented as contaminants in the SIC solutions. Levels for the SIC and mixed SIC can be found on tables 9 and 10.

6.7 CRIA Standard Solution (Also referred to as LLCCV)

The CRIA standard contains the elements of interest at levels equal to SGS - Orlando quantitation limits (RL). Please refer to Table 6 for list of elements of interest and concentration levels for the CRIA. If special client reporting limits are requested, then low checks corresponding to those reporting limits must also be analyzed.

6.8 Matrix Spike, Matrix Spike duplicate, and Spike Blank Solution.

This solution is prepared by adding either mixed or single element metals solutions to a solution containing 3 percent nitric acid and 5 percent hydrochloric acid and diluting to a fixed final volume with this acid mixture. Spiking solution (s) must be added to the spike blank, matrix spike, and the matrix spike duplicate prior to digestion. Levels for the MS and MSD and Spike Blank standard are shown in Table 7.

6.9 Liquid Argon or Argon Gas. (99.999% purity)

7.0 ANALYTICAL PROCEDURE

Note: Please refer to section 8 of this SOP for further detail on quality control standards. Please refer to scheduling sheets and/or project specific QAPP for further information regarding client specific QC requirements.

CONTROLLED COPY
DO NOT DUPLICATE

- 7.1 General procedure on how to operate the Thermo 6500 is described below. Refer to the Thermo 6500 operation manual for further details.
- 7.2 Before starting up the instrument, make sure that the pump tubing is in good condition, the torch assembly, the nebulizer, and the spray chamber are clean, the dehumidifier (if used) is filled with DI water up to the level between Minimum and Maximum, and that there are no leaks in the torch area.
- 7.3 Turn on the recirculating cooler. Verify that the argon is turned on and there is enough for the entire days analytical run.
- 7.4 Tighten the pump platens and engage the peristaltic pump. Make sure sample and internal standard solutions are flowing smoothly.
- 7.5 Put a new solution of acid rinse into the rinse reservoir. The composition of the rinse solution may be periodically changed to minimize sample introduction problems and sample carryover. If internal standard is being used, make sure that sufficient amount of internal standard is prepared for the entire analytical run.
- 7.6 Start up the instrument following the sequence show below.
 - 7.6.1 Double click the **iTEVA Control Center** Icon on the desktop. Type **admin** in User Name field, and then click **OK**.
 - 7.6.2 Once the iTEVA Control Center window is opened, click on **Plasma** Icon at status bar area. Then click on **Instrument Status** to check the interlock indicators (torch compartment, purge gas supply, plasma gas supply, water flow and exhaust should be in green; drain flow and busy should be in gray) and the Optics Temperature. (It should be around 38°C.) Click on the Close box.
 - 7.6.3 Click **Plasma On**. When the plasma is on, click close. Let the instrument warm up for 15 to 20 minutes before starting the analysis. New tubing may take an hour to stabilize.
- 7.7 Torch Alignment and Auto Peak
 - 7.7.1 If the torch has been cleaned, then the torch alignment procedure must be performed.
 - 7.7.2 Open the method and then click on **Sequence** tab, then click on **List View** Icon until you reach rack display.
 - 7.7.3 Go to S-6 position (you can assign any position in the rack for torch alignment), then right click to select **Go** to empty sample S:6. (Now, the auto sampler tip moves from Rinse to this position).
 - 7.7.4 Click on **Analysis** tab, then select **Torch Alignment** from Instrument drop down menu. There will be a pop up dialog box present. Click **Run**. Then there will be another dialog pop up box (This is a reminder for Torch Alignment Solution (2 ppm Zn)), click **Ok**. Now, the instrument is initializing an automated torch alignment. It

takes about 7 minutes to complete this step. Progress is indicated in the progress bar.

- 7.7.5 After torch alignment is complete, click **Close**. Click on **Sequence** tab, then followed by **List View** Icon.
 - 7.7.6 Go to Rinse position at rack display, right click to select Go to rinse and let it rinse for approximately 5 minutes.
 - 7.7.7 Perform Auto Peak
 - 7.7.8 It is recommended that the Auto Peak Adjust procedure be performed daily prior to calibration. A standard that contains all of the lines of interest is used and the system automatically makes the appropriate fine adjustments. (High standard solution should be used for this process.)
 - 7.7.9 Click **Sequence** tab, then click on **List View** Icon until the rack is displayed.
 - 7.7.10 Go to S-5 position (you can assign any position in the rack for auto peak adjust), then right click to select **Go** to empty sample S:5. (Now, the auto sampler tip moves from the Rinse position to this position). Click on **Analysis** tab. All elements result is shown in the display area. From Instrument drop down menu, select **Perform Auto Peak**. There will be a pop up dialog box present. Highlight "All Elements", and then click **Run**. Then there will another pop up dialog box (This is a reminder for Auto Peak Solution), click **Ok**. Now, the instrument is performing auto peak adjust. It takes about 5 minutes to complete this process. The Auto Peak dialog box will show a green check mark in front of "All Elements", which indicates Auto Peak is complete.
- 7.8 Open the method and start up the run.
- 7.8.1 Click on **Analyst** Icon at the workspace. Go to the method and choose Open from the drop down menu. Select the method with the latest revision number.
 - 7.8.2 Go to **Method** tab at the bottom of left hand corner to click on **Automated Output** at the workspace area. Type a filename in Filename field in the data display area (i.e. : SA101010M1, starts with SA, then followed by MM-DD-YY, then M1; M1 indicates the first analytical run for that day, then followed by M2, M3 and so on for the second and third runs.) Click on **Apply To All Sample Types**.
 - 7.8.3 Click on **Sequence** tab at the bottom of left hand corner. From Auto Session drop down menu bar, click on **New Auto sampler** to create a sequence. This will pop up a dialog box, then click on **New** and fill in number of samples (i.e.: 100) in the Number of Samples field and the sample I.D. (leave this field empty) in Sample Name field. Type a sequence name (i.e. : SEQ101010M1, starts with SEQ, then MM-DD-YY, then M1; M1 indicates the first analytical run for that day, then followed by M2, M3 and so on for the second and third runs) in the Sequence Name field. Click Ok, then put in "0" as settle time between sequences, and click **Ok**.

- 7.8.4 Right click on **Untitled** (Cetac ASX-520 Enviro 5 Named Rack is the rack that is currently used) at the workspace area, click on **Auto-Locate All** to locate all sample positions.
- 7.8.5 Double click on **Untitled** again, then click on the sequence name (i.e. : SEQ101010M1), on the data display area, type the sequence in Samplename column, dilution factor (if needed) in CorrFact column, check the box in front of Check column, and select an appropriate check table.
- 7.8.6 Once done with creating sequence, go to **Method** drop down menu and save all changes as **Save As**. There will be a Save a Method dialog box present, go to the save option to check on “Overwrite Method and bump revision number” box, and then click **Ok**.
- 7.8.7 Go to Sequence tab, click on List View Icon from tool bar, then click on Connect Autosampler to PC and Initialize Icon.
- 7.8.8 See table 8 for a typical run sequence.
- 7.9 Calibrate the instrument as outlined below. See table 3 for calibration standards concentrations. This calibration procedure is done a minimum of once every 24 hours. The calibration standards may be included in the auto sampler program or they may be run manually from the **Calibrate Instrument (graduated cylinder)** icon located on the Analyst tab. The instrument may be calibrated using a single point standard and a calibration blank or a multipoint calibration. If a multipoint calibration is used a minimum of three standards are required. All curves must be determined from a linear calibration prepared in the normal manner using the established analytical procedure for the instrument. Refer to instrument manual for further detail. Three exposures will be used with a percent relative standard deviation of less than 5 percent. The resulting correlation coefficient must be ≥ 0.995 . If the calibration curves do not meet these criteria, analysis must be terminated, the problem corrected, and instrument re-calibrated. Correlation coefficients, slopes, and y-intercepts for each wavelength are printed and included in each analytical data package.
- 7.10 Initial Calibration Verification Standard (ICV).
- After each calibration, a standard from a different source than the calibration standard shall be analyzed. For the ICV, all elements to be reported must be within 10 percent of the true value for 6010D. If the ICV is outside these criteria then the analysis must be terminated, problem corrected, and the instrument re-calibrated.
- 7.11 After analyzing the ICV, the ICB must be analyzed. The results of the ICB must be less than one half the reporting limit (LLOQ). The instrument blank may be failing the criteria due to contamination or instrument drift. Samples associated with the failing blank shall be evaluated as to the best corrective action for each particular sample. This may include reanalyzing the samples bracketed by the failing blank, qualifying the results with a “B” or “V” qualifier, or raising the reporting limit (LLOQ) for all samples to greater than two times the background concentration.

- 7.12 Before analyzing any real world samples the CRIA (also referred to as LLCCV) must be analyzed. The CRIA contains elements of interest at the reporting limit. The CRIA will be analyzed at the beginning and end of each analytical run. For all elements the results must be within 20 percent of the true value. Refer to scheduling sheets and/or project specific QAPP for further information regarding client specific reporting limits (CRIA Requirement). If the initial CRIA fails no samples associated with the failing CRIA can be reported, and the CRIA should be reanalyzed for the failing elements. If the closing CRIA fails the criteria, the samples associated with the CRIA shall be evaluated as to the best corrective action for each particular sample. This may include reanalyzing the samples associated with the CRIA, or qualifying the results in LIMS.
- 7.13 Before analyzing any real world samples, the Mixed element SIC solution must be analyzed. The mixed element SIC solution is used as an ongoing daily check of freedom from spectral interferences. The mixed element SIC contains the following elements: Aluminum 500 mg/l; Calcium 500 mg/l; Iron 500 mg/l; Magnesium 500 mg/l.

The daily mixed element SIC solution is analyzed daily after calibration. The concentration measured for any target analytes must be less than +/- the LLOQ. For spiked elements, the analyzed results must be within 20 percent of the true value for SIC check and within 10 percent for linear range check. If this criterion cannot be met then sample analysis may not proceed until the problem is corrected, or the LLOQ is raised to twice the concentration observed in the SIC solution. The only exceptions are those elements that have been demonstrated and documented as contaminants in the SIC solutions. Refer to section 17.0 of this SOP for Interfering Element Correction (IEC) procedure.

- 7.14 After the initial analytical quality control has been analyzed, the samples and the preparation batch matrix quality control shall be analyzed. Each sample analysis must be a minimum of 3 readings using at least a 5 second integration time. Between each sample, flush the nebulizer and the solution uptake system with a blank rinse solution for at least 60 seconds or for the required period of time to ensure that analyte memory effects are not occurring.
- 7.15 Analyze the continuing calibration verification solution and the continuing calibration blank after every tenth sample and at the end of the sample run. If the CCV solution is not within 10 percent of the true value for method 6010D, the CCV shall be reanalyzed to confirm the initial value. If the CCV is not within criteria after the reanalysis, no samples can be reported in the area bracketed by the failing CCV. Immediately following the analysis of the CCV the CCB shall be analyzed. The results of the CCB must be less than one half the reporting limit (LLOQ) for all elements. The instrument blank may be failing the criteria due to contamination or instrument drift. Samples associated with the failing blank shall be evaluated as to the best corrective action for each particular sample. This may include reanalyzing the samples bracketed by the failing blank, qualifying the results with a "B" or "V" qualifier, or raising the reporting limit (LLOQ) for all samples to greater than two times the background concentration.
- 7.16 One sample per preparation batch, or whenever matrix interferences are suspected for a batch of samples, a serial dilution (SDL) must be prepared. For the serial dilution, a 1:5 dilution must be made on the sample. The results of the 1:5 dilution shall agree within 20 percent of the true value as long as the analyte concentration is within the linear range of the instrument and sufficiently high (minimally, a factor of 25 times greater than the LLOQ). If the

results are outside these criteria then matrix interference should be suspected and the proper footnote entered into LIMS. A post digestion spike (PDS) must be performed if the SDL fails. The PDS must recover within ± 25 percent for method SW846-6010D. If the PDS is outside these limits then matrix interference must be suspected and the proper footnote entered into LIMS.

- 7.17 The upper limit of quantitation may exceed the highest concentration calibration point and can be defined as the “linear range”. Sample results above the linear range shall be diluted under the linear range and reanalyzed. Following calibration, the laboratory may choose to analyze a standard (or mixed standard solution) at a higher concentration than the high standard used in the calibration curve. The standard must recover within 10 percent of the true value, and if successful, establishes the linear range. The linear range standards must be analyzed in the same instrument run as the calibration they are associated with, but may be analyzed anywhere in the run. Samples following a sample with high concentrations of analyte (s) must be examined for possible carryover. Verification may be done by rinsing the lines with an acid solution and then reanalyzing the sample. A limit check table is built into the autosampler file so that samples exceeding the standardization range are flagged on the raw data.
- 7.18 After the instrument is optimized and all initial QC has been run, click on **Run Auto-Session** Icon to start the analytical run sequence.
- 7.18.1 If you need to add or delete samples once the run is started, follow the steps shown below.
- 7.18.2 Click on **Sequence** tab, then click on **List View** Icon at the tool bar. There is the sequence table shown on the display area.
- 7.18.3 Click on **Add Samples** Icon. This will pop up a dialog box, and then fill in number of samples that need to be added. Click **Ok**. By doing this, samples will be added to the end of the current sequence without a rack location.
- 7.18.4 On the Samplename column type in the sample I.D., correction factors, and check tables. **Click on Auto Locate All.**
- 7.18.5 The added samples will be analyzed at the end of the original sequence run order unless they are assigned a different run order.
- 7.18.6 Deleting Samples
- 7.18.7 Click on **Sequence** tab, and then click on **List View** Icon under the sequence display area.
- 7.18.8 Highlight all samples that need to be deleted and then click on the **Delete Samples** icon.
- 7.19 When the analysis is completed export the data to LIMS following the procedure outlined below.

- 7.19.1 Double click on **ePrint** Icon on desktop. There will be a **LEADTOOLS ePRINT** pop up box, click on **Finish Jobs** and **OK** boxes.
- 7.19.2 Double click the **PDF** Icon on the desktop; the PDF file will be present as Document_#. Right click on that file, select **rename** to change the filename to an assigned analytical run I.D. (i.e.: MA9000). This is the raw data file for MA9000.
- 7.19.3 Drop the raw data to the **LIMS Data Drop** icon located on the desktop.
- 7.19.4 By completing the above steps, the raw data (i.e.: MA9000) can be viewed and/or printed from the Raw Data Search function.
- 7.19.5 Go to **Analysis** tab, right click on sample header, and select export all samples. A pop up dialog box will come up, type in the analytical run I.D. (i.e.: SA101010M1) and click **Ok**. Go to **Lims Export** folder located on the desktop, right click on analytical run and change extension from .TXT to .ICP. Open the analytical file and make any necessary changes, such as deleting any samples that need to be re-run on dilution. **Save** the file. Drop the data file to the **LIMS Data Drop** icon located on the desktop. This will then send the export file to LIMS for review.
- 7.20 The data can be evaluated by running an automated data evaluation program, which will help to generate quality control summary pages. Each run must be evaluated as quickly as possible to make sure that all required quality control has been analyzed. With each data package include: cover sheet, copies of all prep sheets, autosampler run sequence, dilution sheets, and raw data. Label each folder with MA#, instrument run I.D., instrument used, and date.
- 7.21 At the end of the analysis day the ICP must be shutdown using the following sequence.
 - 7.21.1 Place the auto sampler tip in the rinse cup and rinse in a mixed solution of approximately 5 percent nitric acid and 5 percent hydrochloric acid for 10 minutes and then in DI water for 20 minutes.
 - 7.21.2 Turn off the plasma by clicking on the **Plasma** Icon and then by clicking **Plasma Off**.
 - 7.21.3 Close all iTeva programs/windows.
 - 7.21.4 Release the tension on the sample pump platens.
 - 7.21.5 Turn off recirculating chiller.

8.0 QUALITY CONTROL

This section outlines the QA/QC operations necessary to satisfy the analytical requirements for method SW846 6010D. Please refer to scheduling sheets and/or project specific QAPP for further information regarding client specific QC requirements. Check with the area supervisor or lab manager for any non-compliant quality control for further information.

**CONTROLLED COPY
DO NOT DUPLICATE**

8.1 Initial Calibration Verification Standard (ICV).

After each calibration, a standard from a different source than the calibration standard shall be analyzed. For the ICV, all elements to be reported must be within 10 percent of the true value for 6010D. If the ICV is outside these criteria then the analysis must be terminated, problem corrected, and the instrument re-calibrated.

8.2 Continuing Calibration Blank/Initial Calibration Blank.

Analyze the Initial calibration blank solution at the beginning of each run and the continuing calibration blank after every tenth sample and at the end of the sample run. The ICB/CCB must be less than one half the reporting limit (LLOQ) for each element. The instrument blank may be failing the criteria due to contamination or instrument drift. Samples associated with the failing blank shall be evaluated as to the best corrective action for each particular sample. This may include reanalyzing the samples bracketed by the failing blank, qualifying the results with a "B" or "V" qualifier, or raising the reporting limit (LLOQ) for all samples to greater than two times the background concentration.

8.3 Low Standard Check (CRIA or LLCCV).

Before analyzing any real world samples the CRIA (also referred to as LLCCV) must be analyzed. The CRIA contains elements of interest at the reporting limit. The CRIA will be analyzed at the beginning and end of each analytical run. For all elements the results must be within 20 percent of the true value. Refer to scheduling sheets and/or project specific QAPP for further information regarding client specific reporting limits (CRIA Requirement). If the initial CRIA fails no samples associated with the failing CRIA can be reported, and the CRIA should be reanalyzed for the failing elements. If the closing CRIA fails the criteria, the samples associated with the CRIA shall be evaluated as to the best corrective action for each particular sample. This may include reanalyzing the samples associated with the CRIA, or qualifying the results in LIMS.

8.4 ICSA (Mixed SIC Solution)

Before analyzing any real world samples, the Mixed element SIC solution must be analyzed. The mixed element SIC solution is used as an ongoing daily check of freedom from spectral interferences. The mixed element SIC contains the following elements: Aluminum 500 mg/l; Calcium 500 mg/l; Iron 500 mg/l; Magnesium 500 mg/l.

The daily mixed element SIC solution is analyzed daily after calibration. The concentration measured for any target analytes must be less than +/- the LLOQ. For spiked elements, the analyzed results must be within 20 percent of the true value for SIC check and within 10 percent for linear range check. If this criterion cannot be met then sample analysis may not proceed until the problem is corrected, or the LLOQ is raised to twice the concentration observed in the SIC solution. The only exceptions are those elements that have been demonstrated and documented as contaminants in the SIC solutions. Refer to section 17.0 of this SOP for Interfering Element Correction (IEC) procedure.

8.5 Continuing Calibration Verification.

Analyze the continuing calibration verification solution and the continuing calibration blank after every tenth sample and at the end of the sample run. If the CCV solution is not within 10 percent of the true value for method 6010D the CCV must be reanalyzed to confirm the initial value. If the CCV is not within criteria after reanalysis no samples can be reported in the area bracketed by the failing CCV.

8.6 Method Blank.

The laboratory must digest and analyze a method blank with each batch of samples. The method blank must contain elements at less than one half the reporting limit (LLOQ) for each element. The exception to this rule is when the samples to be reported contain greater than 10 times the method blank level. In addition, if all the samples are less than a client required limit and the method blank is also less than that limit, then the results can be reported as less than that limit. Samples associated with the contaminated blank shall be evaluated as to the best corrective action for each particular sample. This may include reanalyzing the samples, re-digesting and reanalyzing the samples, qualifying the results with a "B" or "V" qualifier, or raising the reporting limit (LLOQ) to greater than two times the background concentration. All samples associated with an out of compliance method blank shall be qualified and footnoted in LIMS as well as the case narrative.

8.7 Blank Spike Sample.

The laboratory must digest and analyze a spike blank sample with each batch of samples. Blank Spikes must be within 20 percent of the true value for method SW846-6010D. If the lab control is outside of the control limits for a reportable element, all samples must be re-digested and reanalyzed for that element. The exception is if the lab control recovery is high and the results of the samples to be reported are less than the reporting limit (LLOQ). In that case, the sample results may be reported with no flag. For solid standard reference materials (SRMs) ± 20 percent accuracy may not be achievable and the manufacturer's established acceptance criterion should be used for all soil SRMs.

8.8 Matrix Spike and Matrix Spike Duplicate Recovery.

The laboratory must digest and analyze a matrix spike and matrix spike duplicate with each batch of samples. The matrix spike recovery is calculated as shown below and must be within 20 percent of the true value for method SW846-6010D. If a matrix spike is out of control, then the results must be flagged with the appropriate footnote. If the matrix spike amount is less than one fourth of the sample amount, then the sample cannot be assessed against the control limits and must be footnoted to that effect.

Note: Both the matrix spike amount and the sample amount are calculated to the IDL for any given element. Any value less than the IDL is treated as zero.

$$\frac{(\text{Spiked Sample Result} - \text{Sample Result})}{\text{Amount Spiked}} \times 100 = \text{matrix spike recovery}$$

8.9 Matrix Duplicate/Matrix Spike Duplicate Relative Percent Difference.

The laboratory must digest a duplicate with each batch of samples. The relative percent difference (RPD) between the duplicate and the sample must be assessed and must be \leq 20 percent for sample results at or above the reporting limit (LLOQ). If the RPD is outside the 20 percent criteria the results must be qualified in LIMS. RPD's are also calculated in LIMS for sample results below the reporting limit (LLOQ). RPD's outside the 20 percent criteria are not considered failing and LIMS automatically footnotes these as "RPD acceptable due to low duplicate and sample concentrations."

Note: Both the duplicate amount and the sample amount are calculated to the IDL for any given element. Any value less than the IDL is treated as zero.

$$\frac{(|\text{Sample Result} - \text{Duplicate Result}|) \times 100}{(\text{Sample Result} + \text{Duplicate Result})/2} = \text{Duplicate RPD}$$

8.10 Serial Dilution Analysis and Post Digestion Spike.

One sample per preparation batch, or whenever matrix interferences are suspected for a batch of samples, a serial dilution (SDL) must be prepared. For the serial dilution, a 1:5 dilution must be made on the sample. The results of the 1:5 dilution shall agree within 20 percent of the true value as long as the analyte concentration is within the linear range of the instrument and sufficiently high (minimally, a factor of 25 times greater than the LLOQ). If the results are outside these criteria then matrix interference should be suspected and the proper footnote entered into LIMS. A post digestion spike (PDS) must be performed if the SDL fails. The PDS must recover within \pm 25 percent for method SW846-6010D. If the PDS is outside these limits then matrix interference must be suspected and the proper footnote entered into LIMS.

$$\frac{(\text{Sample Result} - \text{Serial Dil. Result}) \times 100}{\text{Sample Result}} = \text{Serial Dilution RPD}$$

8.11 Linear Calibration ranges.

The upper limit of quantitation may exceed the highest concentration calibration point and can be defined as the "linear range". Sample results above the linear range shall be diluted under the linear range and reanalyzed. Following calibration, the laboratory may choose to analyze a standard (or mixed standard solution) at a higher concentration than the high standard used in the calibration curve. The standard must recover within 10 percent of the true value, and if successful, establishes the linear range. The linear range standards must be analyzed in the same instrument run as the calibration they are associated with, but may be analyzed anywhere in the run. Samples following a sample with high concentrations of analyte (s) must be examined for possible carryover. Verification may be done by rinsing the lines with an acid solution and then reanalyzing the sample. A limit check table is built into the autosampler file so that samples exceeding the standardization range are flagged on the raw data.

8.12 Sample RSD

For samples containing levels of elements greater than five times the reporting limits (LLOQ), the relative standard deviation for the replicates should be less than 5%. If not, reanalyze the sample. If upon reanalysis, the RSD's are acceptable then report the data from the reanalysis. If RSD's are not acceptable upon reanalysis, then the results for that element should be footnoted that there are possible analytical problems and/or matrix interference indicated by a high RSD between replicates.

8.13 Interelement Spectral Interference Correction Validity

For the interelement spectral interference corrections to remain valid during sample analysis, the interferent concentration must not exceed its linear range. If the interferent concentration exceeds its linear range or its correction factor is big enough to affect the element of interest even at lower concentrations, sample dilution with reagent blank and reanalysis is required. In these circumstances, analyte dilution limits are raised by an amount equivalent to the dilution factor.

8.14 Internal Standard (Yttrium/Indium)

For any readings where the internal standard is outside of the range 60-125 percent of the internal standard level in the reference standard (Initial Calibration Blank), then the sample must be diluted until the internal standard is within range and all sample results must be footnoted in LIMS.

8.15 MSA (Method of Standard Additions)

SGS - Orlando uses the internal standard technique as an alternative to the MSA per SW846-6010D section 4.4.2. However, in certain circumstances MSA may be needed by some project specific requirements. SGS - Orlando may perform an MSA when sample matrix interference is confirmed through the post digestion spike process or may qualify the results in LIMS. SGS - Orlando will use a single addition method as described in SW846-7000B.

9.0 GLASSWARE CLEANING

All glassware must be washed with soap and tap water and then rinsed with 5 percent nitric acid. It must then be rinsed at least 3 times with DI water. Refer to SOP GN196, current revision for further information regarding glassware cleaning.

10.0 DOCUMENTATION REQUIREMENTS

Refer to the Laboratory Quality Assurance Manual for documentation requirements. All raw data is printed to .PDF format and archived to a backup server for long term storage.

11.0 SAFETY

The analyst must follow normal safety procedures as outlined in the SGS - Orlando Safety Manual which includes the use of safety glasses and lab coats. In addition, all acids are corrosive and must be handled with care. Flush spills with plenty of water. If acids contact any part of the body, flush with water and contact the supervisor. Follow proper safety precautions when working with gas cylinders.

12.0 CALCULATIONS

For water samples, the following calculations must be used. Refer to the QC section for the calculations to be used for the QC samples.

Original sample concentration of metal (ug/l) =

$$\frac{(\text{conc. in the digestate (ug/l)}) \times (\text{final digestate volume (ml)})}{(\text{initial sample volume (ml)})}$$

For soil samples, the following calculations must be used.

Concentration of the metal in the dry sample (mg/kg) =

$$\frac{(\text{conc. in the digestate (mg/l)}) \times (\text{final digestate volume (L)})}{(\text{sample wt. (kg)}) \times (\% \text{ solids}/100)}$$

13.0 INSTRUMENT MAINTENANCE

Recommended periodic maintenance includes the items outlined below. All maintenance must be recorded in the instrument maintenance log.

- 13.1 Change the pump tubing as needed.
- 13.2 Clean the filter on the recirculating pump approximately once a month and dust off the power supply vents as needed.
- 13.3 Clean or replace the nebulizer, torch assembly, and injector tube as needed.
- 13.4 Change the sampler tip as needed.
- 13.5 Clean the recirculating pump lines and internal sock filter every 3 months or as needed.
- 13.6 Clean the radial view quartz surface weekly or more often if needed.

14.0 POLLUTION PREVENTION AND WASTE MANAGEMENT

- 14.1 Pollution Prevention

Users of this method must perform all procedural steps in a manner that controls the creation and/or escape of wastes or hazardous materials to the environment. The amounts of standards, reagents and solvents must be limited to the amounts specified in this SOP. All safety practices designed to limit the escape of vapors, liquids or solids must be followed. All method users must be familiar with the waste management practices described in Section 14.2.

14.2 Waste Management

Individuals performing this method must follow established waste management procedures as described in the Sample and Laboratory Waste Disposal SOP SAM108, current revision. This document describes the proper disposal of all waste materials generated during the testing of samples.

15.0 GENERIC DEFINITIONS

- 15.1 Batch: A group of samples which are similar with respect to matrix and the testing procedures being employed and which are processed as a unit. A sample batch is limited to a maximum of 20 samples or 24 hours whichever comes first.
- 15.2 Blank Spike (BS): An analyte-free matrix spiked with a known amount of analyte(s), processed simultaneously with the samples through all the steps of the analytical procedure. Blank Spike Recoveries are used to document laboratory performance for a given method. This may also be called a Laboratory Control Sample (LCS).
- 15.3 Continuing Calibration Verification (CCV): A check standard used to verify instrument calibration throughout an analytical run. A CCV must be analyzed at the beginning of the analytical run, after every 10 samples, and at the end of the run.
- 15.4 Holding Time: The maximum times that samples may be held prior to preparation and/or analysis and still be considered valid.
- 15.5 Initial Calibration (ICAL): A series of standards used to establish the working range of a particular instrument and detector. The low point must be at a level equal to or below the reporting level.
- 15.6 Initial Calibration Verification (ICV): A standard from a source different than that used for the initial calibration. A different vendor must be used whenever possible. The ICV is used to verify the validity of an Initial Calibration. This may also be called a QC check standard.
- 15.7 Matrix Spike (MS): A sample aliquot spiked with a known amount of analyte(s), processed simultaneously with the samples through all the steps of the analytical procedure. The matrix spike recoveries are used to document the performance of a method in a given sample matrix.

- 15.8 Matrix Spike Duplicate (MSD): A replicate sample aliquot spiked with a known amount of analyte(s), processed simultaneously with the samples through all the steps of the analytical procedure. The matrix spike recoveries are used to document the precision and performance of a method in a given sample matrix.
- 15.9 Method Blank (MB): An analyte-free matrix to which all reagents are added in the same volumes or proportions as used in sample processing. The method blank is processed simultaneously with the samples through all the steps of the analytical procedure. The method blank is used to document contamination resulting from the analytical process.
- 15.10 Sample Duplicate (DUP): A replicate sample which is used to document the precision of a method in a given sample matrix.
- 15.11 Preservation: Refrigeration and/or reagents added at the time of sample collection (or later) to maintain the chemical integrity of the sample.

16.0 METHOD PERFORMANCE

Method performance is monitored through the routine analysis of negative and positive control samples. These control samples include method blanks (MB), blank spikes (BS), matrix spikes (MS), and matrix spike duplicates (MSD). The MB and BS are used to monitor overall method performance, while the MS and MSD are used to evaluate the method performance in a specific sample matrix.

Blank spike, matrix spike, and matrix spike duplicate samples are compared to method defined control limits. Statistical control limits are stored in the LIMS for QA purposes only. Additionally, blank spike accuracy is regularly evaluated for statistical trends that may be indicative of systematic analytical errors.

17.0 GENERATION OF INTERFERING ELEMENT CORRECTION FACTORS

- 17.1 It is recommended that all IEC's be verified and updated approximately every 6 months or whenever instrument conditions change significantly. It is also recommended that elements with frequent high concentrations or with large IEC's should be checked more frequently.
- 17.2 Calculate the IEC correction factors and enter them into the method (refer to Thermo 6500 instrument manual). Calculate the correction factor using the equation shown below. This correction factor must be added to the correction factor already in place in the method for a given element.

$$\text{IEC} = \frac{\text{Concentration Result of the element with the interference}}{\text{Concentration result of the interfering element}}$$

- 17.3 Verify the new correction factors by reanalyzing the ICSA/ICSAB solutions and/or the SIC solutions or by reloading and recalculating the previously stored results. If the reanalysis is not within QC limits, make additional changes to the IEC factors and then re-verify both the individual and combined solution values.

CONTROLLED COPY
DO NOT DUPLICATE

- 17.4 Save and update the method.
- 17.5 Interfering element correction factors are saved as raw data along with the run printouts on a daily basis so that the IEC's for a given run are traceable.

TABLE 1: REPORTING LIMIT BY ELEMENT

Analyte	Water Reporting Limit(LLOQ) (ug/L)	Soil Reporting Limit(LLOQ)(mg/kg)	TCLP Reporting Limit(LLOQ) (mg/L)/MCL
Tin	50	5	
Aluminum	200	20	
Antimony	5	1	
Arsenic	10	0.5	0.10 / 5.0
Barium	200	20	10 / 100
Beryllium	4	0.5	
Cadmium	5	0.4	0.05 / 1.0
Calcium	1000	500	
Chromium	10	1	0.10 / 5.0
Cobalt	50	5	
Copper	25	2.5	
Iron	300	10	
Lead	5	1	0.5 / 5.0
Magnesium	5000	500	
Manganese	15	1.5	
Nickel	40	4.0	
Potassium	5000	500	
Selenium	10	1	0.5 / 1.0
Silver	10	1	0.10 / 5.0
Sodium	5000	500	
Thallium	10	1	
Vanadium	50	5	
Zinc	20	2	
Molybdenum	50	2.5	
Strontium	10	0.5	
Titanium	10	0.5	

TABLE 2. THERMO 6500 ANALYSIS LINES

Element	Wavelength
Al	396.1
As	189.042
Ca	317.933
Fe	259.9
Mg	279.078
Mn	257.610
Pb	220.353
Se	196.026
Tl	190.864
V	292.402
Ag	328.068
Ba	455.4
Be	313.042
Cd	226.502
Co	228.616
Cr	267.716
Cu	324.753
K	766.491
Na	589.5
Ni	231.604
Sb	206.838
Zn	206.2
Mo	202.030
Sn	189.900
Sr	407.7
Ti	334.9

TABLE 3: LOW, MID AND HIGH STANDARD LEVELS
Single Point Calibration (blank and high standard) may be used

Element	Low ug/l	Mid ug/l	High ug/l
Al	10000	40000	80000
As	500	2000	4000
Ca	10000	40000	80000
Fe	10000	40000	80000
Mg	10000	40000	80000
Mn	500	2000	4000
Pb	500	2000	4000
Se	500	2000	4000
Tl	500	2000	4000
V	500	2000	4000
Ag	62.5	250	500
Ba	500	2000	4000
Be	500	2000	4000
Cd	500	2000	4000
Co	500	2000	4000
Cr	500	2000	4000
Cu	500	2000	4000
K	10000	40000	80000
Na	10000	40000	80000
Ni	500	2000	4000
Sb	500	2000	4000
Zn	500	2000	4000
Mo	500	2000	4000
Sn	500	2000	4000
Sr	500	2000	4000
Ti	500	2000	4000

TABLE 4: ICV STANDARD LEVELS

Element	Concentration ug/l
Al	40000
As	2000
Ca	40000
Fe	40000
Mg	40000
Mn	2000
Pb	2000
Se	2000
Tl	2000
V	2000
Ag	250
Ba	2000
Be	2000
Cd	2000
Co	2000
Cr	2000
Cu	2000
K	40000
Na	40000
Ni	2000
Sb	2000
Zn	2000
Mo	2000
Sn	2000
Sr	2000
Ti	2000

TABLE 5: CCV STANDARD LEVELS

Element	Concentration ug/l
Al	40000
As	2000
Ca	40000
Fe	40000
Mg	40000
Mn	2000
Pb	2000
Se	2000
Tl	2000
V	2000
Ag	250
Ba	2000
Be	2000
Cd	2000
Co	2000
Cr	2000
Cu	2000
K	40000
Na	40000
Ni	2000
Sb	2000
Zn	2000
Mo	2000
Sn	2000
Sr	2000
Ti	2000

TABLE 6: CRIA(LLCCV) STANDARD LEVELS

Element	CRIA ug/l
Al	200
As	10
Ca	1000
Fe	300
Mg	5000
Mn	15
Pb	5
Se	5
Tl	10
V	50
Ag	10
Ba	200
Be	5
Cd	5
Co	50
Cr	10
Cu	25
K	5000
Na	5000
Ni	40
Sb	5
Zn	20
Mo	50
Sn	50
Sr	10
Ti	10

TABLE 7: BLANK SPIKE, MATRIX SPIKE AND MATRIX SPIKE DUPLICATE LEVELS

Element	Concentration ug/l
Al	27000
As	2000
Ca	25000
Fe	26000
Mg	25000
Mn	500
Pb	500
Se	2000
Tl	2000
V	500
Ag	50
Ba	2000
Be	50
Cd	50
Co	500
Cr	200
Cu	250
K	25000
Na	25000
Ni	500
Sb	500
Zn	500
Mo	500
Sn	500
Sr	500
Ti	500

TABLE 8: TYPICAL RUN SEQUENCE

BLANK
LOW
MID
HIGH
HIGH STD
ICV
ICB
CRIA
ICSA
ICSAB
CCV
CCB
MB
SB
SAMPLE1
DUPLICATE
SERIAL DILUTION
MATRIX SPIKE
MATRIX SPIKE DUPLICATE
POST DIGESTION SPIKE
SAMPLE2
SAMPLE3
CCV
CCB
SAMPLE4
SAMPLE5
SAMPLE6
SAMPLE7
SAMPLE8
SAMPLE9
SAMPLE10
SAMPLE11
SAMPLE12
SAMPLE13
CRIA CLOSING
ICSA CLOSING
ICSAB CLOSING
CCV
CCB

TABLE 9: ICSA (Mixed SIC) SOLUTION LEVELS

Element	Concentration mg/l
Al	500
As	0
Ca	500
Fe	500
Mg	500
Mn	0
Pb	0
Se	0
Tl	0
V	0
Ag	0
Ba	0
Be	0
Cd	0
Co	0
Cr	0
Cu	0
K	0
Na	0
Ni	0
Sb	0
Zn	0
Mo	0
Sn	0
Sr	0
Ti	0

TABLE 10: SINGLE ELEMENT INTERFERENCE CHECK SOLUTION (SIC) LEVELS

Element	Concentration mg/l
Al	500
As	0
Ca	500
Fe	500
Mg	500
Mn	4
Pb	0
Se	4
Tl	0
V	4
Ag	0
Ba	4
Be	0
Cd	0
Co	0
Cr	0
Cu	4
K	0
Na	1000
Ni	4
Sb	0
Zn	4
Mo	4
Sn	4
Si	50
Sr	0
Ti	0

REVISION HISTORY

Revision Date	Revision Number	Affected Section(s)	Revision Description
12/2020	05	“Revised Sections”	Added Revision History and removed Revised Sections.



DETERMINATION OF INORGANIC ANIONS BY ION CHROMATOGRAPHY

Prepared by: Jonathan P. Miller Date: 10/08/2019

Approved by: Svetlana Izosimova Date: 10/10/2019

Annual Review

Reviewed by: _____ Date: _____

Reviewed by: _____ Date: _____

Reviewed by: _____ Date: _____

Document Control

Issued to: QA Department Date: 10/10/2019

Issued to: General Chemistry Department Date: * 10/10/2019

Issued to: _____ Date: _____

Issued to: _____ Date: _____

Issued to: _____ Date: _____

Issued to: _____ Date: _____

Effective 7 days after "*" date

**CONTROLLED COPY
DO NOT DUPLICATE**

TITLE: DETERMINATION OF INORGANIC ANIONS BY ION CHROMATOGRAPHY

REFERENCES: EPA 300.0, Revision 2.1, 1993; SW846 9056A;
40CFR, part 136, App. B, Rev. 2, Dec. 2016 – MDL
procedure

REVISED SECTIONS: New Procedure.

1.0 SCOPE AND APPLICATION

- 1.1 This method is for the measurement of anions such as bromide, chloride, fluoride, nitrate, nitrite, phosphate and sulfate by ion chromatography. The method is applicable to potable and non-potable water, solids after extractions, and neutral leachates.

2.0 SUMMARY OF METHOD

- 2.1 This method addresses the sequential determination of the anions: fluoride, chloride, nitrite-N, bromide, nitrate-N, phosphate-P, and sulfate found in aqueous and solid samples. A small volume of aqueous sample is injected into an ion chromatograph to flush and fill a constant-volume sample loop. The sample is then injected into a flowing stream of carbonate-bicarbonate eluent. The sample is pumped through two different ion exchange columns, then a conductivity suppressor device, and into a conductivity detector. The two ion exchange columns, a precolumn or guard column and a separator column, are packed with an anion exchange resin. Ions are separated into discrete bands based on their affinity for the exchange sites of the resin. The suppressor is an ion exchange-based device that reduces the background conductivity of the eluent to a low or negligible level and simultaneously converts the anions in the sample to their more conductive acid forms. The separated anions in their acid forms are measured using an electrical conductivity cell. Anion identification is based on the comparison of analyte signal peak retention times relative to those of known standards. Quantitation is accomplished by measuring the peak area and comparing it to a calibration curve generated from known standards.
- 2.2 Detection limits vary with the instrument conditions and calibration levels used.

REPORTING LIMIT AND METHOD DETECTION LIMIT

- 3.1 Reporting Limit. The normal reporting limit for this method is normally established at or above the lowest non-zero concentration standard in the calibration curve. Detected concentrations below this concentration are not reported unless MDL reporting is being done. Reporting limits were set as follows:

**CONTROLLED COPY
DO NOT DUPLICATE**

<u>ANALYTE</u>	<u>REPORTING LIMIT</u>
Fluoride	0.20 mg/L
Chloride	2.00 mg/L
Nitrite	0.10 mg/L
Bromide	0.50 mg/L
Nitrate	0.10 mg/L
Phosphate	0.10 mg/L
Sulphate	2.00 mg/L

- 3.2 Method Detection Limit. Experimentally determine MDLs using the procedure specified in 40 CFR, Part 136, Appendix B, Rev. 2, 2016. This value represents the lowest reportable concentration of an individual compound that meets the method qualitative identification criteria. Refer to sec. 14.1 of current document and SOP QA020, current revision, for further details.

4.0 DEFINITIONS

- 4.1 Batch: A group of samples which are similar with respect to matrix and the testing procedures being employed and which are processed as a unit. A sample batch is limited to a maximum of 20 samples or samples loaded on an instrument within the same 12-hour shift, whichever comes first.
- 4.2 Blank Spike (BS): An analyte-free matrix spiked with a known amount of analyte(s), processed simultaneously with the samples through all the steps of the analytical procedure. Blank Spike Recoveries are used to document laboratory performance for a given method. This may also be called a Laboratory Control Sample (LCS).
- 4.3 Continuing Calibration Verification (CCV): A check standard used to verify instrument calibration throughout an analytical run. CCV must be analyzed at the beginning of the analytical run, after every 10 samples, and at the end of the run.
- 4.4 Holding Time: The maximum times that samples may be held prior to preparation and/or analysis and still be considered valid.
- 4.5 Initial Calibration (ICAL): A series of standards used to establish the working range of a particular instrument and detector. The low point should be at a level equal to or below the reporting level.
- 4.6 Initial Calibration Verification (ICV): A standard from a source different than that used for the initial calibration. A different vendor should be used whenever possible. The ICV is used to verify the validity of an Initial Calibration. This may also be called a QC check standard.
- 4.7 Matrix Spike (MS): A sample aliquot spiked with a known amount of analyte(s), processed simultaneously with the samples through all the steps of the analytical procedure. The matrix spike recoveries are used to document the bias of a method in a given sample matrix.

- 4.8 Matrix Spike Duplicate (MSD): A replicate sample aliquot spiked with a known amount of analyte(s), processed simultaneously with the samples through all the steps of the analytical procedure. The matrix spike duplicate recoveries are used to document the precision and bias of a method in a given sample matrix.
- 4.9 Method Blank (MB): An analyte-free matrix to which all reagents are added in the same volumes or proportions as used in sample processing. The method blank is processed simultaneously with the samples through all the steps of the analytical procedure. The method blank is used to document contamination resulting from the analytical process.
- 4.10 Method Detection Limits (MDLs) MDL is defined as the minimum concentration of a substance that can be measured and reported with 99% confidence that the analyte concentration is greater than zero and is determined from analysis of a sample in a given matrix containing the analyte. This definition is qualitative in nature and does not evaluate an acceptable quantitative limit for method performance. MDLs should be determined semiannually for every matrix in this method. Refer to SOP QA020, current revision.
- 4.11 Reagent Blank: The reagent blank is a blank that has the same matrix as the samples, i.e., all added reagents, but did not go through sample preparation procedures. The reagent blank is an indicator for contamination introduced during the analytical procedure. For methods requiring no preparation step, the reagent blank is equivalent to the method blank.
- 4.12 Reagent Grade: Analytical reagent (AR) grade, ACS reagent grade, and reagent grade are synonymous terms for reagents, which conform to the current specifications of the Committee on Analytical Reagents of the American Chemical Society.
- 4.13 Reagent Water: Water that has been generated by any method, which would achieve the performance specifications for ASTM Type II water.
- 4.14 Reference Material: A material containing known quantities of target analytes in solution or in a homogeneous matrix. It is used to document the bias of the analytical process.
- 4.15 Sample Duplicate (DUP): A replicate sample which is used to document the precision of a method in a given sample matrix.
- 4.16 Preservation: Refrigeration and/or reagents added at the time of sample collection (or later) to maintain the chemical integrity of the sample.

5.0 HEALTH & SAFETY

- 5.1 The analyst should follow normal safety procedures as outlined in the SGS Health and Safety Program which includes the use of safety glasses and lab coats. In addition, all acids are corrosive and should be handled with care. Flush spills with plenty of water. If acids contact any part of the body, flush with water and contact the supervisor.

CONTROLLED COPY
DO NOT DUPLICATE

- 5.2 The toxicity or carcinogenicity of each reagent used in this method has not been precisely determined; however, each chemical should be treated as a potential health hazard. Exposure to these reagents should be reduced to the lowest possible level. The laboratory is responsible for maintaining a current awareness file of OSHA regulations regarding the safe handling of the chemicals specified in this method. A reference file of data handling sheets should be made available to all personnel involved in these analyses.

6.0 COLLECTION, PRESERVATION, AND HOLDING TIME

- 6.1 Samples must be cooled to $<6^{\circ}\text{C}$ at the time of collection.
- 6.2 Bromide, Chloride, Fluoride, and Sulfate must all be analyzed within 28 days. Nitrite, Nitrate and Phosphate must be analyzed within 48 hours for aqueous samples. For solids, the same hold time applies, after the samples are prepared (see section 10.1.)
- 6.2.1 Samples being analyzed for nitrite/nitrate combined can be preserved with sulfuric acid to a $\text{pH} < 2$ and have a holding time of 28 days. Preserved samples can be analyzed at 5x dilution provided that the elevated Reporting Limits are satisfactory for the client needs.
- 6.2.2 Nitrite/nitrate combined samples may be analyzed using an unpreserved sample if the 48 hour holding time for the separated analytes is met.

Note: State of West Virginia requires 48 hours from collection to completion for NO_2/NO_3 , regardless of matrix.

7.0 APPARATUS AND MATERIALS

- 7.1 Ion Chromatograph with a guard column, an analytical column, a suppressor column, and a conductivity detector. This SOP is written for the use with the Metrohm 930 Compact IC Flex and associated 858 Autosampler. System is equipped with an Ultrafiltration cell that filters all samples to $0.20\ \mu\text{m}$. The eluent used is dependent upon column selection and should be based off the supporting literature. Any augmentation/changes made to the suggested eluent should be properly recorded in the solution prep log, and Section 8 of this document updated accordingly. The columns used are listed below. Alternate columns may be used if all method requirements can be met.

Maintenance and troubleshooting procedures are described in detail in operation manual. Most basic procedures include checking connections for leaks, cleaning and/or replacing tubing, monitoring and recording the pressure. See Sec.12.0.

- 7.1.1 Suppressors, Primary suppression is accomplished by use of the Metrohm MSM Chemical Suppression Module, and CO_2 suppression is accomplished by use of the Metrohm MCS module.
- 7.1.2 Guard Column, Metrosep A Supp 4/5 Guard (or equivalent). Metrohm PN 61006500.
- 7.1.3 Analytical Column, Metrosep A Supp 5-150 (or equivalent). Metrohm PN 61006520

**CONTROLLED COPY
DO NOT DUPLICATE**

- 7.1.4 Data System, MagIC Net version 3.2 Build 123 Data system's revisions will be updated during annual SOP revisions. Data system changes prior to the date of revision are to be recorded in Maintenance log.
- 7.2 Top loading balance, capable of weighing to 0.01g. Calibrated and serviced annually by outside vendor and verified daily with Class 1 weights.
- 7.3 Analytical balance capable of accurately weighing to the nearest 0.0001 g.
- 7.4 Centrifuge Centra CL2, or equivalent
- 7.5 Class 1 weights
- 7.6 Volumetric glassware, class A. Alternately, 50mL digestion cups may be used to prepare solutions in smaller volumes provided said cups are certified Class A equivalent.
- 7.7 IC vials and caps (Metrohm PN SNG-43200)
- 7.8 Volumetric pipettes, class A or autopipettors. Note: If autopipettors are used, make sure that the calibration is checked before use as specified in the autopipettor SOP QA006, current revision.
- 7.9 Nylon 0.45µm membrane filters or equivalent.
- 7.10 Disposable syringes, for sample filtering of soil extracts and extremely solid-laden aqueous samples. Pre-filtration is not necessary for most samples. The IC system has inline filtration of all samples to 0.20 µm.
- 7.11 Ultrafiltration membrane-Nylon 0.20 µm/47mm. (Metrohm PN SNG-IC14020).
- 7.12 Conductivity meter to pre-determine dilutions for possible interferences. This screening step may be omitted if sample history is known, and or sample matrix appears to be relatively clean. The system will auto-dilute any over range samples, so pre-screening is not critical unless samples are suspected to be of an extreme nature (ie: brines, plating baths, etc.). If needed, samples can be pre-diluted prior to going on the instrument provided that manual dilution is recorded properly in the software to ensure correct sample concentration is reported.

8.0 REAGENTS AND STANDARDS

All chemicals listed below are reagent grade unless otherwise specified. Deionized water must be used whenever water is required.

- 8.1 Individual Parent Stock Solutions: It is suggested that 1000mg/L individual anion standards be purchased commercially for Fluoride, Chloride, Nitrite (as N), Bromide, Nitrate (as N), Phosphate (as P), and Sulphate. If needed, prepared stocks can be made using the appropriate amount of a respective ACS grade salt. Reference the available

**CONTROLLED COPY
DO NOT DUPLICATE**

methods/literature for proper amounts. **Note that two sources are required for each anion standard. 1st Source is used for calibration, a 2nd Source for verification.**

- 8.2 Combined Anion Working Stock Calibration Solution: 1st Source. A single Combined Anion Working Calibration Stock solution is used for the calibration of the instrument. The Combined Anion Working Stock is the same concentration as Standard 10 for the calibration curve. This standard can be made of commercially available individual parent anion standards, or solutions prepared from salts (Section 8.1). Prepare fresh for each calibration. **Appropriate expiration dates must be applied to all standards and reagents. Concentrated solutions greater than 100mg/L may be kept for 1 month, while working solutions (ie: CCV and BS) should be prepared fresh daily for solutions containing NO₂, NO₃ and PO₄. Prepare as indicated below.**

To prepare 50mL of Combined Anion Working Stock Calibration

	Final Concentration	Vol. of 1000mg/L Parent Stock for 50mL	Concentration of Parent Stock
F	20 mg/L	1.00 mL	1000 mg/L
Cl	100 mg/L	5.00 mL	1000 mg/L
NO₂-N	15 mg/L	0.75 mL	1000 mg/L
Br	20 mg/L	1.00 mL	1000 mg/L
NO₃-N	15 mg/L	0.75 mL	1000 mg/L
PO₄-P	15 mg/L	0.75 mL	1000 mg/L
SO₄	100 mg/L	5.00 mL	1000 mg/L

- 8.2.1 The Combined Anion Working Stock Calibration Standard (8.2) is loaded directly onto the instrument for calibration. Per the selected method, the instrument software will prepare the calibration curve by diluting the Working Stock solution (up to 100x). The suggested final concentrations and their corresponding dilutions for the method are listed in the table below, but alternate ranges can be used to meet various reporting requirements. **Standard 100 is the Calibration Blank and consists of DI Water.**

Standard ID	STD 100	STD 1	STD 2	STD 3	STD 4	STD 5	STD 6	STD 7	STD 8	STD 9	STD 10
Dilution Factor	1	100	50	40	20	10	5	2.5	2	1.25	1
Concentration mg/L											
F	0	0.2	0.4	0.5	1	2	4	8	10	16	20
Cl	0	1	2	2.5	5	10	20	40	50	80	100
NO2	0	0.15	0.3	0.375	0.75	1.5	3	6	7.5	12	15
Br	0	0.2	0.4	0.5	1	2	4	8	10	16	20
NO3	0	0.15	0.3	0.375	0.75	1.5	3	6	7.5	12	15
PO4	0	0.15	0.3	0.375	0.75	1.5	3	6	7.5	12	15
SO4	0	1	2	2.5	5	10	20	40	50	80	100

**Note that all calibration points may not be used for the final working calibration. The number of points used are based on the curve fit used and the corresponding method requirements. It is suggested that a minimum of six points with a quadratic curve fit and 1/x weighting be applied when possible. Use of this calibration model is dependent upon regulatory guidance from the state where the sample is collected. Note that WV and Pennsylvania do not allow for Quadratic curve fit as of this revision. All other states allow for this curve fit per Volume 77, No. 97 of the Federal Register pg. 29811 Section 136.6 b.4.x.A which specifically calls out EPA 300.0 as a method in which the curve fit is one of a non-linear response.

- 8.3 Continuing Calibration Verification (CCV) 1st Source. Continuing Calibration Verification is prepared from the Individual Parent Stock solutions (8.1). Suggested concentrations are as follows:

CCV	mg/L
F	2.50
Cl	50.0
NO2-N	2.50
Br	10.00
NO3-N	2.50
PO4-P	2.50
SO4	50.0

- 8.4 Initial Calibration Verification (ICV) 2nd Source. The ICV can be made at the same concentrations that the CCV is but MUST be from a different source than the CCV. It must be within the range of the curve. Alternatively, it can be purchased from an outside supplier.
- 8.5 Stock Eluent (100x Concentration-320mM Na₂CO₃, 100mM NaHCO₃): In a 1000mL flask, add approximately 300mL of DI H₂O. Using oven dried reagent, dried at 105°C, (temperature should not exceed 110 °C) weigh 33.916g of Na₂CO₃ and 8.401g of NaHCO₃, and add to

**CONTROLLED COPY
 DO NOT DUPLICATE**

flask. Bring this solution to volume. Store tightly closed to eliminate CO₂ adsorption. Stable for at least 1 month at room temperature, and up to 6 months if refrigerated.

- 8.6 Working Eluent Solution (3.2mM Na₂CO₃, 1.0mM NaHCO₃): Dilute Stock Eluent –Sec. 8.5 using 20mL of stock in a 2000mL flask and bring up to volume. This solution is stable for several weeks if proper care is given to avoid CO₂ adsorption.
- 8.7 Suppressor Regenerant Solution-500mM H₂SO₄: Pipet 14 mL of concentrated H₂SO₄ into 100 mL DI and dilute to final volume of 500mL with DI. Solution can be augmented with up to 100mM Oxalic Acid (12.607g/L Oxalic Acid Dihydrate) if analyzing samples suspected to be high in heavy metals.

9.0 INTERFERENCES

- 9.1 Interferences can be caused by substances with retention times that are similar to and overlap those of the anion of interest. This interference is especially important at low concentrations.
- 9.2 The acetate anion elutes early during the chromatographic run and can cause elution times of other anions to vary when large amounts of acetate are present. High levels of acetate also can cause interference with the fluoride peak. Therefore, this method is not recommended for leachates containing acetic acid.

Large amounts of an anion can interfere with the peak resolution of an adjacent anion. High concentrations of an anion can also cause the peak to be misidentified on the chromatograph due to the large width of the peak. Sample dilution and fortification can be used to correct most interference problems connected with peak resolution.

10.0 SAMPLE PREPARATION PROCEDURE

- 10.1 For soil samples, follow the preparation outlined below.
 - 10.1.1 Mix the sample well and remove any artifacts as discussed in SOP QA034, current revision. Weigh approximately 5g of sample and add 50mL of DI water. Mix or shake the resulting slurry for 10 minutes. Record the weight to the nearest 0.01g on preparation log.
 - 10.1.2 For matrix spikes, make sure to spike the aliquot of the sample directly and then add the volume of DI water needed to make the volume of liquid being added to the soil sample equal to 50 mL including the volume of the spike solutions. In most cases this will be 49.75 mL of DI.
 - 10.1.3 Prepare blank QC (Method Blank and Blank Spike) using a clean solid matrix, using approximately 5g aliquot and 50mL of DI water. Record the weight to nearest 0.01g.
 - 10.1.4 Check with the lab supervisor if there is insufficient sample to use a 5g aliquot. Smaller aliquots may be used if a homogeneous portion of the sample can be obtained. The sample must always be extracted with 10 times the sample weight of DI water.

CONTROLLED COPY
DO NOT DUPLICATE

10.1.5 Centrifuge samples and QC for 10 minutes at 2000 RPM. Decant supernatant of centrifugation procedure directly into sample tube if clear of suspended material. Samples still containing suspended matter or turbidity may be further filtered using 0.45µm syringe filters

For aqueous samples containing large amounts of particulate matter, or extreme turbidity, pre-filter samples through 0.45µm filters pouring into sample vials.. Matrix spikes must be spiked before filtration. Pre-filter method blanks and blank spikes to act as QC check of the filters, only if there are samples in the batch that have been filtered. Record which samples have been filtered and the lot number of the filters in the run log. An unfiltered Method Blank and unfiltered Blank Spike are required for every batch of samples.

11.0 ION CHROMATOGRAPHY ANALYSIS PROCEDURE

11.1 A general knowledge of MagIC Net software is need for effective operation of the instrument. This document assumes the operator has had training on the software and has a general understanding of instrumental analysis and concepts as they relate to ion chromatography (separation theory, linear regression, calibration principles, etc.)

11.2 Instrument Calibration

11.2.1 It is recommended that a new calibration be run a minimum of once per month. (It is required that a calibration be run once per quarter.) Calibrations standards may be varied from the one stated in this SOP depending on the levels of each anion that are to be reported. A minimum of 5 standards and a blank are required and a low standard must be at or below the reporting limit for each anion. A correlation coefficient of 0.995 or greater is required. If this correlation coefficient is not met, than the instrument must be recalibrated. Force to Origin (aka Force to Zero) is not permitted.

11.2.1.1 Using weighed regression 1/concentration is also acceptable. Same correlation coefficient of 0.995 or better is required for this calibration model. *For greater details refer to SOP QA042, current revision. (see also section 8.2.1 for additional information regarding acceptable calibration models)*

11.2.2 The IC is calibrated using external standard quantitation.

11.2.3 Establish ion chromatographic operating parameters per instrument manufacturers suggestion.

11.2.4 Establish the linear calibration range semi-annually. This is done by examining a calibration curve made with standards below and above the expected range. Determine at what concentrations the calibration is no longer linear.

11.2.5 Load the calibration standards via the autosampler. All calibration standards must be scheduled as sample type "**Standard**".

- 11.2.6 The results are used to prepare a calibration curve for each analyte.
- 11.2.7 Immediately following calibration, a low-level standard at the reporting limit must be analyzed. This low check must have the levels in standard 1 or at the reporting limit for the calibration outlined in this SOP and recoveries must be in the range of 50–150%. On a daily basis, it is recommended that a mid-level 2nd Source check standard (ICV) be analyzed prior to analysis of client samples. Recoveries must be within the range of 90-110%. (At a minimum, this check (ICV) must be analyzed immediately following each new calibration.) Continuing calibration checks (CCV) and continuing calibration blanks (CCB) must be ran every 10 samples as well to provide bracketing QC for all reportable samples. The continuing calibration checks must have recoveries in the range of 90-110%. Refer to the quality control section of this SOP for more detail on these quality control samples.
- 11.2.8 After the run is completed, review all of the chromatograms and check for overlapping peaks, dilutions, etc.
- 11.2.9 If one or more calibration levels are responsible for the calibration curve *not* being linear, the offending level can be dropped if, and only if, the offender is the highest level or lowest level of calibration.
- 11.2.10 If linearity still cannot be achieved, new standards must be prepared and/or instrument operation must be examined.
- 11.2.11 Verify the working calibration curve on each working day by running a CCV standard before any samples. The calibration must also be verified whenever the eluent strength is changed
- 11.2.12 If the retention time of any anion in the ICV or CCV check standards has shifted more than 10% from the original calibration curve retention time, then no results can be reported for that anion. The column should be reconditioned, if necessary, and the instrument recalibrated before any more samples are reported for that anion. Affected samples are reanalyzed after the problem has been corrected.
- 11.2.13 If a sample peak has shifted significantly from the original retention time (and the ICV and CCV check standards are within the 10% retention time window), then verify the reported result using a spike on that sample. Do not report results from peaks where the retention time has shifted more than 10 percent unless the peak can be verified using a known spike.
- 11.2.14 For large or overlapping peaks, make dilutions. If at all possible, make dilutions and reruns on the same run as the original sample.
- 11.2.15 Refer to section 14.7 for information on how to determine the appropriate retention time window.

11.3 Samples may be scheduled using the Determination Series found in the Workplace of the

**CONTROLLED COPY
DO NOT DUPLICATE**

software. Special attention need be given to ensure proper sample table setup when using advanced techniques such as Metrohm in-Vial Dilution Technique (MIVDT). **With advanced methods, the various information fields found in the Sample Table drive the logic of the method. It is very important to adhere to the guidance indicated in Appendix A: Sample Table Control Guideline to ensure proper scheduling.**

11.4 Review all data and update the appropriate tests in the LIMS system. A write-up including a run log, a calibration summary, batch quality control summary, and copies of all chromatograms should be turned into the area supervisor for each batch.

11.4.1 If edits are needed in the calibration after the data has been calculated, the run can be reprocessed using the batch function in the software. Refer to the instrument manuals or on-screen help for addition information.

12.0 INSTRUMENT MAINTENANCE

12.1 If system pressure increases from nominal values, the suppressor may need to be cleaned. Refer to Metrohm document number 8.110.8010 for cleaning instructions.

12.2 The four in-line sample filters on the 930 Compact IC Flex and the one in-line filter on the 858 Professional Sample Processor need to be changed on a regular basis (Quarterly) or as needed.

12.3 Guard and analytical columns should be changed as dictated by instrument response and standard recoveries. An increase in nominal system pressure can be an indication of fouling from either the columns or the inline filters.

12.4 The instrument must be recalibrated whenever new guard or analytical columns are installed.

12.5 Samples high in metal concentration (especially aluminum and iron) can coat the MSM resin and affect both the baseline and the peak response.

12.6 A series of three 200 mM oxalic acid "samples", followed by three blanks, may be ran at the end of a batch to cleanse the entire system of metal contamination. If problems persist with suppressor, refer to section 12.1.

12.7 Augmenting the suppressor regenerant solution (8.7) to a total concentration of 1000 mM H₂SO₄ and 1-200 mM oxalic acid will prevent MSM contamination when running samples high in metal concentration.

12.8 **All maintenance performed on the instrument must be recorded in the maintenance log.**

13.0 METHOD PERFORMANCE

Method performance (accuracy and precision) is monitored through the routine analysis of negative and positive control samples. These control samples include method blanks (MB), blank spikes (BS), matrix spikes (MS), and matrix spike duplicates (MSD). The MB and BS are used to monitor overall method performance, while the MS and MSD are used to evaluate the method performance in a specific sample matrix.

Blank spike, matrix spike, and matrix spike duplicate samples are compared to method defined control limits. Control limits are stored in the LIMS. Additionally, blank spike accuracy is regularly evaluated for statistical trends that may be indicative of systematic analytical errors.

Filtered method blanks and blank spikes to act as QC check of the filters. Unfiltered method blanks and blank spikes are used to monitor overall method performance.

14.0 QC REQUIREMENTS

14.1 A method detection limit study must be done when new operator begins work, or whenever there is a significant change in the background or instrument response. The MDL study is done following the procedure outlined in 40 CFR, Part 136, Appendix B, Rev. 2, 2016 (see also SGS - Orlando SOP QA020, current revision). If instrument conditions (columns, etc.) are modified, then a new MDL must be done.

14.2 A method blank and a spike blank are required to be run with every batch of 20 samples. Additionally, a matrix spike and a matrix duplicate are required for every 10 samples. In some cases a matrix spike duplicate may be required in place of a duplicate.

14.2.1 The method blank must contain $< \frac{1}{2}$ RL of each anion that is reported and this sample must be run with each set of samples in a batch. If the blank contains more than the reporting level, then all samples must be reanalyzed. If no sample volume remains to be reanalyzed, then the data must be flagged. (The exception is if the sample results are less than the reporting limit.)

Note: West Virginia state specific requirement for method blank must contain analyte at $< \text{MDL}$

14.2.1.1 Although the method states that values greater than the MDL should be suspect, this is not appropriate for the concentration levels being applied for this analysis. MDL's are generally up to 10 times lower than reporting limits for all analytes and values over the MDL do not impact data usability.

14.2.2 The recovery of the spike blank must be within the limits of 90-110% recovery for each anion that is reported and this sample must be run with each set of samples in a batch. If the recoveries are outside of this range, then all associated samples must be reanalyzed. If no sample volume remains to be reanalyzed, then the data must be flagged.

- 14.2.3 The matrix spike is spiked with all anions of interest. Method limits of 90 -110 % recovery must be applied. Control limits must be generated from laboratory data to support method limits. If the recoveries are outside of this range, and all other method quality control is within limits, then matrix interference should be suspected.
- 14.2.4 For matrix duplicates control limits of 10% RPD must be applied for all sample values within the calibration range (up to 10 times the reporting limit). If the RPD values are outside of this range, and all other method quality control is within limits, then sample non-homogeneity should be suspected.
- 14.3 An external source standard (ICV) must be analyzed after every new calibration and its recovery must be within 10% of the true value. If the ICV is not within $\pm 10\%$, a second ICV should be prepared and analyzed. If the ICV is still outside of the limits, sample analysis must be discontinued and the cause determined (preparation of ICV from third source, instrument recalibration, etc)
- 14.4 It is recommended that a new calibration be run a minimum of once per month. (It is required that a calibration be run once per quarter.) Calibrations standards may be varied from the one stated in this SOP depending on the levels of each anion that are to be reported. A minimum of 5 standards and a blank are required and a low standard must be at or below the reporting limit for each anion. A correlation coefficient of 0.995 is required.
- 14.4.1 A new calibration is required when standard retention times shift by more than 10% from the original calibration.
- 14.5 A low check at the reporting limit (CCV2) for each anion must be run after each calibration. Acceptance criteria is 50–150%.
- 14.6 Continuing Calibration Verification (CCV) Checks at or near the mid-level of the curve must be run at the beginning and the end of the run and after every 10 samples throughout the run. Every CCV must be followed by a continuing calibration blank (CCB). The CCV must have results within 90-110% of the true value. If the CCV results are outside of the acceptance criteria range, analyst must demonstrate acceptable performance with two CCVs analyzed immediately (started within 1 hour), with no samples between failing CCV and the two additional CCVs. The results for the CCB must be $< 1/2$ RL for an analyte. If they are not, then all bracketed samples for that analyte must be reanalyzed.
- 14.7 Retention time windows must be established whenever a new column/guard column is installed in an instrument or whenever a major change has been made to an instrument. Retention time shift is checked weekly with a CCV to ensure it does not exceed 10%, and the data is stored on LAN in GenChem directory.

Retention time windows are established by injecting standard mix three times over the course of 24 hours and calculating the standard deviation of the retention times of each analyte. Plus or minus three times the standard deviation of the retention times is defined as the retention time window of that compound.

Peak identification is based on the retention time of an analyte in the standard (initial or continuing) being used as the mid-point of the retention time window. The retention time windows should be used as a guide for identifying compounds; however, the experience of

CONTROLLED COPY
DO NOT DUPLICATE

the analyst should weigh heavily in the interpretation of the chromatograms. The analyst should monitor the retention times of known standard peaks throughout an instrument run as an indication of instrument performance.

Because calculated retention time windows are generally very tight (less than ± 0.10 minutes), the retention time windows for the data processing method are generally set wider than the calculated window. This is done to ensure that the software does not miss any potential "hits". The analyst will then review these "hits" and determine if the retention times are close enough to the retention time of the target analyte to positively identify the peak or to require confirmation.

- 14.8 The Linear Calibration Range (LCR) is the concentration range the instrument response is linear and must be initially determined and verified every 6 months or whenever a significant change in the instrument is observed or expected. Initially, enough standards must be used to insure the curve is linear. The linearity verification must use at a minimum, a blank and 3 standards. The verification data must be within $\pm 10\%$ of the assigned values. If the data falls outside of this range, then the linearity of the instrument must be reestablished. If any portion of the curve is nonlinear, then sufficient standards must be used to clearly delineate the nonlinear portion of the curve.

NOTE: Samples with detections within 10% of highest calibration standard must be diluted.

- 14.9 **Contingencies for handling out-of-control QC.** Upon certain circumstances data can be reported from batches with QC non-conformances. Such samples are to be qualified accordingly. Examples include:

- If the MB is contaminated but the samples are non-detect, then the source of contamination should be investigated and documented. The sample results reported with appropriate qualifiers and footnotes. If the MB is contaminated but the samples results are > 10 times the contamination level, the source of the contamination should be investigated and documented. The samples results may be reported with the appropriate "B" or "V" qualifier. *This must be approved by the department supervisor.* Samples with hits < 10 times contamination are reprepped and reanalyzed. If there is insufficient sample to reanalyze, or if the sample is re-analyzed beyond hold time, the appropriate footnote and qualifiers should be added to the results. *This must be approved by the department supervisor*
- Similarly, if the recovery of LCS or CCV is high and the associated sample is non-detect, the data may be reportable with appropriate qualifiers and footnotes. If the recovery of LCS or CCV is below lower acceptance limit, the department supervisor shall review the data and determine what further corrective action is best for each particular sample. That may include reanalyzing the samples, re-prepping and/or reanalyzing the samples, or qualifying the results as estimated. *This must be approved by the department supervisor.* If there is insufficient sample to reanalyze, or if the sample is re-analyzed beyond hold time, the appropriate footnote and qualifiers should be added to the results. *This must be approved by the department supervisor.*

If the matrix spike recoveries are not within the established control limits, compare the recoveries to those of the LCS to assess method performance in clean QC matrix. Matrix spike recovery failures are not grounds for reanalysis but are an indication of the sample matrix effects

**CONTROLLED COPY
DO NOT DUPLICATE**

15.0 DOCUMENTATION REQUIREMENTS

- 15.1 All reagents must be recorded in a reagent logbook with manufacturers, lot numbers, and expiration dates. All reagent information must be cross referenced on the sample worksheet.
- 15.2 All instrument data must be exported to the LIMS system and a copy of the run log must be included in the logbook by the instrument.
- 15.3 A data package consisting of a manual run log, a LIMS run log, a calibration summary, batch quality control summary, and copies of all chromatograms must be turned into the area supervisor for each batch. The analyst should also complete the preliminary review in the LIMS system.
- 15.4 Refer to SOP QA029, current revision, for procedures and documentation that must be followed when peaks are manually integrated.

16.0 POLLUTION PREVENTION & WASTE MANAGEMENT

- 16.1 Users of this method must perform all procedural steps in a manner that controls the creation and/or escape of wastes or hazardous materials to the environment. The amounts of standards, reagents, and solvents must be limited to the amounts specified in this SOP. All safety practices designed to limit the escape of vapors, liquids or solids to the environment must be followed. All method users must be familiar with the waste management practices described in section 16.2.
- 16.2 Waste Management. Individuals performing this method must follow established waste management procedures as described in the waste management SOP, SAM108, current revision. This document describes the proper disposal of all waste materials generated during the testing of samples.

17.0 ADDITIONAL REFERENCES

- 17.1 Metrohm Instrument and column manuals
- 17.2 QA020 Method performance SOP, current revision
- 17.3 QA029 Manual Integration SOP, current revision.
- 17.4 QA042, General Chemistry Calculations, current revision
- 17.5 TNI 2016 standards.
- 17.6 DoD QSM, 5-series, current revision
- 17.7 Federal Register Vol. 77 No. 97
- 17.8 Metrohm AG document number 8.110.8010 "*IC Anion Suppressors*"

APPENDIX A: Sample Table Control Guideline

Sample Table Control: Initial Commands (Info 1)



Info 1 field used to specify initial (pre-analysis) commands

- **(01) Reset to First Auto-Vial**
 - Resets the auto-vial position to the Common Variable (01) First Auto-Vial
 - Used after placing new, empty dilution vials on the autosampler
 - Also restarts the Sample Counter
- **(02) Restart sample prep**
 - Used if an error occurs during the previous sample run
 - Causes the sample dilution to be prepared again in new auto-vial
 - **Best practice is to run a blank rather than utilize this command!**
- **(03) Initial rinse**
 - Rinse of sample flow path prior to analysis
 - Use when contamination from a high sample is suspected



Troubleshooting Tip

- Be sure to avoid mistakenly using the “(01) Reset to First Auto-Vial” command.
- This could lead to dilutions being made in used auto-vials.

Sample Table Control: i-Dilution Commands (Info 2)

➔ Info 2 field used to specify if a sample will be evaluated for an intelligent dilution

- **Blank (no entry)**
 - Sample will be evaluated for an intelligent dilution
- **“No intelligent dilution”**
 - Sample will NOT be evaluated for an intelligent dilution

The screenshot shows the 'Edit line - Working sample table - Workplace IC Bootcamp' dialog box. The 'i-Dilution Commands' dropdown menu is highlighted with a green box and set to 'No intelligent dilution'. Other fields include Method (MWDI 4.0_AnCat 940_UF_AREA_EPM), Ident (Blank), Sample type (Sample), Position (149), Injections (?), Volume (20 µL), Dilution (1), Sample amount (?), Initial Commands ((01) Reset to First Auto-Vial), Injection Commands (AnCat), Calibration Commands (New Anion Calibration), Instrument Dilution (1), Auto-Vial (84), and Batch name (?). The 'Info' button is visible at the bottom right.

Sample Table Controls: Calibration Reset (Info 4)

➔ Info 4 field used to specify when a new calibration is being performed

- **New Anion Calibration**
 - Resets Common Variable areas to zero for high standards

➔ **Troubleshooting Tip:**

- Do not use calibration reset commands unless performing a new calibration.
- Erroneous use will result in Common Variable areas being set to zero and will lead to incorrect intelligent dilutions.

The screenshot shows the 'Edit line - Working sample table - Workplace IC Bootcamp' dialog box. The 'Calibration Commands' dropdown menu is highlighted with a green box and set to 'New Anion Calibration'. Other fields include Method (MWDI 4.0_AnCat 940_UF_AREA_EPM), Ident (Blank), Sample type (Sample), Position (149), Injections (?), Volume (20 µL), Dilution (1), Sample amount (?), Initial Commands ((01) Reset to First Auto-Vial), i-Dilution Commands (No intelligent dilution), Injection Commands (AnCat), Instrument Dilution (1), Auto-Vial (84), and Batch name (?). The 'Info' button is visible at the bottom right.

Sample Table Controls: Instrument Dilution (Value 1)

⇒ Value 1 field used to specify the dilution the instrument is to perform

- **1:100 is the maximum dilution!**

The screenshot shows a software interface for editing a sample table line. The 'Instrument Dilution' field is highlighted with a green box and contains the value '1'. Other fields include Method (MVDI 4.0_AnCat 940_UF_AREA_EPM), Ident (Blank), Sample type (Sample), Position (149), Injections (1), Volume (20 µL), Sample amount (1), Initial Commands ((01) Reset to First Auto-Vial), I-Dilution Commands (No intelligent dilution), Injection Commands (AnCat), Calibration Commands (New Anion Calibration), Auto-Vial (84), and Batch name. The interface includes navigation buttons and 'Apply' and 'Close' buttons.

Sample Table Controls: Auto-Vial Position (Value 2)

⇒ Value 2 field used to serve as a reminder for which auto-vial positions to fill with clean, capped empty vials

- **This is not the actual position where dilutions will occur.**
- **It is a reminder to the user to load a sufficient number of empty vials on the sample processor.**
- **Actual current vial position can be found in the Configuration view under (03) Current Auto-Vial**
- **Numerical value must be between 84 – 148.**

The screenshot shows the same software interface as above, but with the 'Auto-Vial' field highlighted by a green box and containing the value '84'. All other fields and controls are identical to the previous screenshot.

Table 1 QC Criteria

Quality Control	Frequency	Acceptance Criteria	Corrective Action
Initial Calibration: r = coefficient of correlation	At least quarterly	≥0.995	Rerun calibration standards, and/or prepare new calibration standards and recalibrate the instrument, or document why the data are acceptable. See 11.9.2.
Initial Calibration Verification standard (ICV)	One per calibration	90-110% of the standard's true value	Rerun standard, and/or prepare new standard, and/or recalibrate instrument, or document why the data are acceptable. See 14.3
Continuing Calibration Verification standard (CCV)	Every tenth sample	90-110% of the standard's true value	Rerun standard, and/or recalibrate instrument and reanalyze all samples run since the last acceptable CCV, or document why the data are acceptable. See 14.6
Low-level Standard	One per calibration	50-150% of the standard's true value	Rerun standards, and/or recalibrate instrument and reanalyze all samples run since the last acceptable CCV, or document why the data are acceptable.
Method blank (MB) and Calibration Blank (CCB)	MB: One per batch CCB: Every tenth sample	< ½ RL Note: West Virginia state specific requirement for method blank must contain analyte at <MDL	Reanalyze, and/or stop the run and determine the source of contamination, or document why the data are acceptable.
Retention time	Checked weekly	90-110% of the standard's true value	Rerun standard, and/or recalibrate instrument and reanalyze all samples run since the last acceptable CCV, or document why the data are acceptable.
Blank Spike (BS or LCS)	One per batch	90-110%	Determine and correct the problem, reanalyze samples, if necessary, or document why data are acceptable.
MS/MSD	10% of matrix	90-110%	Determine and correct the problem, reanalyze samples and MS/MSD, or document why data are acceptable
Linear Calibration Range (LCR)	Bi-annually	± 10% of the standard's true value	Rerun and/or prepare new series of standard, and/or recalibrate instrument



DETERMINATION OF INORGANIC ANIONS BY ION CHROMATOGRAPHY

Prepared by: Robyn-Cherry Seigler Date: 12/21/2020

Approved by: Svetlana Izosimova Date: 12/21/2020

Annual Review

Reviewed by: _____ Date: _____

Reviewed by: _____ Date: _____

Reviewed by: _____ Date: _____

Document Control

Issued to: QA Department – digital Date: 12/21/2020

Issued to: General Chemistry Department – digital Date: * 12/21/2020

Issued to: _____ Date: _____

Issued to: _____ Date: _____

Issued to: _____ Date: _____

Issued to: _____ Date: _____

Effective 7 days after “*” date

**CONTROLLED COPY
DO NOT DUPLICATE**

TITLE: DETERMINATION OF INORGANIC ANIONS BY ION CHROMATOGRAPHY

REFERENCES: EPA 300.0, Revision 2.1, 1993; SW846 9056A; 40CFR, part 136, App. B – MDL procedure; Dionex Instrument and column manuals; SAM108, QA006, 020, 029, 034 and 042 current revisions; TNI 2016 standards; DoD QSM 5 – series

1.0 SCOPE & APPLICATION

This method is for the measurement of anions such as bromide, chloride, fluoride, nitrate, nitrite and sulfate by ion chromatography. The method is applicable to potable and non-potable water, solids after extractions, and neutral leachates.

2.0 SUMMARY OF METHOD

A small volume of sample is introduced into an ion chromatograph. The anions of interest are separated and measured, using a system comprised of a guard column, and analytical column, a suppressor, and a conductivity detector.

Detection limits vary with the instrument conditions and calibration levels used.

3.0 REPORTING LIMIT AND METHOD DETECTION LIMIT

3.1 Reporting Limit: The normal reporting limit for this method is normally established at or above the lowest non-zero concentration standard in the calibration curve. Detected concentrations below this concentration are not reported unless MDL reporting is being done. Reporting limits were set as follows:

<u>Analyte</u>	<u>Reporting Limit (mg/L)</u>
Bromide	0.50
Chloride	2.00
Fluoride	0.20
Nitrate	0.10
Nitrite	0.10
Sulfate	2.00

3.2 Method Detection Limit (MDL): Experimentally determine MDLs using the procedure specified in 40 CFR, Part 136, Appendix B. This value represents the lowest reportable concentration of an individual compound that meets the method qualitative identification criteria.

3.2.1 Experimental MDLs must be determined semiannually for this method, as outlined in EPA 300.0. Refer to SOP QA020, current revision, for further details.

4.0 DEFINITIONS

Batch: A group of samples which are similar with respect to matrix and the testing procedures being employed and which are processed as a unit. A sample batch is limited to a maximum of 20 samples or samples loaded on an instrument within the same 12-hour shift, whichever comes first.

Blank Spike (BS): An analyte-free matrix spiked with a known amount of analyte(s), processed simultaneously with the samples through all the steps of the analytical procedure. Blank Spike Recoveries are used to document laboratory performance for a given method. This may also be called a Laboratory Control Sample (LCS).

Continuing Calibration Verification (CCV): A check standard used to verify instrument calibration throughout an analytical run. CCV must be analyzed at the beginning of the analytical run, after every 10 samples, and at the end of the run.

Holding Time: The maximum times that samples may be held prior to preparation and/or analysis and still be considered valid.

Initial Calibration (ICAL): A series of standards used to establish the working range of an instrument and detector. The low point should be at a level equal to or below the reporting level.

Initial Calibration Verification (ICV): A standard from a source different than that used for the initial calibration. A different vendor should be used whenever possible. The ICV is used to verify the validity of an Initial Calibration. This may also be called a QC check standard.

Laboratory Information Management Systems (LIMS): The entirety of an electronic data system (including hardware and software) that collects, analyzes, stores, and archives electronic records and documents.

Matrix Spike (MS): A sample aliquot spiked with a known amount of analyte(s), processed simultaneously with the samples through all the steps of the analytical procedure. The matrix spike recoveries are used to document the bias of a method in a given sample matrix.

Matrix Spike Duplicate (MSD): A replicate sample aliquot spiked with a known amount of analyte(s), processed simultaneously with the samples through all the steps of the analytical procedure. The matrix spike duplicate recoveries are used to document the precision and bias of a method in a given sample matrix.

Method Blank (MB): An analyte-free matrix to which all reagents are added in the same volumes or proportions as used in sample processing. The method blank is processed simultaneously with the samples through all the steps of the analytical procedure. The method blank is used to document contamination resulting from the analytical process.

Method Detection Limits (MDLs): MDL is defined as the minimum concentration of a substance that can be measured and reported with 99% confidence that the analyte concentration is greater than zero and is determined from analysis of a sample in a given matrix containing the analyte. This definition is qualitative in nature and does not evaluate an acceptable quantitative limit for method performance. MDLs should be determined semiannually for every matrix in this method. Refer to SOP QA020, current revision.

Reagent Blank: The reagent blank is a blank that has the same matrix as the samples, i.e., all added reagents, but did not go through sample preparation procedures. The reagent blank is an indicator for contamination introduced during the analytical procedure. For methods requiring no preparation step, the reagent blank is equivalent to the method blank.

Reagent Grade: Analytical reagent (AR) grade, ACS reagent grade, and reagent grade are synonymous terms for reagents, which conform to the current specifications of the Committee on Analytical Reagents of the American Chemical Society.

Reagent Water: Water that has been generated by any method, which would achieve the performance specifications for ASTM Type II water.

Reference Material: A material containing known quantities of target analytes in solution or in a homogeneous matrix. It is used to document the bias of the analytical process.

Sample Duplicate (DUP): A replicate sample which is used to document the precision of a method in a given sample matrix.

Preservation: Refrigeration and/or reagents added at the time of sample collection (or later) to maintain the chemical integrity of the sample.

5.0 HEALTH & SAFETY

The analyst should follow normal safety procedures as outlined in the SGS Health and Safety Program which includes the use of safety glasses and lab coats. In addition, all acids are corrosive and should be handled with care. Flush spills with plenty of water. If acids contact any part of the body, flush with water and contact the supervisor.

The toxicity or carcinogenicity of each reagent used in this method has not been precisely determined; however, each chemical should be treated as a potential health hazard. Exposure to these reagents should be reduced to the lowest possible level. The laboratory is responsible for maintaining a current awareness file of OSHA regulations regarding the safe handling of the chemicals specified in this method. A reference file of data handling sheets should be made available to all personnel involved in these analyses.

6.0 COLLECTION, PRESERVATION AND HOLDING TIME

6.1 Samples must be cooled to $<6^{\circ}\text{C}$ at the time of collection.

6.2 Bromide, chloride, fluoride, and sulfate must all be analyzed within 28 days. Nitrite and nitrate must be analyzed within 48 hours for aqueous samples. For solids, the same hold time applies after the samples are prepared, with the exception of West Virginia. **Note:** West Virginia requires 48 hours from collection to completion for NO₂/NO₃, regardless of matrix.

7.0 APPARATUS AND MATERIALS

7.1 Ion Chromatograph with a guard column, an analytical column, a suppressor column, and a conductivity detector. This SOP is written for the use with the Dionex ICS-2000 or ICS-

2100 instrument. The ICS-2000 is run using prepared eluent. The columns used are listed below. Alternate columns may be used if all method requirements can be met.

Maintenance and troubleshooting procedures are described in detail in operation manual. Most basic procedures include checking connections for leaks, cleaning and/or replacing tubing, monitoring and recording the pressure. See Sec.12.0.

- 7.1.1 Suppressor, AERS 500 Carbonate 4mm. Dionex part number 085029.
- 7.1.2 Guard Column, IONPAC AG22 4 mm. Dionex part number 064139.
- 7.1.3 Analytical Column, IONPAC AS22. Dionex part number 064141. **Note:** Alternate columns and eluent combinations can be used. Follow manufacturer's recommendations.
- 7.1.4 Data System **Chromeleon 6.80 SR 10, build 2818**. Data system's revisions will be updated during annual SOP revisions. Data system changes prior to the date of revision are to be recorded in Maintenance log.
- 7.2 Top loading balance, capable of weighing to 0.01g. Calibrated and serviced annually by outside vendor and verified daily with Class 1 weights.
- 7.3 Analytical balance capable of accurately weighing to the nearest 0.0001 g.
- 7.4 Centrifuge Centra CL2, or equivalent.
- 7.5 Class 1 weights.
- 7.6 Volumetric glassware, class A.
- 7.7 IC vials and caps.
- 7.8 Volumetric pipettes, class A or autopipettors. **Note:** If autopipettors are used, make sure that the calibration is checked before use as specified in the autopipetter SOP QA006, current revision.
- 7.9 Nitrogen tank and regulator. In lieu of helium, any inert gas can be used to supply head pressure (e.g., UPH Nitrogen is sufficient). On the ICS-2000 and ICS-2100 instruments, nitrogen is used only for head pressure on the water reservoirs. The pressure should be set at approximately 6 psi.
- 7.10 Nylon 0.45µm membrane filters or equivalent.
- 7.11 Disposable syringes, for sample filtering.
- 7.12 Conductivity meter to pre-determine dilutions for possible interferences.

8.0 REAGENTS

All chemicals listed below are reagent grade unless otherwise specified. Deionized water must be used whenever water is required.

8.1 Stock Standard Solutions, custom mix standards that contain all target anions with a concentration range from 500mg/L to 10000mg/L: This custom standard can be purchased from various manufacturers such as High Purity Standard cat. # SM-205-001 and Inorganic Ventures cat.# acutttest-19.

Note: Levels shown below are suggested levels and may be changed to meet different reporting limit requirements.

8.2 The final concentrations of suggested standards are shown in the table below. All units are in mg/L.

Anion	STD A	STD B	STD C	STD D	STD E	STD F	STD G
F	.1	.5	1.5	2.5	5	7.5	10
CHL	2	10	30	50	100	150	200
NO2	.1	.5	1.5	2.5	5	7.5	10
BRO	.5	2.5	7.5	12.5	25	37.5	50
SO4	2	10	30	50	100	150	200
NO3	.1	.5	1.5	2.5	50	7.5	10

8.2.1 The volume of stock added to 100mL volumetric flask are shown in the table below. All volume units are in mL.

Anion	STD A	STD B	STD C	STD D	STD E	STD F	STD G
Custom mix	0.02	0.10	0.30	0.50	1.00	1.50	2.00

8.2.2 Alternatively, individual reagent stocks can be prepped. The table below shows how to prepare the Reagent stocks.

Anion	F	CHL	NO ₂	BRO	NO ₃	SO ₄
Amount weighed into 1L	2.2101g of NaF	2.1026g of KCl	X	1.2877g of NaBr	X	1.8140g of K ₂ SO ₄
Volume of 1000 mg/L Stock added into 50 mL	X	X	5 mL	X	5 mL	X
Anion Stock Concentration mg/L	1000	1000	100	1000	100	1000

8.3 The volume used of the anion stocks to prepare the calibration and its concentrations are in the tables below:

Volume of Reagent Stocks used for prep, in mL

Anion	STD A	STD B	STD C	STD D	STD E	STD F	STD G	STD H
F of 1000 mg/L	0.1	0.05	0.05	0.05	0.125	0.25	0.375	0.5
CHL of 1000 mg/L	2.0	1.25	1.0	1.0	2.5	5.0	7.5	10
NO2 of 100 mg/L	1.0	0.5	0.5	0.5	1.25	2.5	3.75	5
BRO of 1000 mg/L	0.5	0.25	0.25	1.25	0.625	1.25	1.75	2.5
NO3 of 100 mg/L	1.0	0.5	0.5	0.5	1.25	2.5	3.75	5
SO4 of 1000 mg/L	2.0	1.25	1.0	1.0	2.5	5.0	7.5	10
Total Volume	1L	250 mL	100 mL	50 mL	50 mL	50 mL	50 mL	50 mL

Calibration Standards Concentrations in mg/L

Anion	STD A	STD B	STD C	STD D	STD E	STD F	STD G	STD H
F	0.1	0.2	0.5	1.0	0.125	5.0	7.5	10
CHL	2.0	5.0	10	20	50	100	150	200
NO2	0.1	0.2	0.5	1.0	2.5	5.0	7.5	10
BRO	0.5	1.0	2.5	5.0	12.5	25	35	50
NO3	0.1	0.2	0.5	1.0	2.5	5.0	7.5	10
SO4	2.0	5.0	10	20	50	100	150	200

- 8.3.1 Continuing Calibration Verification (CCV): Same concentration as standard E.
- 8.3.2 ICV (External Check Solution): The ICV can be made in the same manner as the standard D from a different source than the ICAL standards. It must be within the range of the curve. Alternatively, it can be purchased from an outside supplier.
- 8.4 Stock Eluent (320mM Na₂CO₃, 100mM NaHCO₃): In a 250mL flask, add approximately 150mL of DI H₂O. Using oven dried reagent, dried at 105°C, (temperature should not exceed 110°C) weigh 8g of Na₂CO₃ and 2g of NaHCO₃, and add to flask. Bring this solution to volume. This solution is stable for 6 months stored refrigerated.
- 8.4.1 Eluent Solution (3.2mM Na₂CO₃, 1.0mM NaHCO₃): Dilute Stock Eluent – Sec. 8.4 using 20mL of stock in a 2000mL flask and bring up to volume. This solution is stable for a week stored refrigerated.
- 8.5 0.2N H₂SO₄ for suppressor regeneration: Pipet 1.0 mL of concentrated H₂SO₄ into 100mL DI and dilute to final volume of 200mL with DI.
- Note:** Alternate columns and eluent combinations can be used. Follow manufacturer’s recommendations.
- 8.6 0.1M Oxalic Acid for metals column clean-up: Dissolve 6.3g of oxalic acid into approx. 300mL of DI water. Bring to final volume of 500mL with DI water.
- 8.7 10X eluent concentrate for hydrophilic ionic contamination clean-up.

**CONTROLLED COPY
 DO NOT DUPLICATE**

- 8.8 Acetonitrile, reagent grade.
- 8.9 1M HCl: Add 8.3 mL of concentrated hydrochloric acid to approximately 70 mL of deionized water. Dilute to a final volume of 100 mL and mix well.

9.0 INTERFERENCES

- 9.1 Interferences can be caused by substances with retention times that are similar to and overlap those of the anion of interest. This interference is especially important at low concentrations.
- 9.2 The acetate anion elutes early during the chromatographic run and can cause elution times of other anions to vary when large amounts of acetate are present. High levels of acetate also can cause interference with the fluoride peak. Therefore, this method is not recommended for leachates containing acetic acid.
- 9.3 Large amounts of an anion can interfere with the peak resolution of an adjacent anion. High concentrations of an anion can also cause the peak to be misidentified on the chromatograph due to the large width of the peak. Sample dilution and fortification can be used to correct most interference problems connected with peak resolution.
- 9.4 Samples that contain particles greater than 0.45 μ m and reagents with particles larger than 0.2 μ m must be filtered to prevent damage to instrument columns and flow systems.

10.0 SAMPLE PREPARATION PROCEDURE

- 10.1 For soil samples, follow the preparation outlined below.
 - 10.1.1 Mix the sample well and remove any artifacts as discussed in SOP QA034, current revision. Weigh approximately 5g of sample and add 50mL of DI water. Mix or shake the resulting slurry for 10 minutes. Record the weight to the nearest 0.01g on preparation log.
 - 10.1.2 For matrix spikes, make sure to spike the aliquot of the sample directly and then add the volume of DI water needed to make the volume of liquid being added to the soil sample equal to 50mL including the volume of the spike solutions. In most cases this will be 49.75mL of DI.
 - 10.1.3 Prepare blank QC (Method Blank and Blank Spike) using a clean solid matrix, using approximately 5g aliquot and 50mL of DI water. Record the weight to nearest 0.01g.
 - 10.1.4 Check with the lab supervisor if there is insufficient sample to use a 5g aliquot. Smaller aliquots may be used if a homogeneous portion of the sample can be obtained. The sample must always be extracted with 10 times the sample weight of DI water.
 - 10.1.5 Centrifuge samples and QC for 10 minutes at 2000 RPM, then pre-filter through 0.45 μ m filters before analysis.

- 10.2 For aqueous samples, pre-filter water samples through 0.45µm filters only if they contain sediment or appear cloudy before analysis. Matrix spikes must be spiked before filtration. Pre-filter method blanks and blank spikes to act as QC check of the filters, only if there are samples in the batch that have been filtered. Record which samples have been filtered and the lot number of the filters in the run log. An unfiltered Method Blank and unfiltered Blank Spike are required for every batch of samples.

11.0 ION CHROMATROGRAPHY ANALYSIS PROCEDURE

- 11.1 Check to make sure that the helium tank pressure is > 100 PSI and the pressure gauge by the eluent bottles is set at 6 PSI.
- 11.2 Fill the eluent generation bottle(s) that are to be used with Eluent Solution- Sec. 8.4.1 making sure that they are pressurized with helium. On the instrument panel (or in the software) set the water volume at the level in the bottles and adjust the flow rate up to 1.0 mL/min.
- 11.3 Check the lines coming out of the suppressor for air bubbles. Bubbles should be present. If not, then check to make sure the current is on and the suppressor is working properly.
- 11.4 Check the pump waste line and see if bubbles are present. If they are present, then prime the pump using the procedure described below.
- 11.4.1 Verify that the priming valve on the primary pump head (right side) is closed. Hit the prime button on the front panel.
- 11.4.2 Follow the screen prompts. When prompted, open the waste valve by turning the knob ¼ to ½ turn counter-clockwise.
- 11.4.3 Check for air bubbles on the pump waste line. Continue priming until no air bubbles are exiting the waste line. Turn the pump off and then close the waste valve.
- 11.4.4 Allow the instrument conditions to settle and then check the pressure and check for air bubbles. If there is still a problem, the priming procedure may be repeated.
- 11.5 In the software, go to the browser and go to the correct instrument panel (1 or 2). Then connect the instrument. Monitor the baseline until it is stable.
- 11.6 Go to the template sequences and edit a sequence for the samples in the run. If a calibration is being used from an earlier run, make sure to copy the calibration into the front of the sequence. After the sequence is generated, then save it using the file name (instrument, date, run). Refer to the instrument manuals or help screens in the program for help in using the software. A summary of the instrument conditions required for the analysis of anions is shown below. **Note:** the retention time for each anion must not exceed +10% of that anions retention time from the calibration. Refer to section 14.7 for more discussion of the proper application of retention time.

Column: IonPac AG22, AS22
Eluent: 4.5mM Na₂CO₃, 1.4mM NaHCO₃

**CONTROLLED COPY
DO NOT DUPLICATE**

Suppressor setting: Approximately 30mAmps; this setting is auto generated
Flow rate: 1.0mL/min
Injection volume: 12.5µL
Pump pressure: Approximately 1600 psi
Detection: Suppressed conductivity, SRS Ultra II, external water mode

- 11.7 Check sample conductivity with a conductivity meter to determine if dilutions are needed. Refer to spreadsheet of possible dilutions stored on LAN in GenChem directory.
- 11.8 Load the autosampler and turn it on. The autosampler should then move to the first sample. A print-out of the autosampler table should be generated showing the order that the samples are loaded into the autosampler.
- 11.9 Start the run. Monitor the results as the run is going to make sure that problems are identified quickly. **Note:** The initial demonstration of capability, including instrument MDL's and linear calibration ranges, must be completed before samples can be run.
 - 11.9.1 Data files should be saved using the naming scheme of instrument, year (last 2 digits), month, day, run number followed by the extension of .txt. For example, the first IC run on instrument 2 on May 20, 2005 would be named 205052001.txt. This name should always be used in the workgroup description in the LIMS system.
 - 11.9.2 It is recommended that a new calibration be run a minimum of once per month (it is required that a calibration be run once per quarter). Calibrations standards may be varied from the one stated in this SOP depending on the levels of each anion that are to be reported. A minimum of 5 standards and a blank are required and a low standard must be at or below the reporting limit for each anion. A correlation coefficient of 0.995 or greater is required. If this correlation coefficient is not met, then the instrument must be recalibrated. Force to Origin (aka Force to Zero) is not permitted.
 - 11.9.2.1 Using weighed regression 1/concentration is also acceptable. Same correlation coefficient of 0.995 or better is required for this calibration model.
For greater details refer to SOP QA042, current revision.
 - 11.9.3 After the calibration, a low check at the reporting limit must be run. This low check must have the levels in standard A or at the reporting limit for the calibration outlined in this SOP and recoveries must be in the range of 50–150%. It is recommended that an external check is analyzed daily, and recoveries must be within a range of 90-110% (this check must be analyzed at a minimum with each new calibration). Continuing calibration checks and continuing calibration blanks must be run every 10 samples. The continuing calibration checks must have recoveries in the range of 90-110%. Refer to the quality control section of this SOP for more detail on these quality control samples.
- 11.10 After the run is completed, review all of the chromatograms and check for overlapping peaks, dilutions, etc.

- 11.10.1 If the retention time of any anion in the ICV or CCV check standards has shifted more than 10% from the original calibration curve retention time, then no results can be reported for that anion. The column should be reconditioned, if necessary, and the instrument recalibrated before any more samples are reported for that anion. Affected samples are reanalyzed after the problem has been corrected.
- 11.10.2 If a sample peak has shifted significantly from the original retention time (and the ICV and CCV check standards are within the 10% retention time window), then verify the reported result using post-digest spike on that sample. Do not report results from peaks where the retention time has shifted more than 10 percent unless the peak can be verified using a post-digest spike.
- 11.10.3 For large or overlapping peaks, make dilutions. If at all possible, make dilutions and reruns on the same run as the original sample.
- 11.10.4 Refer to section 14.7 for information on how to determine the appropriate retention time window.
- 11.11 Review all data and update the appropriate tests in the LIMS system. A write-up including a run log, a calibration summary, batch quality control summary, and copies of all chromatograms should be turned into the area supervisor for each batch.
 - 11.11.1 If edits are needed in the calibration after the data has been calculated, the run can be reprocessed using the batch function in the software. Refer to the instrument manuals or on-screen help for additional information.

12.0 INSTRUMENT MAINTENANCE

- 12.1 Whenever a new suppressor is put in place or when the baseline is unstable or very high, the suppressor should be regenerated. The procedure below is for the Ultra 4mm suppressor.
 - 12.1.1 Using a disposable plastic syringe, push approximately 3mL of 0.2N (200mN) H₂SO₄ through the ELUENT OUT port and 5mL of 0.2N H₂SO₄ through the REG IN port respectively.
 - 12.1.2 Allow the suppressor to sit for approximately 20 minutes to fully hydrate the suppressor screens and membranes.
 - 12.1.3 Re-connect the suppressor to the system in the recycle mode.
- 12.2 Periodically, due to the matrix of samples, both guard and analytical columns become degraded and cleaning them becomes necessary. This is evidenced in changing retention times, round-shaped peaks, tailing peaks and overall poor integration. The metals cleanup should be done a minimum of once per month, while the others should be done a minimum of once per quarter.
- 12.3 There are 3 recommended cleanup solutions for the AS22 and AG22 columns.

- 12.3.1 Metal contamination column clean-up: Use 500mL of 0.2M oxalic acid solution.
- 12.3.2 Low valency hydrophilic ionic contamination column clean-up. Use 500mL of 10X eluent concentrate (300 mM KOH).
- 12.3.3 High valency hydrophobic ion 200mM HCl in 80% acetonitrile: The acetonitrile solution is stored in a separate eluent bottle because acetonitrile slowly breaks down in acidic aqueous solutions. Prepare 2 bottles (E1 and E2) with the following 500mL solutions: E1: 100% Acetonitrile and E2: 1M HCl using DI water.

12.4 Column Clean-up Procedure

- 12.4.1 Prepare 500mL solution of the appropriate cleanup solution from 12.3.
- 12.4.2 Disconnect the suppressor from the IonPac AS22 Analytical column. **Make sure to reverse the order of the guard and analytical column in the eluent flow path.** Contaminants that have accumulated on the guard column can be eluted onto the analytical column and irreversibly damage it. Cleaning each column separately is recommended. Double check that the eluent flows in the direction designated on each of the column labels.
- 12.4.3 Set the pump flow rate to 1.0mL/min for an AS22 4-mm analytical or guard column.
- 12.4.4 Rinse the column for 15 minutes with DI water before pumping the chosen cleanup solution over the columns.
- 12.4.5 Pump the cleanup solution through the column for at least 60 minutes.
- 12.4.6 Rinse the column for 15 minutes with DI water before pumping eluent over the column.
- 12.4.7 Equilibrate the columns with eluent before resuming normal operation for at least 30 minutes.
- 12.4.8 Reconnect the suppressor and place the guard column in line between the injection valve and the analytical column.

13.0 METHOD PERFORMANCE

Method performance (accuracy and precision) is monitored through the routine analysis of negative and positive control samples. These control samples include method blanks (MB), blank spikes (BS), matrix spikes (MS), and matrix spike duplicates (MSD). The MB and BS are used to monitor overall method performance, while the MS and MSD are used to evaluate the method performance in a specific sample matrix.

Blank spike, matrix spike, and matrix spike duplicate samples are compared to method defined control limits. Control limits are stored in the LIMS. Additionally, blank spike accuracy is regularly evaluated for statistical trends that may be indicative of systematic analytical errors.

Filtered method blanks and blank spikes to act as QC check of the filters. Unfiltered method blanks and blank spikes are used to monitor overall method performance.

14.0 QC REQUIREMENTS

14.1 A method detection limit study must be done semiannually, or when new operator begins work, or whenever there is a significant change in the background or instrument response. The MDL study is done following the procedure outlined in the SGS – Orlando SOP QA020, current revision. A minimum of seven replicates spiked at 3 to 5 times the MDL must be taken through the procedure for each anion. If instrument conditions (columns, etc.) are modified, then a new MDL must be done.

14.2 A method blank and a spike blank are required to be run with every batch of 20 samples. Additionally, a matrix spike and a matrix duplicate are required for every 10 samples. In some cases, a matrix spike duplicate may be required in place of a duplicate.

14.2.1 The method blank must contain $< \frac{1}{2}$ RL of each anion that is reported, and this sample must be run with each set of samples in a batch. If the blank contains more than the reporting level, then all samples must be reanalyzed. If no sample volume remains to be reanalyzed, then the data must be flagged (the exception is if the sample results are less than the reporting limit).

Note: West Virginia state specific requirement for method blank must contain analyte at $< \text{MDL}$.

14.2.1.1 Although the method states that values greater than the MDL should be suspect, this is not appropriate for the concentration levels being applied for this analysis. MDL's are generally up to 10 times lower than reporting limits for all analytes and values over the MDL do not impact data usability.

14.2.2 The recovery of the spike blank must be within the limits of 90-110% recovery for each anion that is reported, and this sample must be run with each set of samples in a batch. If the recoveries are outside of this range, then all associated samples must be reanalyzed. If no sample volume remains to be reanalyzed, then the data must be flagged.

14.2.3 The matrix spike is spiked with all anions of interest. Method limits of 90-110 % recovery must be applied. Control limits must be generated from laboratory data to support method limits. If the recoveries are outside of this range, and all other method quality control is within limits, then matrix interference should be suspected.

14.2.4 For matrix duplicates control limits of 10% RPD must be applied for all sample values within the calibration range (up to 10 times the reporting limit). If the RPD values are outside of this range, and all other method quality control is within limits, then sample non-homogeneity should be suspected.

14.3 An external source standard (ICV) must be analyzed after every new calibration and its recovery must be within 10% of the true value. If the ICV is not within $\pm 10\%$, a second ICV should be prepared and analyzed. If the ICV is still outside of the limits, sample analysis

must be discontinued and the cause determined (preparation of ICV from third source, instrument recalibration, etc.).

- 14.4 It is recommended that a new calibration be run a minimum of once per month (it is required that a calibration be run once per quarter). Calibration standards may be varied from the one stated in this SOP depending on the levels of each anion that are to be reported. A minimum of 5 standards and a blank are required and a low standard must be at or below the reporting limit for each anion. A correlation coefficient of 0.995 is required.
- 14.4.1 A new calibration is required when standard retention times shift by more than 10% from the original calibration.
- 14.5 A low check at the reporting limit (CCV2) for each anion must be run after each calibration. Acceptance criteria is 50–150%.
- 14.6 CCVs at or near the mid-level of the curve must be run at the beginning and the end of the run and after every 10 samples throughout the run. Every CCV must be followed by a continuing calibration blank (CCB). The CCV must have results within 90-110% of the true value. If the CCV results are outside of the acceptance criteria range, analyst must demonstrate acceptable performance with two CCVs analyzed immediately (started within 1 hour), with no samples between failing CCV and the two additional CCVs. The results for the CCB must be <1/2 RL for an analyte. If they are not, then all bracketed samples for that analyte must be reanalyzed.
- 14.7 Retention time windows must be established whenever a new column/guard column is installed in an instrument or whenever a major change has been made to an instrument. Retention time shift is checked weekly with a CCV to ensure it does not exceed 10%, and the data is stored on LAN in GenChem directory.

Retention time windows are established by injecting standard mix three times over the course of 24 hours and calculating the standard deviation of the retention times of each analyte. Plus or minus three times the standard deviation of the retention times is defined as the retention time window of that compound.

Peak identification is based on the retention time of an analyte in the standard (initial or continuing) being used as the mid-point of the retention time window. The retention time windows should be used as a guide for identifying compounds; however, the experience of the analyst should weigh heavily in the interpretation of the chromatograms. The analyst should monitor the retention times of known standard peaks throughout an instrument run as an indication of instrument performance.

Because calculated retention time windows are generally very tight (less than ± 0.10 minutes), the retention time windows for the data processing method are generally set wider than the calculated window. This is done to ensure that the software does not miss any potential "hits". The analyst will then review these "hits" and determine if the retention times are close enough to the retention time of the target analyte to positively identify the peak or to require confirmation.

- 14.8 The Linear Calibration Range (LCR) is the concentration range the instrument response is linear and must be initially determined and verified every 6 months or whenever a significant change in the instrument is observed or expected. Initially, enough standards must be used to insure the curve is linear. The linearity verification must use at a minimum, a blank and 3 standards. The verification data must be within $\pm 10\%$ of the assigned values. If the data falls outside of this range, then the linearity of the instrument must be reestablished. If any portion of the curve is nonlinear, then sufficient standards must be used to clearly delineate the nonlinear portion of the curve.

Note: Samples with detections within 10% of highest calibration standard must be diluted.

14.9 Contingencies for Handling Out-of-Control QC

Upon certain circumstances data can be reported from batches with QC non-conformances. Such samples are to be qualified accordingly. Examples include:

- If the MB is contaminated but the samples are non-detect, then the source of contamination should be investigated and documented. The sample results reported with appropriate qualifiers and footnotes. If the MB is contaminated but the samples results are > 10 times the contamination level, the source of the contamination should be investigated and documented. The samples results may be reported with the appropriate "B" or "V" qualifier. *This must be approved by the department supervisor.* Samples with hits < 10 times contamination are re-prepped and reanalyzed. If there is insufficient sample to reanalyze, or if the sample is re-analyzed beyond hold time, the appropriate footnote and qualifiers should be added to the results. *This must be approved by the department supervisor.*
- Similarly, if the recovery of LCS or CCV is high and the associated sample is non-detect, the data may be reportable with appropriate qualifiers and footnotes. If the recovery of LCS or CCV is below lower acceptance limit, the department supervisor shall review the data and determine what further corrective action is best for each sample. That may include reanalyzing the samples, re-prepping and/or reanalyzing the samples, or qualifying the results as estimated. *This must be approved by the department supervisor.* If there is insufficient sample to reanalyze, or if the sample is re-analyzed beyond hold time, the appropriate footnote and qualifiers should be added to the results. *This must be approved by the department supervisor.*

- 14.9.1 If the matrix spike recoveries are not within the established control limits, compare the recoveries to those of the LCS to assess method performance in clean QC matrix. Matrix spike recovery failures are not grounds for reanalysis but are an indication of the sample matrix effects.

15.0 DOCUMENTATION REQUIREMENTS

- 15.1 All reagents must be recorded in a reagent logbook with manufacturers, lot numbers, and expiration dates. All reagent information must be cross referenced on the sample worksheet.

- 15.2 All instrument data must be exported to the LIMS system and a copy of the run log must be included in the logbook by the instrument.
- 15.3 A data package consisting of a manual run log, a LIMS run log, a calibration summary, batch quality control summary, and copies of all chromatograms must be turned into the area supervisor for each batch. The analyst should also complete the preliminary review in the LIMS system.
- 15.4 Refer to SOP QA029, current revision, for procedures and documentation that must be followed when peaks are manually integrated.

16.0 POLLUTION PREVENTION & WASTE MANAGEMENT

- 16.1 Users of this method must perform all procedural steps in a manner that controls the creation and/or escape of wastes or hazardous materials to the environment. The amounts of standards, reagents, and solvents must be limited to the amounts specified in this SOP. All safety practices designed to limit the escape of vapors, liquids or solids to the environment must be followed. All method users must be familiar with the waste management practices described in section 16.2.
- 16.2 Waste Management: Individuals performing this method must follow established waste management procedures as described in the waste management SOP, SAM108, current revision. This document describes the proper disposal of all waste materials generated during the testing of samples.

REVISION HISTORY

Revision Date	Revision Number	Affected Section(s)	Revision Description
12/2020	10	Entire Document	Added Revision History and removed Revised Sections. Updated entire document to current SOP format. Removed Additional References section and moved references to References section. Added " Note: Alternate columns and eluent combinations can be used. Follow manufacturer's recommendations." to section 7.1.3 and 8.5. Grammar, punctuation and spelling updated as needed.

Table 1: QC Criteria

Quality Control	Frequency	Acceptance Criteria	Corrective Action
Initial Calibration: r = coefficient of correlation	At least quarterly	≥0.995	Rerun calibration standards, and/or prepare new calibration standards and recalibrate the instrument, or document why the data are acceptable. See 11.9.2.
Initial Calibration Verification standard (ICV)	One per calibration	90-110% of the standard's true value	Rerun standard, and/or prepare new standard, and/or recalibrate instrument, or document why the data are acceptable. See 14.3.
Continuing Calibration Verification standard (CCV)	Every tenth sample	90-110% of the standard's true value	Rerun standard, and/or recalibrate instrument and reanalyze all samples run since the last acceptable CCV, or document why the data are acceptable. See 14.6.
Low-level Standard	One per calibration	50-150% of the standard's true value	Rerun standards, and/or recalibrate instrument and reanalyze all samples run since the last acceptable CCV, or document why the data are acceptable.
Method blank (MB) and Calibration Blank (CCB)	MB: One per batch CCB: Every tenth sample	< ½ RL Note: West Virginia state specific requirement for method blank must contain analyte at <MDL	Reanalyze, and/or stop the run and determine the source of contamination, or document why the data are acceptable.
Retention time	Checked weekly	90-110% of the standard's true value	Rerun standard, and/or recalibrate instrument and reanalyze all samples run since the last acceptable CCV, or document why the data are acceptable.
Blank Spike (BS or LCS)	One per batch	90-110%	Determine and correct the problem, reanalyze samples, if necessary, or document why data are acceptable.
MS/MSD	10% of matrix	90-110%	Determine and correct the problem, reanalyze samples and MS/MSD, or document why data are acceptable
Linear Calibration Range (LCR)	Bi-annually	± 10% of the standard's true value	Rerun and/or prepare new series of standard, and/or recalibrate instrument



SAMPLE RECEIPT AND STORAGE

Prepared by: Svetlana Izosimova Date: 03/12/2020

Approved by: Heather Wandrey Date: 03/12/2020

Annual Review

Reviewed by: Heather Wandrey Date: 3/12/2020

Reviewed by: _____ Date: _____

Reviewed by: _____ Date: _____

Document Control

Issued to: QA Department Date: 03/12/2020

Issued to: Sample Management Date: * 03/12/2020 digital

Issued to: _____ Date: _____

Issued to: _____ Date: _____

Issued to: _____ Date: _____

Issued to: _____ Date: _____

Effective 7 days after "*" date

TITLE: SAMPLE RECEIPT AND STORAGE

REFERENCES: TNI Standards 2009 and 2016, State of Florida DEP SOPs, 40 CFR Part 136, DoD QSM 5-series; SOP QA020, Subcontracting, current revision.

REVISED SECTIONS: Revised SOP name to original convention; added Attachments II, III and IV; added reference to SOP QA021, Subcontracting; Added sec. 2.2.8, referencing subcontracting process in SOP QA021; changed location of Foreign Soil storage to a stand-alone cooler #14 (2.10.2)

1.0 SCOPE AND APPLICATION

To maintain documentation of custody of all bottle sets, samples (domestic and foreign), digestates, distillates, and extracts that fall under the responsibility of SGS North America, Inc. - Orlando.

2.0 EXTERNAL CHAIN-OF-CUSTODY PROCEDURE

2.1 Samples are received via commercial carrier, client delivery, or are picked up by SGS - Orlando employees. Upon receipt, sample management inspects the outside of the container for signs of tampering, such as a torn or missing custody seal. The staff reviews Chain Of Custody (CoC) document for the following information:

2.1.1 Client Information- Name / Address, Phone and Fax contact numbers

2.1.2 Facility Information- Project name, Location, Project Number.

2.1.3 Field ID / Point of Collection- Date- Time- (HOLD TIMES) Samplers Initials- # of containers Shipped, Preservative types.

2.1.4 Matrix of samples: WW- water, GW-ground water, SW-surface water, DW-drinking water, SO-Soil, SOL-other solid, LIQ-other liquid, OI- Oil, AIR-air, WP- Wipe, FB-field blank, TB-trip blank.

2.1.5 Analytical Information- Samples with hold times of 72 hrs or less remaining on analyses upon receipt are considered Short Hold Samples and are listed on Short Hold Notification form in order of hold times, from ASAP to 7 days with less than 3 days left. These samples are processed immediately. Job Numbers are assigned, and the samples are given directly to the appropriate lab. Copy of CoC and completed Short Hold Notification Form are relinquished to the appropriate lab by the sample receiving technician. Laboratory personnel accept the samples, time of transfer is recorded, both parties sign SHNF and a copy of the SHNF is attached to CoC. (See Attachment I, Short Hold Notification Form, and Attachment IV, for container types and sizes, hold times and required preservatives.)

**CONTROLLED COPY
DO NOT DUPLICATE**

- 2.1.5.1 VOC soil sample vials must be frozen within 48 hours of collection. Receiving technicians review sample times and deliver samples with a SHNF if sufficient hold-time remains to process the samples. If samples are close to expiring the samples are immediately placed in the freezer with a card notating the time they were placed in the freezer. (See Attachment II, listing of tests associated with the requirement)
- 2.1.6 TURN AROUND TIME- Samples with a 6 day or less TAT are processed as soon as possible, depending on samples with short hold status.
- 2.1.7 Sample custody documentation signatures – relinquished/received in Client – Carrier – Laboratory sequence. Per FL DEP SOPs signature shall consist of full signature – no initials allowed – and business affiliation.
- 2.1.8 Special Requirements and or comments - Compositing, filtering or preservation of samples, Extended sample storage etc.
- 2.2 Samples are processed by a two-technician team, The sample custodian(s) accepts sample custody upon receipt of samples and verifies that the custody document is correct. Sample conditions, sample temperature, and other observations, including custody seal condition, are documented in detail on the electronic Sample Receipt Confirmation form (p-note).
- 2.2.1 Temperature is measured using IR thermometer against white label on temperature blank, or on the sample container, if temperature blank is absent. **NOTE: For jobs originated in West Virginia every sample container must be checked.** This thermometer is calibrated measuring the temperature off of white sample label against NIST-traceable liquid-in-glass thermometer – see SOP QA002, current revision. When recording the cooler temperature with the use of an IR gun the following needs to be documented on Sample Receipt Confirmation Form:
- 2.2.1.1 IR gun used.
- 2.2.1.2 Correction factor.
- 2.2.1.3 Observed cooler temperature.
- 2.2.1.4 Corrected cooler temperature.
- 2.2.2 Verify IR thermometer correction factor gains Correction factor recorded in Receipt utility to make sure it is correct in both locations. Notify QA/Department Manager if these values are not the same. Apply temperature correction factor for a face value – positive number to be added to direct reading temperature, negative correction factor to be subtracted.
- 2.2.3 **Samples must remain in coolers full of ice until it is time to process the job for login. Coolers received out of temperature range have initial temperature recorded and are then placed into a Walk-In cooler until resolution from client is received.** 40 CFR part 136, TNI Standards 2009, 2016 revision and DoD QSM 5.1 all designate acceptable temperature as “above freezing and below 6°C”.

Temperature is measured and recorded to first decimal place due to state-specific and client-specific requirements.

- 2.2.4 Any discrepancies or non-compliant situations are documented on the Sample Receipt Confirmation Form (p-note) which is automatically e-mailed to the SGS - Orlando Project Manager (PM) team. PM assigned to the particular client contacts the client for resolution. Major issues require the client to be contacted before the samples can be logged in, such as but not limited to missing COC's, samples being out of hold, insufficient sample volume, bottles received not on COC or out of temperature range. If resolution of the problem is taking time, the samples are labeled as is and placed into refrigerated storage until the problems are resolved. Samples are then removed and processed according to client's instructions. Minor issues identify discrepancies that do not interfere with log-in and/or analysis of the samples, such as 1 of 2 PAH bottles received broken or supplied. The resolution is documented and communicated to sample management for execution.
- 2.2.5 Once the sample custodian(s) is (are) satisfied with the information on the chain of custody document, the job number is generated from Receipt access-based utility with the next available SGS - Orlando sequential job ID in FXXXXXX convention.
- 2.2.6 First technician arranges samples on the counter in the order of CoC. Every different point of collection must have a different fraction number, i.e. -1, -2, etc. The assigned fraction number must be written on the chain of custody, to the left of the line identifying the point of collection (Client ID) unless there is insufficient space. The custodian then assigns a unique sample identifier to each sample container, i.e. FAXXXX-1.4, where 4 is a unique container designation.
- 2.2.7 The same technician enters samples in the sample location database and prints the labels for the samples. A second technician then attaches the labels to the samples and re-verifies sample client ID and Lab fraction number against CoC. After all the steps in Sec. 3 are completed, first technician closes the Sample Receipt Confirmation Form and second technician reviews it for completeness and accuracy of recorded information.
- 2.2.7.1 Wherever samples are designated to be put on hold by the client, labels on these samples are highlighted in bright pink and additional bright pink "HOLD – Do Not Dispose" label is attached to the individual containers.
- 2.2.8 Identify samples with subcontracted parameters and process according to SOP QA021, current revision. Most common, but not limited to, subcontracted parameters are listed in Attachment III.
- 2.2.9 **After Hours Delivery Procedure.** Upon return to the lab SGS - Orlando-employed couriers will visually inspect the coolers and add ice if needed. Coolers will then be placed into Refrigerated storage until Sample Receiving Technicians can process the coolers. Sample Receiving technicians will arrive first thing in the morning to verify Short Holds, Rushes etc as per sec. 3.1.5 and 3.1.6.

- 2.3 When assigning a job number, the following information from the chain of custody is entered in the Access Receipt utility:
- 2.3.1 SGS - Orlando Assigned Job #
 - 2.3.2 Client Name
 - 2.3.3 Project Name
 - 2.3.4 Date and Time Samples Received.
 - 2.3.5 # of coolers Received.
 - 2.3.6 Courier Information
 - 2.3.7 Technician Initials
- 2.4 The sample custodian then checks the samples' preservation, except for the volatile samples, which are checked by the analyst after the sample is analyzed. Should a sample be received preserved incorrectly the following actions are taken:
- 2.4.1 pH and residual chlorine: For samples requiring preservation (HNO₃, H₂SO₄, NaOH and NaOH/Zn Acetate) each container is tested by applying the sample with disposable capillary to narrow-range pH paper. Residual chlorine presence/absence is measured using potassium iodide/starch paper in all samples with EPA 600-series methods indicated on CoC and samples originated in North Carolina (one bottle per well). 45-ml VOC vials are exempt from this procedure and are being tested in the lab after the requested tests are completed (purge-and-trap GC and GC/MS, TOC/TC and EPA 504/8011).
 - 2.4.2 Pesticides/PCB's/Semivolatile Organic aqueous samples with residual chlorine present: Immediately request an appropriate amount of 8% sodium thiosulfate solution to be prepared by WetChem department. Segregate affected samples on a cart in a walk-in cooler until solution is received. Add 1 ml of 8% sodium thiosulfate solution per 1liter (0.008%) to all containers except VOA. Record event on Sample Receipt Confirmation Form and in preservative adjustment log.
 - 2.4.3 Organochlorine pesticides and PCBs by EPA 608 - samples that are not extracted within 72 hours of collection need to have pH checked and adjusted, if necessary, to a pH within 5.0-9.0 using H₂SO₄ or NaOH. Coordinate with Extraction department.
 - 2.4.4 Cyanide is preserved to pH ≥ 12 using 10N NaOH, prepared by WetChem personnel.
 - 2.4.5 Sulfide is preserved to pH ≥ 9 using 10N NaOH and Zn acetate, prepared by WetChem personnel.
 - 2.4.6 Aqueous samples for metals are preserved to pH ≤ 2 with nitric acid, prepared by WetChem Personnel. These samples are marked with colored label "**Metals Sample Received Unpreserved. Preserved Date_____Time_____ Analyze after 24 hours**". For correctly preserved aqueous metals sampling date and time from COC is recorded as date and time of preservation.
 - 2.4.7 Aqueous samples for TRPH and some WetChem parameters are preserved to a pH of ≤2 with H₂SO₄, prepared by WetChem Personnel.

**CONTROLLED COPY
DO NOT DUPLICATE**

- 2.4.8 To avoid using expired preservatives, in the beginning of the calendar month obtain no more than 100 ml of currently used preservative reagents from Shipping area, appropriately label the container with reagent identity and expiration date and discontinue its use at the end of the month. Turn unused portion to the Waste room for further disposal.
- 2.5 Incorrectly preserved samples have the proper amount of preservative added, upon confirmation from PM or client, volume added is recorded on the Sample Receipt Confirmation form and in preservative adjustment log. The same volume and type of preservative is then added to the Equipment Blank and/or Field Blank, regardless of pH reading. Volume added is recorded on the Sample Receipt Confirmation form and in the preservative adjustment log. Also see Sec. 3.4.5.
- Job Number, Sample ID, Bottle Number, Parameter, Preservative Type, Preservative Lot, and Amount of Preservative Added, Date/Time Added and the technician's initials.
- 2.6 All bottles must be labeled. Each bottle will be labeled both on the cap and on the bottle. . The labels are generated by the electronic sample receipt log. The following information is entered into the electronic log:
- 2.6.1 Job #:
 - 2.6.2 Client Name and Project
 - 2.6.3 Date and time samples were received.
 - 2.6.4 The number of coolers received
 - 2.6.5 The temperature of each cooler
 - 2.6.6 Initials of custodian logging in the job
 - 2.6.7 Number of samples
 - 2.6.8 Number of bottles
 - 2.6.9 Bottle type
 - Preservative by code. From pull down menu in the receiving app.
 - 2.6.10 Bottle storage location
 - 2.6.11 Department to do the analysis
 - 2.6.12 The information is saved and labels can be printed.
- 2.7 The following information must be on the bottle:
- 2.7.1 The sample number and bottle number
 - 2.7.2 Storage location
 - 2.7.3 The preservative used during sampling as indicated on the chain
- 2.8 The samples must be placed in their assigned locations and kept at above freezing and below 6.0°C until preparation and/or analysis. Water samples preserved with HNO₃ for metals analyses are stored at room temperature. Access to the area is limited.
- 2.9 The original chain of custody and any additional documented information relative to the job is then placed in a bin in receiving for the Login personnel to pick up for entry into LIMS.

- 2.10 **Foreign samples** are referred to samples originated outside of continental United States. These samples must be segregated from domestic samples in storage, processing and disposal. Objective of such segregation is to keep agricultural pests and pathogens from entering continental US territory and interfering with animal and plant health.
- 2.10.1 Foreign Samples shall be shipped in securely closed watertight containers and free of debris and macro organisms (insects, mollusks, worms, ticks and mites).
- 2.10.2 Foreign samples are stored in lockable cooler #14 to prevent accidental disposal. This cooler is clearly marked *for foreign samples only*. Sample labels are colored green to stand out in the lab departments.
- 2.10.3 Keep lids tightly closed while in storage.
- 2.10.4 All unconsumed samples and containers must be separately collected for disposal. SGS - Orlando employs outside contractor to sterilize and dispose of foreign samples – see SOPs SAM108 and SAM109, current revision.

3.0 SAMPLE STORAGE TEMPERATURE AND CROSS-CONTAMINATION MONITORING

- 3.1 While in the laboratory, samples shall be stored in limited-access, temperature –controlled areas. Refrigerators shall be monitored for temperature daily. Acceptance criteria for the temperature of refrigerator is 0.5 to 6.0 °C * and is listed in the refrigerator log. Thermometers that have been calibrated with a NIST traceable thermometer monitor all cold storage areas. As indicated by the finding of the calibration, a correction factor is applied to each thermometer for a face value. Records that include acceptance criteria shall be maintained.
- *According to TNI 2009 and 2016, V1M2, sec. 5.8.9.a.i) temperature should be above freezing point and below 6.0°C, when specified storage temperature is 4°C. Lowest temperature that can be practically read above freezing point is 0.5°C.
- 3.2 Samples for volatile organics determination shall be stored separately from other samples, standards, and sample extracts. Acceptance criteria for the temperature of a volatile refrigerator is 0.5 to 6.0 °C and is listed in the refrigerator’s log. VOC Soil freezers are maintained between –10.0°C and -20.0°C per SW-846 5035A. For further details refer to SOP QA004, current revision.
- 3.3 Sample storage area for volatile organics shall be monitored for cross contamination using refrigerator blanks. Refrigerator blanks shall be analyzed every other week.
- 3.3.1 If contamination of the refrigerator is confirmed, the samples must be removed from the refrigerator and placed in coolers with ice, or in alternate refrigerated storage.
- 3.3.2 All samples received after the date of the last clean refrigerator blank must be checked for the same contaminants. If present, they must be reported and flagged with a qualifier indicating possible lab contamination.

- 3.3.3 The source of the contamination must be located and removed.
- 3.3.4 A new refrigerator blank is then placed in the refrigerator and analyzed after 24 hours.
- 3.3.5 Samples may be returned to the refrigerator when all contaminants are removed as indicated by the analysis of a refrigerator blank without contamination.

4.0 DOCUMENTATION

All samples received by SGS - Orlando must come with a chain-of-custody (COC). Special attention shall be paid to client-specific COCs.

SGS - Orlando personnel **MUST** record dates and time in **mm/dd/yy 24:00** format, and both observed and corrected temperatures.

Current revisions of forms and label templates used in sample receipt process are maintained as controlled documents in limited access directory on LAN.

Attachment I

SHORT HOLD NOTIFICATION FORM **JOB #** _____

<u>HOLD TIME</u>	<u>ANALYTE</u>	<u>CHECK COC</u>	<u>COMMENTS</u>
ASAP	RedOx		
	Bacteria- Total Coliform/Fecal Coliform		
24 hrs	XCr / Hexachrome / Cr +6		
	Dissolved/Filtered Metals		
	Odor		
	Salinity (SCON+ Field Temp & Pressure)		
48 hrs	BOD		
	CBOD		
	MBAS		
	Turbidity		
	Color		
	Nitrate (NO3)		
	Nitrite (NO2)		
	TN (NO2/NO3)		
	OPO4 / Orthophos		
	SS (Settleable Solids)		
	Chlorophyl A (Subcontract)		
72 hrs	Acrolein/Acrylonitrile (VOA from Alaska)		
	Formaldehyde (Subcontract)		
7 days Only for samples received after 5 days	Unpreserved Voa Vials		
	TDS/TSS/TS		
	Sulfide		
	8141 pesticides in soil		
	All the Water extractables		
Soils			
48 Hours	5035 Field Kit (DI vials)		
	Encore Sampler VOA/VPH/GRO		
	Soil Jar (Bulk Sample) VOA/VPH/GRO		
	NO2/NO3 from WV (IC analysis)		

Relinquished by: _____ Date/Time relinquished: _____

Received by: _____ Date/Time received: _____

Attachment II

SOIL SAMPLES

Samples associated with tests listed below need to be brought to Volatile Soil Prep or Frozen within 48 hours from Date/Time of Sampling.
This requirement applies to soil Jars, 5035 Field Kits, Encores and Terracores

8260

8021

GRO

OK GRO

KS GRO

VPH

OA1

VOA

VOC

VOH

PRE-BURN

8015

5035

5030

TN GRO

MO GRO

Attachment III

SUBCONTRACT ANALYSES

**BELOW IS A LIST OF THE MOST COMMON SUB PARAMETERS BUT IT IS
NOT INCLUSIVE**

TOX

TOC-SOILS

GROSS ALPHA, GROSS BETA (GR-A, GR-B)

Radium 226/228 (R-226/R-228)

ASBESTOS

CO2 (VIALS ONLY)

URANIUM (U)

60ML- PFAS (537 BOTTLES)

B-BORON

LI-LITHIUM

Attachment IV ORGANIC ANALYSIS

ANALYSIS	ANALYTICAL METHOD	MATRIX	MINIMUM VOLUME	CONTAINER TYPE	REQUIRED PRESERVATIVE	HOLDING TIME FROM DATE and TIME SAMPLED
SEMI-VOLATILE AND VOLATILE¹						
Volatile Organic Compounds	624 8260 SM6200	Water	3 x 40 mL	Vials	HCl to pH<2 Cool 4° C	14 Days
	8260	Soil	3 x 40 mL ²	Field Kit ²	Freeze at -10° C	Freeze 48 hours, Analysis 14 Days
	MAVPH	Water	3 x 40 mL	Vials	HCl to pH<2 Cool 4° C	14 Days
Methane, Ethane, Ethene	RSK147	Soil	2 x 40 mL ²	Field Kit ²	MeOH Cool to 4° C	28 Days
		Water	3 x 40 mL	Vials	HCl to pH<2 Cool 4° C	14 Days
Gasoline Range Organics (GRO)	8015	Water	3 x 40 mL	Vials	HCl to pH<2 Cool 4° C	14 Days
		Soil	2 x 40 mL	Vials	MeOH Cool to 4° C	14 Days
Diesel Range Organics (DRO)	8015	Water	2 x 250 mL ³	Amber Glass	H ₂ SO ₄ to pH<2 Cool 4° C	7 Days
		Soil	1 x 8 oz	Clear Glass	Cool, 4° C	14 Days
Acid Base Neutrals Extractable Organics	8270	Water	2 x 250 mL ³	Amber Glass	Cool, 4° C	7 Days
		Soil	1 x 8 oz	Clear Glass	Cool, 4° C	14 Days Analysis: 40 Days
Acid Base Neutrals Extractable Organics Organo Pesticides and PCBs by 608	608 625	Water	2 X 1 L	Amber Glass	Cool, 4° C	7 Days
Pesticides	8081	Water	2 x 250 mL ³	Amber Glass	Cool, 4° C	7 Days
		Soil	1 x 8 oz	Clear Glass	Cool, 4° C	14 Days Analysis: 40 Days
	8141	Water	2 x 250 mL ³	Amber Glass	Cool, 4° C	7 Days
PCBs	8082	Soil	1 x 8 oz	Clear Glass	Cool, 4° C	7 Days Analysis: 40 Days
		Water	2 x 250 mL ³	Amber Glass	Cool, 4° C	7 Days
Herbicides	8151	Water	2 x 250 mL ³	Amber Glass	Cool, 4° C	7 Days
		Soil	1 x 8 oz	Clear Glass	Cool, 4° C	14 Days
Explosives	8330A/B	Water	2 x 1 L	Amber Glass	Cool, 4° C	7 Days
	8330A	Soil	1 x 8 oz	Clear Glass	Cool, 4° C	14 Days Analysis: 40 Days
	8330B	Soil	Approximately 500 g	Clear Glass or Double Plastic Bags	Cool, 4° C	14 Days Analysis: 40 Days
EDB/DBCP	504.1 8011	Water	3 x 40 mL	Vials	Cool, 4° C 10 mg Na ₂ S ₂ O ₃ For Residual Cl ₂	14 Days
		Soil	1 x 8 oz	Clear Glass	Cool, 4° C	14 Days
Acrylamide	8316	Water	2 x 40 mL	Vials	Cool, 4° C	7 days
		Soil	1 x 4 oz	Clear Glass	Cool, 4° C	14 days
Perchlorate	6850	Water	1 x 125 mL	Plastic 2/3 Full	Cool, 4° C	28 days
		Soil	1 x 4 oz	Plastic 2/3 Full	Cool, 4° C	28 days
Extractable Petroleum Hydrocarbons (EPH)	MAEPH	Water	2 x 1 L	Amber Glass	H ₂ SO ₄ to pH<2 Cool 4° C	7 Days
		Soil	1 x 8 oz	Clear Glass	Cool, 4° C	Extraction: 14 Days Analysis: 40 Days
Total Recoverable Petroleum Hydrocarbons (TRPH)	FLPRO 8015	Water	2 x 250 mL ³	Amber Glass	H ₂ SO ₄ to pH<2 Cool 4° C	7 Days
		Soil	1 x 8 oz	Clear Glass	Cool, 4° C	Extraction: 14 Days Analysis: 40 Days
Perfluorinated Compounds	DoD 5.3 Table B-15	Water	2 x 125 mL	HDPP	Cool 4° C	Extraction: 28 Days Analysis: 40 Days
		Soil	1 x 4 oz			Extraction: 14 Days Analysis: 40 Days
	EPA 537 MOD	Water	2 x 125 mL			Extraction: 14 Days Analysis: 28 Days
Soil	1 x 4 oz					
TCLP AND SPLP						
TCLP/SPLP Extractables	8270 8081 8151		2 x 1 L	Amber Glass	Cool, 4° C	14 days for leaching, 7 days for extraction, 40 days for analysis
TCLP/SPLP Metals	6010		2 x 1 L	Amber Glass	Cool, 4° C	Extract. & Analysis: 6 Months Aqueous and Solid; Hg Extract. & Analysis: 28 Days Aqueous and Solid
TCLP/SPLP Volatiles	8260		2 x 40 mL	Vials	Cool, 4° C	Extract. & Analysis: 14 Days to leaching, 14 days to analysis
Full Water TCLP/SPLP		Water	5 x 1 L 1 x 1 L 2 x 40 mL	Amber Glass Plastic Glass Vials	Cool, 4° C	See Above for Individual Analyses
Full Soil TCLP/SPLP		Solid	2 x 8 oz + 1 x 4 oz	Glass Jars		
AIR						
Volatile Organics	TO3	Air	1 x 1 L	Tedlar Bag	None	72 Hours

INORGANIC ANALYSIS

IMMEDIATE TO 48 HOURS						
pH	SM4500-H; EPA 9040C	50 mL	Plastic, Glass	Cool, 4° C		15 minutes, Field Parameter
Biochemical Oxygen Demand	SM5210B	1 L	Plastic, Glass	Cool, 4° C		48 Hours
Color	SM2120B	100 mL	Plastic, Glass	Cool, 4° C		48 Hours
Ferrous Iron (Fe ⁺²)	SM 3500-Fe B	100 mL	Plastic	Cool, 4° C		15 minutes, Field Parameter
Hexavalent Chromium	EPA 7196A	500 mL	Plastic, Glass	Cool, 4° C		24 Hours
Nitrate Nitrogen	EPA 300/9056A	50 mL	Plastic, Glass	Cool, 4° C		48 Hours
Nitrite Nitrogen	EPA 300/9056A	100 mL	Plastic, Glass	Cool, 4° C		48 Hours
Nitrite Nitrogen	EPA 353.2	50 mL	Plastic, Glass	Cool, 4° C		48 Hours
Orthophosphate	EPA 365.3	100 mL	Plastic, Glass	Cool, 4° C		Field Filtered 15 minutes, 48 Hours
Sulfite	SM4500SO3	200 mL	Plastic, Glass	Cool, 4° C		15 minutes, Field Parameter
Total Residual Chlorine	SM4500CL-F	200 mL	Plastic, Glass	Cool, 4° C		15 minutes, Field Parameter
Total Settleable Solids	SM2540F	2 x 1 L	Plastic, Glass	Cool, 4° C		48 Hours
Turbidity	EPA180.1	100 mL	Plastic, Glass	Cool, 4° C		48 Hours
7 DAYS						
Sulfide	SM4500S=F	3 x 250 mL	Plastic, Glass	NaOH to pH>=9 ZnAc/Cool, 4° C		7 Days
Total Dissolved Solids (TDS)	SM2540C	1 L	Plastic, Glass	Cool, 4° C		7 Days
Total Mineral Solids	SM2540E/F	200 mL	Plastic, Glass	Cool, 4° C		7 Days
Total Solids (TS)	SM2540B	200 mL	Plastic, Glass	Cool, 4° C		7 Days
Total Suspended Solids (TSS)	SM2540D	1 L	Plastic, Glass	Cool, 4° C		7 Days
Total Volatile Solids (TVS)	SM2540E/F	200 mL	Plastic, Glass	Cool, 4° C		7 Days
Total Volatile Suspended Solids (TVSS)	SM2540E/F	200 mL	Plastic, Glass	Cool, 4° C		7 Days
GREATER THAN 7 DAYS						
Acidity/Alkalinity	SM 2310B	200 mL	Plastic, Glass	Cool, 4° C		14 Days
Amenable Cyanide	SW846 9012B	250 mL	Plastic, Glass	NaOH to pH>12/Cool, 4° C		14 Days
Ammonia Nitrogen	EPA 350.1	200 mL	Plastic, Glass	H ₂ SO ₄ to pH<2/Cool, 4° C		28 Days
Bromide	EPA 300/9056A	100 mL	Plastic, Glass	Cool, 4° C		28 Days
Bulk Density	ASTM D2937-94	8 OZ	Glass	Cool, 4° C		Not Regulated
Carbonate, Bicarbonate, CO ₂ calculation	SM2320B SM 4500-CO ₂	200 mL	Plastic, Glass	Cool, 4° C		14 Days
Chemical Oxygen Demand (COD)	SM5220C	100 mL	Plastic, Glass	H ₂ SO ₄ to pH<2/Cool, 4° C		28 Days
Chloride	EPA 300/9056A	100 mL	Plastic, Glass	Cool, 4° C		28 Days
Cyanide	EPA 335.4/9012B	250 mL	Plastic, Glass	NaOH to pH>12/Ascorbic Acid Cool, 4° C		14 Days
Fluoride	EPA 300/9056A	200 mL	Plastic	Cool, 4° C		28 Days
Hardness Calculation	SM 2340B	100 mL	Plastic, Glass	HNO ₃ to pH<2/Cool, 4° C		6 Months
Hexavalent Chromium	EPA 3060A/7196A	4 oz	Glass	Cool, 4° C		Digestion 30 days, Digestate 7 days
Ignitability	SW846 1010A	100 mL	Plastic, Glass	Cool, 4° C		Not Regulated
Mercury	EPA 245.1/7470A	500 mL	Plastic, Glass	HNO ₃ to pH<2/Cool, 4° C		28 Days
Nitrate + Nitrite Nitrogen	EPA 353.2	100 mL	Plastic, Glass	H ₂ SO ₄ to pH<2/Cool, 4° C		28 Days
Nitrate Nitrogen	EPA 353.2	50 mL	Plastic, Glass	H ₂ SO ₄ to pH<2/Cool, 4° C		28 Days
Oil & Grease	EPA 1664A/B/9070A	2 x 1 L	Glass	H ₂ SO ₄ to pH<2/Cool, 4° C		28 Days
Organic Nitrogen	TKN - AMN	500 mL	Plastic, Glass	H ₂ SO ₄ to pH<2/Cool, 4° C		28 Days
Oxidation Reduction Potential	ASTM D1498-76	200 mL	Plastic, Glass	Cool, 4° C		Not Regulated
Paint Filter Test	EPA 9065	200 mL	Plastic, Glass	Cool, 4° C		Not Regulated
Percent Ash	ASTM D482-91/D2974-00	100 mL	Plastic, Glass	Cool, 4° C		Not Regulated
Phenols	EPA 420.4	250 mL	Glass	H ₂ SO ₄ to pH<2/Cool, 4° C		28 Days
Reactive Cyanide	SW846 Chapter 7	100 mL	Plastic, Glass	Cool, 4° C		Not Regulated
Reactive Sulfide	SW846 Chapter 7	100 mL	Plastic, Glass	Cool, 4° C		Not Regulated
Specific Conductance	EPA 120.1	200 mL	Plastic, Glass	Cool, 4° C		28 Days
Sulfate	EPA 300/9056A	200 mL	Plastic, Glass	Cool, 4° C		28 Days
Total Kjeldahl Nitrogen (TKN)	EPA 351.2	100 mL	Plastic, Glass	H ₂ SO ₄ to pH<2/Cool, 4° C		28 Days
Total Metals	EPA 6010/6020/200.7/200.8	500 mL	Plastic, Glass	HNO ₃ to pH<2/Cool, 4° C		6 Months
Total Nitrogen	TKN + NO ₂ + NO ₃	500 mL	Plastic, Glass	H ₂ SO ₄ to pH<2/Cool, 4° C		28 Days
Total Phosphorus	EPA 365.3	200 mL	Plastic, Glass	H ₂ SO ₄ to pH<2/Cool, 4° C		28 Days
Total, Dissolved Organic Carbon	SM5310B/9060A	2 x 40 mL	Amber VOC Vials	HCl to pH<2/Cool, 4° C		28 Days

Solids and soils may be analyzed for the above analytes with a general requirement of approximately 100 grams (60 ml) per analyte, or in combinations of analytes in 1-300 ml bottle.

¹ Multiple analyses can be performed from a single container, please contact SGS Orlando for guidance.

² Pre-weighed methanol preserved and/or DI water vials are available upon request (Method 5035 preservation) for volatile analysis.

³ For South Carolina EPA 8000 Series, use 2 x 1 L Amber Glass Bottles preserved as noted.



SAMPLE AND LABORATORY WASTE DISPOSAL

Prepared by: Jonathan Miller Date: 08/21/2020

Approved by: Svetlana Izosimova Date: 08/24/2020

Annual Review

Reviewed by: _____ Date: _____

Reviewed by: _____ Date: _____

Reviewed by: _____ Date: _____

Document Control

Issued to: QA Department Date: 08/24/2020

Issued to: Sample Management (Shipping) - digital Date: * 08/25/2020

Issued to: _____ Date: _____

Issued to: _____ Date: _____

Issued to: _____ Date: _____

Issued to: _____ Date: _____

Effective 7 days after "*" date

**CONTROLLED COPY
DO NOT DUPLICATE**

TITLE: SAMPLE AND LABORATORY WASTE DISPOSAL

REFERENCES: Florida DEP Hazardous Waste; 40 CFR, Part 261

REVISED SECTIONS: Multiple rewrites in Procedure – sec. 4.1, 4.2, 4.3; 4.5.2, Segregation of Foreign soils – see 4.2.5; Storage and Disposal of samples in “HOLD” status – sec. 4.7 (new), corrected facility name throughout the document; changed lab status to Large Quantity Generator, added detailed waste profiles to the back of the document.

1.0 SCOPE AND APPLICATION

The disposal of samples and lab waste adhering to Florida State and Federal Regulations.

2.0 SUMMARY

This SOP describes the procedures used by SGS - Orlando to properly and safely dispose of samples and laboratory wastes; hazardous and non-hazardous; domestic and foreign.

3.0 DEFINITIONS

- 3.1 Foreign sample: Samples from sites that are outside the continental United States.
- 3.2 Hazardous Sample or Waste: A material is considered hazardous if it is listed in the Code of Federal Regulations, 40 CFR, Part 261 or it demonstrates any of the hazardous characteristics including, ignitability, corrosivity, reactivity, or has demonstrated toxicity.

4.0 PROCEDURE

Sample Disposal: Samples are kept in appropriate storage for a minimum of 30 days after the report is sent to the client unless otherwise specified by client. The samples are divided into three categories: Aqueous, Soil, and Non-aqueous liquid.

- 4.1 Aqueous Samples
 - 4.1.1 A disposal list is generated based on either reporting dates or sample number range (see attached).
 - 4.1.2 Samples are then removed from the refrigerators and/or cabinets, and are separated as non-hazardous (non-detected or normal) and hazardous samples.
 - 4.1.3 Non-hazardous samples are emptied into a drum. Once a series of satellite drums are full, they are pumped into a 500 gallon holding tank. Once the large holding tank is full, the tank is neutralized with sodium bicarbonate to pH 5-9. The

**CONTROLLED COPY
DO NOT DUPLICATE**

contracted waste disposal company is then contacted to arrange for an on-site transfer. The contents are profiled as requested by the disposal firm unless a major change to the waste stream occurs.

- 4.1.4 VOA vials are processed through a glass crusher and into an open-top drum. The solid material (glass, plastic, and septa) is separated from the liquid and are disposed of separately. The liquid drum, when full, is then handled in the same way as described in section 4.1.3.
 - 4.1.5 Hazardous waste is segregated into into multiple waste streams to be handled in the appropriate manner by the Contract Disposal Company used by SGS-Orlando.
 - 4.1.6 Samples containing PCB in excess of 50 ppm are automatically flagged by LIMS on disposal list. These samples are labeled with distinct PCB label and segregated from the rest of waste samples to be disposed of in LabPak.
 - 4.1.7 Some samples, on a case by case basis, are returned to the client for disposal.
- 4.2 Soil Samples
- 4.2.1 Domestic Soil Samples (DSS) are placed in drums after the storage period, either in a hazardous or non-hazardous drum per the samples' status as defined above.
 - 4.2.2 When the drums are full, they are labeled accordingly, and the vendor contacted for removal.
 - 4.2.3 Some samples, on a case by case basis, will be returned to the client for disposal, or may need specialized disposal such as LabPak. This would include samples of a proprietary nature, or those that contain excessive amounts of regulated or unregulated materials. (ie: Very high PFC content, PCBs in excess of 50ppm, elemental samples, etc.)
 - 4.2.4 Foreign soil samples (FSS) come in vials (volatile organic analysis) or jars. These soils are segregated in in lockable cage (see also SAM101 and SAM109, current revisions)
 - 4.2.5 After minimum 60-day hold period, but not to exceed 6 months, these FSS are disposed of in the following manner.
 - 4.2.5.1 FSS vials: Vial samples are preserved either with methanol or DI water. Vials with water are uncapped and placed into a drum labeled specifically for foreign soils. No more than six months may elapse form the accumulation start date on the drum before the drum must be disposed. The contracted disposal company must be certified to handle and dispose of foreign soils. Vials with methanol must be filtered. The filtrate (methanol) is disposed of in the non-chlorinated solvent waste drum. The soil is then drummed per the hazard status on the disposal sheets.

4.2.5.2 FSS Solids: FSS in jars are emptied into drum labeled specifically for foreign soils. Once full, the drum is disposed of via the contracted disposal company. No more than six months may elapse from the accumulation start date on the drum to disposal.

4.3 Non-aqueous liquid samples

4.3.1 Non-aqueous samples are placed in drums after the hold period.

4.3.2 When the drums are full, they are labeled accordingly, and the vendor contacted for removal. Drums have a 6 month expiration time. If the drum is not full by then it is picked up by our contract disposal company.

4.3.3 Samples may, on a case by case basis, will be returned to the client for disposal.

4.4 Sample Containers

4.4.1 Containers from samples deemed Non-Hazardous are immediately disposed of into a waste container provided by waste management services specifically for SGS - Orlando direct use. A lock and key has been installed to keep the containers use limited to SGS - Orlando only.

4.4.2 Containers from samples deemed hazardous are disposed of into the Hazardous waste solids drum or other appropriate waste stream.

4.4.3 The contracted vendor picks the container up on a weekly basis and brings to the local sort facility where contents are destroyed - recycled.

4.5 Laboratory Waste Disposal:

4.5.1 All materials determined to be hazardous are containerized in appropriate vessels (i.e. drums). A waste is considered hazardous if it is listed in the Code of Federal Regulations, 40 CFR, Part 261 or it demonstrates any of the hazardous characteristics including, ignitability, corrosivity, reactivity, or has demonstrated toxicity. Our contract disposal company disposes of the drums.

4.5.2 WASTE DRUMS are separated by type. As of the date of this SOP, SGS-Orlando is separating wastes into several different waste streams. General descriptions of the primary stream types are below. A more descriptive list along with the corresponding profile numbers and primary generators within the labs can be found at the end of this document. If/when new profiles are needed, the contract vendor must be contacted and the appropriate information supplied.

Chlorinated Waste- Methylene Chloride

Non-Chlorinated Waste - Hexane, Methanol, and mixed solvents

Sodium Sulfate/Used Charcoal- Charcoal and paper filters used in the filtering of samples.

Non Hazardous Aqueous Vials - Primarily Acid Vials.

Hazardous Flammable Vials - Methylene Chloride, Hexane.

Hazardous Aqueous waste - High Odor Samples, Lachat Waste.

Non Hazardous Soil - Soils.

Hazardous Solid Waste - .

Non-Aqueous/Oil Samples-

Drums are closed at all times while in storage.

4.5.3 Disposal is done as conscientiously as possible following guidelines set forth by both the State of Florida and our contract disposal company. Management and proper handling is necessary to avoid any violation. The guidelines change depending on how much waste is generated on a monthly basis:

4.5.3.1 Less than 220 pounds (100 kilograms or about half a drum) is a "Conditionally Exempt Small Quantity Generator".

4.5.3.2 A "Small Quantity Generator" generates 220-2,200 pounds (100-1,000 kilograms or about half a drum to 5 drums)

4.5.3.3 More than 2,200 pounds (100-1,000 kilograms or more than about 5 drums) is a "Large quantity Generator".

4.5.3.4 SGS - Orlando is considered a "Large Quantity Generator".

4.6 Waste Containers and Storage

4.6.1 Containers must be maintained in good condition at all times. Care must be taken to prevent leaks, ruptures, and the accumulation of rainwater on tops of the drums.

4.6.2 Waste containers must be kept closed at all times, except when waste is being transferred to drum.

4.6.3 The containers must be compatible with the waste being stored (i.e. acids should not be stored in metal drums). Never store incompatible wastes in the same container (i.e. acids and bases). Containers must be stored in such a way to accommodate inspection for leaks and damage from all sides

4.6.4 Each waste container must be labeled with the following information.

4.6.4.1 Type and nature of waste (soil, oil, hazardous, non-hazardous)

- 4.6.4.2 Waste generator's name and address
 - 4.6.4.3 Manifest document number
 - 4.6.4.4 Proper DOT shipping name and identification number
 - 4.6.4.5 Accumulation start date (change to storage date when container is full)
 - 4.6.4.6 In addition, a hazardous waste must have the words "HAZARDOUS WASTE. FEDERAL LAW PROHIBITS IMPROPER DISPOSAL. IF FOUND, PLEASE CONTACT THE NEAREST POLICE OR PUBLIC SAFETY AUTHORITY OR THE U.S. ENVIRONMENTAL PROTECTION AGENCY" prominently displayed on the container.
- 4.6.5 Inspection and Records
- 4.6.5.1 Containers must be inspected weekly. All records must be kept on file for three years. The records, which must be kept on file, include:
 - 4.6.5.1.1 A written log of the inspections
 - 4.6.5.1.2 Manifests and shipping receipts
 - 4.6.5.1.3 Land Disposal Restriction form
- 4.7 Samples in "HOLD" status
- 4.7.1 Wherever samples are designated to be put on hold by the client, labels on these samples are highlighted in bright pink and additional bright pink "**HOLD – Do Not Dispose**" label is attached to the individual containers.
 - 4.7.2 Additionally, all Foreign Soils are kept in lockable cage in regardless of status (see 4.2.6).
 - 4.7.3 When samples are removed from the temperature controlled storage and boxed for extended storage these boxes also receive same bright pink label as individual containers.
 - 4.7.4 Samples are segregated into a designated quarantine area with clear signs to the nature of the stored samples.
 - 4.7.5 Prior to removal and disposal from this area, personnel must first confirm with management (Sample Management Supervisor, Laboratory Manager or Operations Manager) that samples can indeed be disposed of.
 - 4.7.5.1 Due to 6-months storage restriction on Foreign soils samples (see 4.2.7.1) Project Manager's input must be requested by Sample Management department in a timely manner.

5.0 HEALTH AND SAFETY

- 5.1 All employees who handle waste materials should wear full protective clothing including safety glasses &/or face shield, gloves, boots, lab coat or a Tyvek suit, and air-purifying respirator. Direct skin contact with waste materials should be avoided.
- 5.2 If an employee has accidentally been exposed to a hazardous waste, the individual should rinse the affected areas thoroughly under a safety shower for at least 15 minutes. If the individual begins to exhibit any adverse effects from the exposure, he should be immediately transported to the nearest hospital emergency room. Employees are referred to the Material Safety Data Sheets for specific instructions on exposure to hazardous substances.

WASTE PROFILES			
NAME (Dept.)	DESCRIPTION	PROFILE NUMBER	Primary Constituents
Recovered Methylene Chloride/Chlorinated Solvents (EXT)	Waste Methylene Chloride (aka: Dichloromethane, DCM, CH ₂ Cl ₂ , Me-Cl) generated through extraction and analysis process. May be from Bucchi units and or wastes, or rinse products from Extractions or Semi-Volatiles labs. This waste stream should contain <1.0% material that is NOT Me-Cl.	D191839TPA	Should be >99% Me-Cl.
Solvent Contaminated Vials (SEMIS)	Glass Prep or Autosampler vials that may have residual solvent and/or sample in them. Solvents may be chlorinated or non-chlorinated in nature. Can be for Aq or solid samples.	D191838TPA	Could contain Acetone, Hexane, Acetonitrile, Me-Cl, Me-OH, Ether, etc.
Methanol Contaminated Plastic Vials (LCMS)	Plastic Prep or Autosampler vials that may have residual solvent and/or sample in them. Solvents may be chlorinated or non-chlorinated in nature. Can be for Aq or solid samples. Waste stream is primarily comprised of Sample vials used for LCMS prep and analysis.	F191708TPA	Waste contains mainly a mixture of Me-OH, water and spent samples.
Non-Chlorinated Solvent (EXT SEMIS LCMS)	Waste Solvent that is non-chlorinated. The bulk of this waste stream is generated as eluent for LCMS, but it can also include the flammable wastes generated in Semis and Extractions as well. FLAMMABLES.	D190752TPA	Typically >90% Me-OH, but can also contain up to 5% of other non-chlorinated solvents such as Acetone, Acetonitrile, Hexane, Ether, etc.
Sodium Sulphate contaminated with Methylene Chloride (EXT)	This is the product of the drying step in Extractions. It consists primarily of Na ₂ SO ₄ solids along with the accompanying filter paper and waste sample dregs that have been rinsed with Me-Cl. Waste stream is typically gathered in small 2gal pails with liners inside them. The liners and waste are collected, and the pails are then reused with fresh liners.	D191841TPA	Waste is comprised almost entirely of sodium sulphate. No other solvents should be in this stream except Me-Cl.
Mixed inorganic Acids (MET GEN)	Mixed inorganic acids (HCl, HNO ₃ , H ₂ SO ₄ , H ₃ PO ₄ , etc.) that have been primarily used in the Inorganics department for digestion and or sample dissolution. Waste is typically more concentrated than preserved samples, and is not neutralized before disposal.	F190687TPA	Metals digests and ICP waste.
Non-Regulated Soil (Non-APHIS)	All spent soil samples that are not foreign in nature.	ACCL 003	Samples. Soils samples.
3-Door Waste Samples	Samples from 3-Door storage. Samples mainly comprised of contaminated solids that have petroleum type products on them such as spill pads, soaked rags, wipes, filters, soils and papers in plastic bags/containers. The samples may/will have free liquids that may be petroleum in nature.	J191619TPA	Samples. 3-Door Material. Solids and liquids.
APHIS Soils	Foreign Soils. Spent samples and lab items that have come into contact with foreign soils during the process of analysis. All items are sequestered from other waste streams!	ACCL 004	Expired 10-24-19
Broken Glass	Labware that has broken during standard usage and/or disposable glassware within the laboratories. May include pipets, beakers, jars, etc.	ACCL 002	Broken glass from labs. Beakers, cylinders, glass jars, etc.
Used Oil	Spent oil from the labs. Oils used for production purposes (pumps and standards), as well as spent samples and their associated wastes that are oil based.	J190773TPA	Samples. Used Oils. Samples and lab oils used in pumps, for stds, etc.
Used Photo Developer Solution	Spent photo development solutions. Typically containing very high amounts of heavy metals (Ag) and basic (pH>10) in nature. Separated from all other metals waste streams.	J191664TPA	Samples. Spent photo development solutions. Typically from samples.
Pyridine	Waste Pyridine solvent. Diluted with H ₂ O. Waste is generated in Inorganics department via the Lachat instrumentation.	ACCL 007	Pyridine and H ₂ O

**CONTROLLED COPY
DO NOT DUPLICATE**

ATTACHMENT B

Field Documentation Forms

1. Example Field Daily Logbook
2. Water Level Field Data Worksheet
3. Passive Diffusion Bag (PDB) Groundwater Sampling Form
4. Groundwater Sampling and Pressure Levels Form for Westbay Wells
5. Water Level Indicator Calibration by Steel Tape
6. Ahtna Daily Site Safety Tailgate / Inspection Log
7. Fort Ord Munitions and Explosives of Concern (MEC) Incident Reporting Form
8. Ahtna Chain of Custody (Water / Soil)
9. Example Sample Labels
10. Post-Treatment Parameter Monitoring Form

Former Ft. Ord, CA

3/1/2020

1Q2020 Groundwater Monitoring
Project #Weather: (am) Clear, cool 48°
(pm) Overcast, 63°

Team #2

Ahtna Rep. - Shaelyn Hession
Blaine Tech Rep. - Ross Mikovich

0900- Arrived at MW-002-18-A

W.L. = 78.40 T.D. = 110.6

0810- Sample collected from station #2
#2010Y0U2100F

0815- Duplicate sample #2010Y0U2101D

0820- Labeled Trip Blank #2010Y0U2102A

Lid requires new paint & I.D.

0835- Arrived at MW-BW-75-A

W.L. = 84.32 T.D. = 126.3

Required new lock - replaced.

0845- Arrived at MW-BW-14-A

W.L. = 63.11 T.D. = 97.5

3/1/2020

1Q2020 FO GWM

Team #2

S. Hession

R. Mikovich

0900- Arrived at MW-BW-07-180

W.L. = 121.63 T.D. = 194.6

0910- Sample collected from station #1
#2010Y0BW103F

0915- Station #2 sample #2010Y0BW104F

0920- Station #3 sample #2010Y0BW105F

0925- Station #4 sample #2010Y0BW106F

0930- Station #5 sample #2010Y0BW107F

No PDB's installed.

1000- Return to staging area.

Unload equipment

QC all samples, placed in refrigerator.

1030- Team #2 offsite

~~Steve Holby~~

**Groundwater Sampling
and Pressure Levels Form
for Westbay Wells**



Project Number: _____

Well Name: MP - BW -

Client: USACE

Task Manager: _____

Sample Date: / /

Location: Former Fort Ord

Technicians: _____

Barometric Pressure: _____

Probe Type: West Bay

Recorded By: _____ / _____
(Signature) (Initials)

Sample Time: Start: _____
Finish: _____

DTW: _____

Reviewed By: _____ / _____
(Signature) (Initials)

Sample # First Port: _____

Probe Serial No.: _____

Port Identification			Surface Functioning Tests (Probe in Flushing Collar)						Position Sampler	Pressure Test and Sample Collection Check at Port											
Port No.	Port Name	Port Depth (Cable)	Arm Out Land Probe Shoe Out	Close Valve	Check Vacuum	Open Valve	Evacuate Container	Close Valve Shoe In	1. Locate Port 2. Arm Out 3. Land Probe	Pressure Test (Pressure Test)					Sample Collection (Sample Collection)					Last 4 Digits of Sample #	
										Pressure in MP (Internal)	Shoe Out	Zone Pressure (External)	Open Valve	Zone Pressure (External)	Close Valve	Shoe In	Pressure in MP (Internal)				
			<input type="checkbox"/>	<input type="checkbox"/>	<input type="checkbox"/>	<input type="checkbox"/>	<input type="checkbox"/>	<input type="checkbox"/>	<input type="checkbox"/>		<input type="checkbox"/>		<input type="checkbox"/>		<input type="checkbox"/>		<input type="checkbox"/>		<input type="checkbox"/>		
			<input type="checkbox"/>	<input type="checkbox"/>	<input type="checkbox"/>	<input type="checkbox"/>	<input type="checkbox"/>	<input type="checkbox"/>	<input type="checkbox"/>		<input type="checkbox"/>		<input type="checkbox"/>		<input type="checkbox"/>		<input type="checkbox"/>		<input type="checkbox"/>		
			<input type="checkbox"/>	<input type="checkbox"/>	<input type="checkbox"/>	<input type="checkbox"/>	<input type="checkbox"/>	<input type="checkbox"/>	<input type="checkbox"/>		<input type="checkbox"/>		<input type="checkbox"/>		<input type="checkbox"/>		<input type="checkbox"/>		<input type="checkbox"/>		
			<input type="checkbox"/>	<input type="checkbox"/>	<input type="checkbox"/>	<input type="checkbox"/>	<input type="checkbox"/>	<input type="checkbox"/>	<input type="checkbox"/>		<input type="checkbox"/>		<input type="checkbox"/>		<input type="checkbox"/>		<input type="checkbox"/>		<input type="checkbox"/>		
			<input type="checkbox"/>	<input type="checkbox"/>	<input type="checkbox"/>	<input type="checkbox"/>	<input type="checkbox"/>	<input type="checkbox"/>	<input type="checkbox"/>		<input type="checkbox"/>		<input type="checkbox"/>		<input type="checkbox"/>		<input type="checkbox"/>		<input type="checkbox"/>		
			<input type="checkbox"/>	<input type="checkbox"/>	<input type="checkbox"/>	<input type="checkbox"/>	<input type="checkbox"/>	<input type="checkbox"/>	<input type="checkbox"/>		<input type="checkbox"/>		<input type="checkbox"/>		<input type="checkbox"/>		<input type="checkbox"/>		<input type="checkbox"/>		
			<input type="checkbox"/>	<input type="checkbox"/>	<input type="checkbox"/>	<input type="checkbox"/>	<input type="checkbox"/>	<input type="checkbox"/>	<input type="checkbox"/>		<input type="checkbox"/>		<input type="checkbox"/>		<input type="checkbox"/>		<input type="checkbox"/>		<input type="checkbox"/>		
			<input type="checkbox"/>	<input type="checkbox"/>	<input type="checkbox"/>	<input type="checkbox"/>	<input type="checkbox"/>	<input type="checkbox"/>	<input type="checkbox"/>		<input type="checkbox"/>		<input type="checkbox"/>		<input type="checkbox"/>		<input type="checkbox"/>		<input type="checkbox"/>		

General Comments: _____ Cooler Temp: _____ °C
 QC Sample # _____ Associated Sample: _____

Fort Ord Groundwater Monitoring Program
Water Level Indicator Calibration by Steel Tape

Event:	
Well #:	
Steel Tape DTW:	
Date:	

Serial #	Measured DTW	Calibration Correction

Reviewed By:	
Date:	

AHTNA DAILY SITE SAFETY TAILGATE / INSPECTION LOG

GENERAL DATA
Date:

Site:

Site Location:

AHTNA Site CDSO/DR:

AHTNA SSHO:

DOCUMENTATION OF WORKDAY SAFETY MEETING (List Topics of Discussion):

 Other items to address as appropriate (**check those discussed**):

<input type="checkbox"/> Scope of day's work <input type="checkbox"/> Site SH&E Plan / Revisions <input type="checkbox"/> AHA's / PTSP's completed/reviewed? <input type="checkbox"/> Emergency SOPs (i.e., rally pt., tele #s) <input type="checkbox"/> Communications Check <input type="checkbox"/> PPE Requirements	<input type="checkbox"/> OSHA's Focus Four <input type="checkbox"/> Fall Hazards <input type="checkbox"/> Electrical Hazards <input type="checkbox"/> Struck-by Hazards <input type="checkbox"/> Caught in / between Hazards <input type="checkbox"/> Other Primary Hazards	<input type="checkbox"/> Recent near miss / injuries / lessons <input type="checkbox"/> Lifting Safety / Materials Handling <input type="checkbox"/> BBS Hazard Triggers ⁱ <input type="checkbox"/> BBS Trigger Controls ⁱⁱ <input type="checkbox"/> Other (heat, noise, trench, confine sp)
---	--	--

MEETING ATTENDEES: (place * next to subcontractor safety representatives)

NAME / COMPANY	NAME / COMPANY

DAILY INSPECTIONS: (SSHO shall initial each completed applicable inspection item)

Y	N	N	Inspection Item	Y	N	N	Inspection Item	Y	N	N	INSPECTION ITEM OTHER (List)
		A				A				A	
<input type="checkbox"/>	<input type="checkbox"/>	<input type="checkbox"/>	Postings/Plans (APP) readily avail.	<input type="checkbox"/>	<input type="checkbox"/>	<input type="checkbox"/>	Signs (No Smoking, Site Control)	<input type="checkbox"/>	<input type="checkbox"/>	<input type="checkbox"/>	
<input type="checkbox"/>	<input type="checkbox"/>	<input type="checkbox"/>	Designated Parking / Traffic Control	<input type="checkbox"/>	<input type="checkbox"/>	<input type="checkbox"/>	PPE(head/eye/foot/hand/ear/body)	<input type="checkbox"/>	<input type="checkbox"/>	<input type="checkbox"/>	
<input type="checkbox"/>	<input type="checkbox"/>	<input type="checkbox"/>	Subcontractor Safety Rep Involved	<input type="checkbox"/>	<input type="checkbox"/>	<input type="checkbox"/>	Hi-Vis, PFD's, Ring Buoys, Etc.	<input type="checkbox"/>	<input type="checkbox"/>	<input type="checkbox"/>	
<input type="checkbox"/>	<input type="checkbox"/>	<input type="checkbox"/>	Subcontractor / Task AHA's	<input type="checkbox"/>	<input type="checkbox"/>	<input type="checkbox"/>	Excav./Trench/Spoils Protection	<input type="checkbox"/>	<input type="checkbox"/>	<input type="checkbox"/>	
<input type="checkbox"/>	<input type="checkbox"/>	<input type="checkbox"/>	Subcontractor Equip. Inspections	<input type="checkbox"/>	<input type="checkbox"/>	<input type="checkbox"/>	Confined Spaces Management	<input type="checkbox"/>	<input type="checkbox"/>	<input type="checkbox"/>	
<input type="checkbox"/>	<input type="checkbox"/>	<input type="checkbox"/>	Emergency Equip. (PFE's, FA Kits)	<input type="checkbox"/>	<input type="checkbox"/>	<input type="checkbox"/>	Physical Barriers / Covers	<input type="checkbox"/>	<input type="checkbox"/>	<input type="checkbox"/>	
<input type="checkbox"/>	<input type="checkbox"/>	<input type="checkbox"/>	Eye Wash / Shower	<input type="checkbox"/>	<input type="checkbox"/>	<input type="checkbox"/>	Fall Hazards (Protected)	<input type="checkbox"/>	<input type="checkbox"/>	<input type="checkbox"/>	
<input type="checkbox"/>	<input type="checkbox"/>	<input type="checkbox"/>	Communications Check	<input type="checkbox"/>	<input type="checkbox"/>	<input type="checkbox"/>	Ladders	ISSUES TO FOLLOW-UP (Immediately Correct Deficiencies if able)			
<input type="checkbox"/>	<input type="checkbox"/>	<input type="checkbox"/>	Sanitation (Toilets, Hand Wash)	<input type="checkbox"/>	<input type="checkbox"/>	<input type="checkbox"/>	Power & Portable Hand Tools				
<input type="checkbox"/>	<input type="checkbox"/>	<input type="checkbox"/>	Water & Shade, Non-Pot Identified	<input type="checkbox"/>	<input type="checkbox"/>	<input type="checkbox"/>	Company Field Equipment				
<input type="checkbox"/>	<input type="checkbox"/>	<input type="checkbox"/>	Utilities Identified / Controlled	<input type="checkbox"/>	<input type="checkbox"/>	<input type="checkbox"/>	Alarms / Seatbelts				
<input type="checkbox"/>	<input type="checkbox"/>	<input type="checkbox"/>	Material Storage Proper	<input type="checkbox"/>	<input type="checkbox"/>	<input type="checkbox"/>	GFCI's, Whip-Checks, Slings				
<input type="checkbox"/>	<input type="checkbox"/>	<input type="checkbox"/>	Lay Down Areas Orderly	<input type="checkbox"/>	<input type="checkbox"/>	<input type="checkbox"/>	Exposed Rebar Protected				
<input type="checkbox"/>	<input type="checkbox"/>	<input type="checkbox"/>	Waste Containers	<input type="checkbox"/>	<input type="checkbox"/>	<input type="checkbox"/>	Safety / Health Behaviors:				
<input type="checkbox"/>	<input type="checkbox"/>	<input type="checkbox"/>	Spill Control (Pads, Snakes, Drums)	<input type="checkbox"/>	<input type="checkbox"/>	<input type="checkbox"/>	Competent / Qualified Persons				

Immediately correct any deficiencies. Note any uncorrected deficiencies on the APP Safety and Occupational Health Deficiency Tracking Log.
Comments/Field Notes:
I acknowledge that above elements were inspected and discussed

SSHO/CDSO/DR (signature):

Date:



AHTNA DAILY SITE SAFETY TAILGATE / INSPECTION LOG

Additional MEETING ATTENDEES: (place * next to subcontractor safety representatives)

NAME / COMPANY		NAME / COMPANY

SUBCONTRACTOR SAFETY REPs COMMENTS?

NOTES / COMMENTS / SKETCHES

ⁱ **BBS Triggers:** (e.g. Distractions, rushing, short-cuts, frustration, exhaustion, complacency, anger, multi-tasking, mind elsewhere)

ⁱⁱ **BBS Trigger Controls:** (e.g. communicating, accountability, patience, relaxation techniques, healthy lifestyle, and adequate sleep).

FORT ORD MUNITIONS AND EXPLOSIVES OF CONCERN (MEC) INCIDENT REPORTING FORM

If you recognize any object that resembles munitions or explosives on current or former Fort Ord property, retreat to a safe location, and report the finding to the **appropriate agencies immediately** (see below)

A. PROVIDE THE FOLLOWING INFORMATION:

Name of Person Reporting:	Telephone:
Agency:	Fax:
Date & Time of Incident/Discovery:	
Description of Item Found (refer to the "Safety Alert" pamphlet if possible):	
Location (direction from nearest road/building, attach map if possible):	
GPS Coordinate Location: (Type of Instrument, NAD83 California State Plan Coordinates Zone IV, feet)	
Describe how the item was found:	

CONTACT THE APPROPRIATE AGENCIES IMMEDIATELY:

Initial when completed	Mon– Thu (6 a.m. – 5 p.m.) Contact and FAX Form to:	Contact Number	Date & Time Called
	USACE Ordnance Safety Specialist or MMRP Site Safety Manager	Ph: (831) 884-9925 ext.226 Cell: (831) 760-2571 Fax:(831) 884-9030 Ph: (831) 242-7919 Fax:(831) 242-7019 Cell: (831) 760-2575	
	Fri – Sun (24 Hours) 60 th Civ Engr Sqdn EOD	Phone: (707) 424-5517	
	Note: If 60 th Civ Engr Sqdn EOD is contacted, notify the MMRP Site Safety Manager: (831) 242-7919, Cell (831) 760-2575.		

B. To be completed by USACE Ordnance Safety Specialist when applicable (Mon – Thu)

Form Received By:	Date & Time:
Identification of Item Found:	
Extent of Area Surveyed:	Name of digital file for picture (date):
Disposition of Item:	
Fax completed form to MMRP Site Safety Mgr Bldg 4463 Gigling Rd, POM (Fort Ord) when response complete	Fax: (831) 242-7091 Phone: (831) 242-7919
Date & Time:	

C. To be completed by MMRP Site Safety Manager:

Acknowledge Completed Form Received:	Date & Time:
Regulatory Agencies Notified (Date):	

ATTACHMENT C

Three Phase Quality Control Process and Documentation

**INVESTIGATION, MONITORING, O&M PROJECTS
PREPARATORY PHASE INSPECTION COVER SHEET**

Contract No.: _____

Date: _____

Task No.: _____

Location/Project: _____

A. Key Personnel Present:

	<u>Name</u>	<u>Position</u>	<u>Company</u>
1.	_____	_____	_____
2.	_____	_____	_____
3.	_____	_____	_____
4.	_____	_____	_____
5.	_____	_____	_____
6.	_____	_____	_____
7.	_____	_____	_____
8.	_____	_____	_____
9.	_____	_____	_____
10.	_____	_____	_____

B. Submittals:

1. Review submittals and/or submittal register. Have all applicable submittals been approved?

Yes___ No___

If No, what items have not been submitted?

- a. _____
- b. _____
- c. _____

USACE Representative Signature

Quality Control Manager Signature

INVESTIGATION, MONITORING, O&M PROJECTS: PREPARATORY PHASE INSPECTION CHECKLIST

Assessment Activity	Assessment Mechanism	Person(s) Responsible	Response Action	Completed by/Date
Have planning documents been prepared in accordance with the statement of work, regulatory requirements, and contract requirements?	Quality control review of document by Project Manager and QC reviewer.	Project Manager, QC Reviewer	Modify document as directed by reviewers	
Prior to project activities: Have planning documents been read by appropriate project personnel (including subcontractors) before work is conducted.	Documentation (e.g., sign-off form, note to file, email acknowledgement) that document has been read and requirements are understood.	Subcontractors as required. Project Manager, Task Manager, and Project Chemist to check signoff and forms.	Direct project personnel to read relevant documents.	
Prior to project activities: Has required preliminary work (e.g., clearance activities, permits, site access) been completed in accordance with project plan.	Comparison of information obtained from preliminary work completion assessment as specified in the project planning document(s).	Project Manager, Safety and Health Officer, QC Manger/Reviewer, Task Manager, Project Chemist, Field Staff	Delay startup if necessary preliminary work has not been completed. Implement corrective actions by directing appropriate personnel or subcontractors to complete necessary preliminary work.	
Prior to project activities: Are staff and subcontractors prepared to implement project activities according to planning documents?	Review and discussion of planned activities prior to implementation.	Project Manager, Safety and Health Officer, Quality Control System Manager, Task Manager, Project Chemist, Field staff.	Delay startup if staff and subcontractors are not prepared to implement activities <i>in</i> accordance with specification.	
Prior to project activities: Is necessary field equipment available and in acceptable working order?	Compare field equipment list with planned activities. Compare field equipment calibration documentation with project goals specified in the SAP.	Project Manager, Quality Control System Manager, Task Manager, Project Chemist, Field staff.	Delay startup if equipment is unavailable or not in proper working order. Implement corrective actions to include use of alternate equipment, or recalibration of available equipment.	

**INVESTIGATION, MONITORING, O&M PROJECTS
INITIAL PHASE INSPECTION COVER SHEET**

Contract No.: _____

Date: _____

Task No.: _____

Location/Project: _____

Description and Location of Work Inspected: _____

A. Key Personnel Present:

	<u>Name</u>	<u>Position</u>	<u>Company</u>
1.	_____	_____	_____
2.	_____	_____	_____
3.	_____	_____	_____
4.	_____	_____	_____
5.	_____	_____	_____
6.	_____	_____	_____
7.	_____	_____	_____
8.	_____	_____	_____
9.	_____	_____	_____
10.	_____	_____	_____

Quality Control Manager Signature

INVESTIGATION, MONITORING, O&M PROJECTS: INITIAL PHASE INSPECTION CHECKLIST

Assessment Activity	Assessment Mechanism	Person(s) Responsible	Response Action	Completed by/Date
Beginning of project activity: Is work being performed according to project plans?	Conduct field and laboratory audits.	Project Manager, Quality Control System Manager, Task Manager, Project Chemist, Field staff.	Stop work if audits indicate significant deviation from project plan. Implement immediate or long- term corrective actions. Communicate deficiencies to USACE Project Manager.	
Early phase of project: Have necessary audits been performed?	Review project phase and check to see if required audits have <i>been</i> satisfactorily completed.	Project Manager, Project Manager, Quality Control System Manager	Stop work if reviewer decides that absence of audit jeopardizes successful implementation of project plans. Immediately schedule necessary audits.	
Ongoing throughout project: Are daily quality control reports being prepared according to contract requirements?	Review Content and delivery schedules of daily quality control reports.	Project Manager, Task Manager, Project Chemist, Project Staff	Correct deficiencies in reports or reporting delays.	
Ongoing throughout project: Do project plans adequately address any changes in project activities or goal?	Compare data gathered to assess conformance to the project plan and conceptual site model.	Project Manager, Safety and Health Officer, Quality Control System Manager, Task Manager, Project Chemist, Field staff.	Stop work if assessor decides that project plan deficiencies are significant. Implement corrective action to include modification of project plans. Notify USACE Project Manager.	
Ongoing throughout project: Do project plans adequately address any changes in project activities or goals?	Compare data gathered to assess conformance to the conceptual site model, data quality objectives, and project plan.	Project Manager, Quality Control System Manager, Task Manager, Project Chemist, data users and evaluators.	Propose additional data collection activities to fill data gaps. Notify USACE Project Manager. Revise or update planning documents as appropriate.	

**INVESTIGATION, MONITORING, O&M PROJECTS
FOLLOW-UP PHASE INSPECTION COVER SHEET**

Contract No.: _____
Task No.: _____
Location/Project: _____

Date: _____

Project/Area of Inspection: _____

A. Key Personnel Present:

	<u>Name</u>	<u>Position</u>	<u>Company</u>
1.	_____	_____	_____
2.	_____	_____	_____
3.	_____	_____	_____
4.	_____	_____	_____
5.	_____	_____	_____
6.	_____	_____	_____
7.	_____	_____	_____
8.	_____	_____	_____
9.	_____	_____	_____
10.	_____	_____	_____

B. Definable Features of Work:

Status of Inspection:

Quality Control Manager

INVESTIGATION PROJECT FOLLOW-UP PHASE INSPECTION CHECKLIST

Assessment Activity	Assessment Mechanism	Person(s) Responsible	Response Action	Completed by/Date
Reporting phase of project: Have data reports been prepared in accordance with project plans?	Compare data reports to specifications detailed in planning documents.	Project Manager, Quality Control Manager, Task Manager, Project Chemist, data users and evaluators.	Revise documents and reports as appropriate.	
After draft report submittal or project completion: Are reports adequate to meet client and regulatory agency requirements?	Review client and agency comments. Prepare responses to comments.	Project Manager, Quality Control Manager, Task Manager, Project Chemist, data users and evaluators.	Revise documents and reports as appropriate.	
Have other definable features of work been completed in accordance to project requirements	Compare definable features of work with project requirements.	Project Manager, Quality Control Manager	Complete definable feature of work as required.	

ATTACHMENT D

ADR Library and Qualifier Tables

Project Target Analyte Reporting Limit, Blank Contamination, and Lab & Field Duplicate RPD Criteria

eQapp Name: FtOrd_UFP_QAPP_Rev9_3
Description: Quality Assurance Project Plan
 Former Fort Ord, California
 Volume I Appendix A

Target Analyte Name	Analyte Label (CAS)	Quantitation Limit	Detection Limit	Units	Blank Contamination Rule	LabDup RPD	FieldDup RPD
Method: EPA6010C Matrix: AQ							
ANTIMONY	7440-36-0	6.0	5.0	ug/L	5.00	20.00	30.00
COPPER	7440-50-8	25	2.0	ug/L	5.00	20.00	30.00
LEAD	7439-92-1	10	2.0	ug/L	5.00	20.00	30.00
Method: EPA6010D Matrix: AQ							
ANTIMONY	7440-36-0	6.0	5.0	ug/L	5.00	20.00	30.00
COPPER	7440-50-8	25	2.0	ug/L	5.00	20.00	30.00
LEAD	7439-92-1	10	2.0	ug/L	5.00	20.00	30.00
Method: EPA8260B Matrix: AQ							
1,1,1,2-TETRACHLOROETHANE	630-20-6	0.300	0.0380	ug/L	5.00	20.00	30.00
1,1,1-TRICHLOROETHANE	71-55-6	0.200	0.0250	ug/L	5.00	20.00	30.00
1,1,2,2-TETRACHLOROETHANE	79-34-5	0.200	0.0560	ug/L	5.00	20.00	30.00
1,1,2-TRICHLOROETHANE	79-00-5	0.200	0.0700	ug/L	5.00	20.00	30.00
1,1-DICHLOROETHANE	75-34-3	0.200	0.0250	ug/L	5.00	20.00	30.00
1,1-DICHLOROETHYLENE	75-35-4	0.200	0.0350	ug/L	5.00	20.00	30.00
1,1-DICHLOROPROPENE	563-58-6	0.200	0.0360	ug/L	5.00	20.00	30.00
1,2,3-TRICHLOROBENZENE	87-61-6	0.500	0.149	ug/L	5.00	20.00	30.00
1,2,3-TRICHLOROPROPANE	96-18-4	0.200	0.0500	ug/L	5.00	20.00	30.00
1,2,4-TRICHLOROBENZENE	120-82-1	0.500	0.172	ug/L	5.00	20.00	30.00
1,2,4-TRIMETHYLBENZENE	95-63-6	0.300	0.0720	ug/L	5.00	20.00	30.00
1,2-DIBROMO-3-CHLOROPROPANE	96-12-8	2.00	0.440	ug/L	5.00	20.00	30.00
1,2-DIBROMOETHANE	106-93-4	0.100	0.0250	ug/L	5.00	20.00	30.00
1,2-DICHLOROBENZENE	95-50-1	0.300	0.0380	ug/L	5.00	20.00	30.00
1,2-DICHLOROETHANE	107-06-2	0.200	0.0430	ug/L	5.00	20.00	30.00
1,2-DICHLOROPROPANE	78-87-5	0.200	0.0600	ug/L	5.00	20.00	30.00
1,3,5-TRIMETHYLBENZENE	108-67-8	0.500	0.152	ug/L	5.00	20.00	30.00
1,3-DICHLOROBENZENE	541-73-1	0.300	0.0500	ug/L	5.00	20.00	30.00
1,3-DICHLOROPROPANE	142-28-9	0.200	0.0250	ug/L	5.00	20.00	30.00

Target Analyte Name	Analyte Label (CAS)	Quantitation Limit	Detection Limit	Units	Blank Contamination Rule	LabDup RPD	FieldDup RPD	
Method: EPA8260B		Matrix: AQ						
1,4-DICHLOROBENZENE	106-46-7	0.300	0.0500	ug/L	5.00	20.00	30.00	
2,2-DICHLOROPROPANE	594-20-7	0.500	0.0600	ug/L	5.00	20.00	30.00	
2-CHLOROTOLUENE	95-49-8	0.500	0.116	ug/L	5.00	20.00	30.00	
4-CHLOROTOLUENE	106-43-4	0.300	0.0500	ug/L	5.00	20.00	30.00	
4-ISOPROPYLTOLUENE	99-87-6	0.500	0.146	ug/L	5.00	20.00	30.00	
BENZENE	71-43-2	0.200	0.0300	ug/L	5.00	20.00	30.00	
BROMOBENZENE	108-86-1	0.200	0.0380	ug/L	5.00	20.00	30.00	
BROMOFORM	75-25-2	0.500	0.157	ug/L	5.00	20.00	30.00	
BROMOMETHANE	74-83-9	0.500	0.0620	ug/L	5.00	20.00	30.00	
CARBON TETRACHLORIDE	56-23-5	0.200	0.0250	ug/L	5.00	20.00	30.00	
CHLOROBENZENE	108-90-7	0.200	0.0250	ug/L	5.00	20.00	30.00	
Chlorobromomethane	74-97-5	0.200	0.0250	ug/L	5.00	20.00	30.00	
CHLORODIBROMOMETHANE	124-48-1	0.200	0.0550	ug/L	5.00	20.00	30.00	
CHLOROETHANE	75-00-3	0.500	0.0960	ug/L	5.00	20.00	30.00	
CHLOROFORM	67-66-3	0.200	0.0300	ug/L	5.00	20.00	30.00	
CHLOROMETHANE	74-87-3	0.500	0.0680	ug/L	5.00	20.00	30.00	
CIS-1,2-DICHLOROETHYLENE	156-59-2	0.200	0.0550	ug/L	5.00	20.00	30.00	
CIS-1,3-DICHLOROPROPENE	10061-01-5	0.200	0.0900	ug/L	5.00	20.00	30.00	
DIBROMOMETHANE	74-95-3	0.200	0.0620	ug/L	5.00	20.00	30.00	
DICHLOROBROMOMETHANE	75-27-4	0.200	0.0600	ug/L	5.00	20.00	30.00	
DICHLORODIFLUOROMETHANE	75-71-8	0.400	0.128	ug/L	5.00	20.00	30.00	
ETHYLBENZENE	100-41-4	0.200	0.0300	ug/L	5.00	20.00	30.00	
HEXACHLOROBUTADIENE	87-68-3	0.500	0.0670	ug/L	5.00	20.00	30.00	
ISOPROPYLBENZENE	98-82-8	1.00	0.187	ug/L	5.00	20.00	30.00	
METHYL TERT-BUTYL ETHER	1634-04-4	0.300	0.0700	ug/L	5.00	20.00	30.00	
METHYLENE CHLORIDE	75-09-2	5.00	1.20	ug/L	10.00	20.00	30.00	
m-Xylene & p-Xylene	179601-23-1	0.500	0.115	ug/L	5.00	20.00	30.00	
NAPHTHALENE	91-20-3	1.00	0.221	ug/L	5.00	20.00	30.00	
N-BUTYLBENZENE	104-51-8	1.00	0.225	ug/L	5.00	20.00	30.00	
N-PROPYLBENZENE	103-65-1	0.300	0.0910	ug/L	5.00	20.00	30.00	
O-XYLENE	95-47-6	0.500	0.147	ug/L	5.00	20.00	30.00	
SEC-BUTYLBENZENE	135-98-8	1.00	0.168	ug/L	5.00	20.00	30.00	
STYRENE	100-42-5	1.00	0.192	ug/L	5.00	20.00	30.00	

Target Analyte Name	Analyte Label (CAS)	Quantitation Limit	Detection Limit	Units	Blank Contamination Rule	LabDup RPD	FieldDup RPD	
Method: EPA8260B		Matrix: AQ						
TERT-BUTYLBENZENE	98-06-6	0.500	0.257	ug/L	5.00	20.00	30.00	
TETRACHLOROETHYLENE	127-18-4	0.500	0.0840	ug/L	5.00	20.00	30.00	
TOLUENE	108-88-3	0.200	0.0500	ug/L	5.00	20.00	30.00	
TRANS-1,2-DICHLOROETHENE	156-60-5	0.200	0.0330	ug/L	5.00	20.00	30.00	
TRANS-1,3-DICHLOROPROPENE	10061-02-6	0.200	0.0920	ug/L	5.00	20.00	30.00	
Trichloroethylene	79-01-6	0.200	0.0660	ug/L	5.00	20.00	30.00	
TRICHLOROFUOROMETHANE	75-69-4	0.500	0.0430	ug/L	5.00	20.00	30.00	
VINYL CHLORIDE	75-01-4	0.0200	0.0130	ug/L	5.00	20.00	30.00	
Method: EPA8260-SIM		Matrix: AQ						
1,1,1,2-TETRACHLOROETHANE	630-20-6	0.300	0.0380	ug/L	5.00	20.00	30.00	
1,1,1-TRICHLOROETHANE	71-55-6	0.200	0.0250	ug/L	5.00	20.00	30.00	
1,1,2,2-TETRACHLOROETHANE	79-34-5	0.200	0.0560	ug/L	5.00	20.00	30.00	
1,1,2-TRICHLOROETHANE	79-00-5	0.200	0.0700	ug/L	5.00	20.00	30.00	
1,1-DICHLOROETHANE	75-34-3	0.200	0.0250	ug/L	5.00	20.00	30.00	
1,1-DICHLOROETHYLENE	75-35-4	0.200	0.0350	ug/L	5.00	20.00	30.00	
1,1-DICHLOROPROPENE	563-58-6	0.200	0.0360	ug/L	5.00	20.00	30.00	
1,2,3-TRICHLOROENZENE	87-61-6	0.500	0.149	ug/L	5.00	20.00	30.00	
1,2,3-TRICHLOROPROPANE	96-18-4	0.200	0.0500	ug/L	5.00	20.00	30.00	
1,2,4-TRICHLOROENZENE	120-82-1	0.500	0.172	ug/L	5.00	20.00	30.00	
1,2,4-TRIMETHYLBENZENE	95-63-6	0.300	0.0720	ug/L	5.00	20.00	30.00	
1,2-DIBROMO-3-CHLOROPROPANE	96-12-8	2.00	0.440	ug/L	5.00	20.00	30.00	
1,2-DIBROMOETHANE	106-93-4	0.100	0.0250	ug/L	5.00	20.00	30.00	
1,2-DICHLOROENZENE	95-50-1	0.300	0.0380	ug/L	5.00	20.00	30.00	
1,2-DICHLOROETHANE	107-06-2	0.200	0.0430	ug/L	5.00	20.00	30.00	
1,2-DICHLOROPROPANE	78-87-5	0.200	0.0600	ug/L	5.00	20.00	30.00	
1,3,5-TRIMETHYLBENZENE	108-67-8	0.500	0.152	ug/L	5.00	20.00	30.00	
1,3-DICHLOROENZENE	541-73-1	0.300	0.0500	ug/L	5.00	20.00	30.00	
1,3-DICHLOROPROPANE	142-28-9	0.200	0.0250	ug/L	5.00	20.00	30.00	
1,3-Dichloropropene (total)	542-75-6	0.50	0.25	ug/L	5.00	20.00	30.00	
1,4-DICHLOROENZENE	106-46-7	0.300	0.0500	ug/L	5.00	20.00	30.00	
2,2-DICHLOROPROPANE	594-20-7	0.500	0.0600	ug/L	5.00	20.00	30.00	
2-CHLOROTOLUENE	95-49-8	0.500	0.116	ug/L	5.00	20.00	30.00	

Target Analyte Name	Analyte Label (CAS)	Quantitation Limit	Detection Limit	Units	Blank Contamination Rule	LabDup RPD	FieldDup RPD	
Method: EPA8260-SIM		Matrix: AQ						
4-CHLOROTOLUENE	106-43-4	0.300	0.0500	ug/L	5.00	20.00	30.00	
4-ISOPROPYLTOLUENE	99-87-6	0.500	0.146	ug/L	5.00	20.00	30.00	
BENZENE	71-43-2	0.200	0.0300	ug/L	5.00	20.00	30.00	
BROMOBENZENE	108-86-1	0.200	0.0380	ug/L	5.00	20.00	30.00	
BROMOFORM	75-25-2	0.500	0.157	ug/L	5.00	20.00	30.00	
BROMOMETHANE	74-83-9	0.500	0.0620	ug/L	5.00	20.00	30.00	
CARBON TETRACHLORIDE	56-23-5	0.200	0.0250	ug/L	5.00	20.00	30.00	
CHLOROENZENE	108-90-7	0.200	0.0250	ug/L	5.00	20.00	30.00	
Chlorobromomethane	74-97-5	0.200	0.0250	ug/L	5.00	20.00	30.00	
CHLORODIBROMOMETHANE	124-48-1	0.200	0.0550	ug/L	5.00	20.00	30.00	
CHLOROETHANE	75-00-3	0.500	0.0960	ug/L	5.00	20.00	30.00	
CHLOROFORM	67-66-3	0.200	0.0300	ug/L	5.00	20.00	30.00	
CHLOROMETHANE	74-87-3	0.500	0.0680	ug/L	5.00	20.00	30.00	
CIS-1,2-DICHLOROETHYLENE	156-59-2	0.200	0.0550	ug/L	5.00	20.00	30.00	
CIS-1,3-DICHLOROPROPENE	10061-01-5	0.200	0.0900	ug/L	5.00	20.00	30.00	
DIBROMOMETHANE	74-95-3	0.200	0.0620	ug/L	5.00	20.00	30.00	
DICHLOROBROMOMETHANE	75-27-4	0.200	0.0600	ug/L	5.00	20.00	30.00	
DICHLORODIFLUOROMETHANE	75-71-8	0.400	0.128	ug/L	5.00	20.00	30.00	
ETHYLBENZENE	100-41-4	0.200	0.0300	ug/L	5.00	20.00	30.00	
HEXACHLOROBUTADIENE	87-68-3	0.500	0.0670	ug/L	5.00	20.00	30.00	
ISOPROPYLBENZENE	98-82-8	1.00	0.187	ug/L	5.00	20.00	30.00	
METHYL TERT-BUTYL ETHER	1634-04-4	0.300	0.0700	ug/L	5.00	20.00	30.00	
METHYLENE CHLORIDE	75-09-2	5.00	1.20	ug/L	10.00	20.00	30.00	
m-Xylene & p-Xylene	179601-23-1	0.500	0.115	ug/L	5.00	20.00	30.00	
NAPHTHALENE	91-20-3	1.00	0.221	ug/L	5.00	20.00	30.00	
N-BUTYLBENZENE	104-51-8	1.00	0.225	ug/L	5.00	20.00	30.00	
N-PROPYLBENZENE	103-65-1	0.300	0.0910	ug/L	5.00	20.00	30.00	
O-XYLENE	95-47-6	0.500	0.147	ug/L	5.00	20.00	30.00	
SEC-BUTYLBENZENE	135-98-8	1.00	0.168	ug/L	5.00	20.00	30.00	
STYRENE	100-42-5	1.00	0.192	ug/L	5.00	20.00	30.00	
TERT-BUTYLBENZENE	98-06-6	0.500	0.257	ug/L	5.00	20.00	30.00	
TETRACHLOROETHYLENE	127-18-4	0.500	0.0840	ug/L	5.00	20.00	30.00	
TOLUENE	108-88-3	0.200	0.0500	ug/L	5.00	20.00	30.00	

Target Analyte Name	Analyte Label (CAS)	Quantitation Limit	Detection Limit	Units	Blank Contamination Rule	LabDup RPD	FieldDup RPD	
Method: EPA8260-SIM		Matrix: AQ						
TRANS-1,2-DICHLOROETHENE	156-60-5	0.200	0.0330	ug/L	5.00	20.00	30.00	
TRANS-1,3-DICHLOROPROPENE	10061-02-6	0.200	0.0920	ug/L	5.00	20.00	30.00	
Trichloroethylene	79-01-6	0.200	0.0660	ug/L	5.00	20.00	30.00	
TRICHLOROFUOROMETHANE	75-69-4	0.500	0.0430	ug/L	5.00	20.00	30.00	
VINYL CHLORIDE	75-01-4	0.0200	0.0130	ug/L	5.00	20.00	30.00	
Method: EPA9056A		Matrix: AQ						
CHLORIDE	16887-00-6	250	0.80	mg/L	5.00	20.00	30.00	
Method: SW846 6010D		Matrix: AQ						
ANTIMONY	7440-36-0	6.0	5.0	ug/L	5.00	20.00	30.00	
COPPER	7440-50-8	25	2.0	ug/L	5.00	20.00	30.00	
LEAD	7439-92-1	10	2.0	ug/L	5.00	20.00	30.00	

Project Accuracy and Precision Report

eQapp Name: FtOrd_UFP_QAPP_Rev9_3
Description: Quality Assurance Project Plan
 Former Fort Ord, California
 Volume I Appendix A

Analyte Name	Analyte Label (CAS)	Lower Rejection (%)	Lower Recovery (%)	Upper Recovery (%)	Upper Rejection (%)	RPD (%)
Method: EPA6010C		Matrix: AQ				
QC Type: LCS						
ANTIMONY	7440-36-0	50.00	88.00	113.00		20.00
COPPER	7440-50-8	50.00	86.00	114.00		20.00
LEAD	7439-92-1	50.00	86.00	113.00		20.00
QC Type: MS						
ANTIMONY	7440-36-0	30.00	88.00	113.00		20.00
COPPER	7440-50-8	30.00	86.00	114.00		20.00
LEAD	7439-92-1	30.00	86.00	113.00		20.00
Method: EPA6010D		Matrix: AQ				
QC Type: LCS						
ANTIMONY	7440-36-0	50.00	88.00	113.00		20.00
COPPER	7440-50-8	50.00	86.00	114.00		20.00
LEAD	7439-92-1	50.00	86.00	113.00		20.00
QC Type: MS						
ANTIMONY	7440-36-0	30.00	88.00	113.00		20.00
COPPER	7440-50-8	30.00	86.00	114.00		20.00
LEAD	7439-92-1	30.00	86.00	113.00		20.00
Method: EPA8260B		Matrix: AQ				
QC Type: LCS						
1,1,1,2-TETRACHLOROETHANE	630-20-6	10.00	78.00	124.00		20.00
1,1,1-TRICHLOROETHANE	71-55-6	10.00	74.00	131.00		20.00
1,1,2,2-TETRACHLOROETHANE	79-34-5	10.00	71.00	121.00		20.00

Analyte Name	Analyte Label (CAS)	Lower Rejection (%)	Lower Recovery (%)	Upper Recovery (%)	Upper Rejection (%)	RPD (%)
Method: EPA8260B		Matrix: AQ				
QC Type: LCS						
1,1,2-TRICHLOROETHANE	79-00-5	10.00	80.00	119.00		20.00
1,1-DICHLOROETHANE	75-34-3	10.00	77.00	125.00		20.00
1,1-DICHLOROETHYLENE	75-35-4	10.00	71.00	131.00		20.00
1,1-DICHLOROPROPENE	563-58-6	10.00	79.00	125.00		20.00
1,2,3-TRICHLOROBENZENE	87-61-6	10.00	69.00	129.00		20.00
1,2,3-TRICHLOROPROPANE	96-18-4	10.00	73.00	122.00		20.00
1,2,4-TRICHLOROBENZENE	120-82-1	10.00	69.00	130.00		20.00
1,2,4-TRIMETHYLBENZENE	95-63-6	10.00	76.00	124.00		20.00
1,2-DIBROMO-3-CHLOROPROPANE	96-12-8	10.00	62.00	128.00		20.00
1,2-DIBROMOETHANE	106-93-4	10.00	77.00	121.00		20.00
1,2-DICHLOROBENZENE	95-50-1	10.00	80.00	119.00		20.00
1,2-DICHLOROETHANE	107-06-2	10.00	73.00	128.00		20.00
1,2-DICHLOROPROPANE	78-87-5	10.00	78.00	122.00		20.00
1,3,5-TRIMETHYLBENZENE	108-67-8	10.00	75.00	124.00		20.00
1,3-DICHLOROBENZENE	541-73-1	10.00	80.00	119.00		20.00
1,3-DICHLOROPROPANE	142-28-9	10.00	80.00	119.00		20.00
1,4-DICHLOROBENZENE	106-46-7	10.00	79.00	118.00		20.00
2,2-DICHLOROPROPANE	594-20-7	10.00	60.00	139.00		20.00
2-CHLOROTOLUENE	95-49-8	10.00	79.00	122.00		20.00
4-CHLOROTOLUENE	106-43-4	10.00	78.00	122.00		20.00
4-ISOPROPYLTOLUENE	99-87-6	10.00	77.00	127.00		20.00
BENZENE	71-43-2	10.00	79.00	120.00		20.00
BROMOBENZENE	108-86-1	10.00	80.00	120.00		20.00
BROMOFORM	75-25-2	10.00	66.00	130.00		20.00
BROMOMETHANE	74-83-9	10.00	53.00	141.00		20.00
CARBON TETRACHLORIDE	56-23-5	10.00	72.00	136.00		20.00
CHLOROBENZENE	108-90-7	10.00	82.00	118.00		20.00
Chlorobromomethane	74-97-5	10.00	78.00	123.00		20.00
CHLORODIBROMOMETHANE	124-48-1	10.00	74.00	126.00		20.00
CHLOROETHANE	75-00-3	10.00	60.00	138.00		20.00
CHLOROFORM	67-66-3	10.00	79.00	124.00		20.00
CHLOROMETHANE	74-87-3	10.00	50.00	139.00		20.00

Analyte Name	Analyte Label (CAS)	Lower Rejection (%)	Lower Recovery (%)	Upper Recovery (%)	Upper Rejection (%)	RPD (%)
Method: EPA8260B		Matrix: AQ				
QC Type: LCS						
CIS-1,2-DICHLOROETHYLENE	156-59-2	10.00	78.00	123.00		20.00
CIS-1,3-DICHLOROPROPENE	10061-01-5	10.00	75.00	124.00		20.00
DIBROMOMETHANE	74-95-3	10.00	79.00	123.00		20.00
DICHLOROBROMOMETHANE	75-27-4	10.00	79.00	125.00		20.00
DICHLORODIFLUOROMETHANE	75-71-8	10.00	32.00	152.00		20.00
ETHYLBENZENE	100-41-4	10.00	79.00	121.00		20.00
HEXACHLOROBUTADIENE	87-68-3	10.00	66.00	134.00		20.00
ISOPROPYLBENZENE	98-82-8	10.00	72.00	131.00		20.00
METHYL TERT-BUTYL ETHER	1634-04-4	10.00	71.00	124.00		20.00
METHYLENE CHLORIDE	75-09-2	10.00	74.00	124.00		20.00
m-Xylene & p-Xylene	179601-23-1	10.00	80.00	121.00		20.00
NAPHTHALENE	91-20-3	10.00	61.00	128.00		20.00
N-BUTYLBENZENE	104-51-8	10.00	75.00	128.00		20.00
N-PROPYLBENZENE	103-65-1	10.00	76.00	126.00		20.00
O-XYLENE	95-47-6	10.00	78.00	122.00		20.00
SEC-BUTYLBENZENE	135-98-8	10.00	77.00	126.00		20.00
STYRENE	100-42-5	10.00	78.00	123.00		20.00
TERT-BUTYLBENZENE	98-06-6	10.00	78.00	124.00		20.00
TETRACHLOROETHYLENE	127-18-4	10.00	74.00	129.00		20.00
TOLUENE	108-88-3	10.00	80.00	121.00		20.00
TRANS-1,2-DICHLOROETHENE	156-60-5	10.00	75.00	124.00		20.00
TRANS-1,3-DICHLOROPROPENE	10061-02-6	10.00	73.00	127.00		20.00
Trichloroethylene	79-01-6	10.00	79.00	123.00		20.00
TRICHLOROFLUOROMETHANE	75-69-4	10.00	65.00	141.00		20.00
VINYL CHLORIDE	75-01-4	10.00	58.00	137.00		20.00
QC Type: MS						
1,1,1,2-TETRACHLOROETHANE	630-20-6	0.01	78.00	124.00		20.00
1,1,1-TRICHLOROETHANE	71-55-6	0.01	74.00	131.00		20.00
1,1,2,2-TETRACHLOROETHANE	79-34-5	0.01	71.00	121.00		20.00
1,1,2-TRICHLOROETHANE	79-00-5	0.01	80.00	119.00		20.00
1,1-DICHLOROETHANE	75-34-3	0.01	77.00	125.00		20.00

Analyte Name	Analyte Label (CAS)	Lower Rejection (%)	Lower Recovery (%)	Upper Recovery (%)	Upper Rejection (%)	RPD (%)
Method: EPA8260B		Matrix: AQ				
QC Type: MS						
1,1-DICHLOROETHYLENE	75-35-4	0.01	71.00	131.00		20.00
1,1-DICHLOROPROPENE	563-58-6	0.01	79.00	125.00		20.00
1,2,3-TRICHLOROBENZENE	87-61-6	0.01	69.00	129.00		20.00
1,2,3-TRICHLOROPROPANE	96-18-4	0.01	73.00	122.00		20.00
1,2,4-TRICHLOROBENZENE	120-82-1	0.01	69.00	130.00		20.00
1,2,4-TRIMETHYLBENZENE	95-63-6	0.01	76.00	124.00		20.00
1,2-DIBROMO-3-CHLOROPROPANE	96-12-8	0.01	62.00	128.00		20.00
1,2-DIBROMOETHANE	106-93-4	0.01	77.00	121.00		20.00
1,2-DICHLOROBENZENE	95-50-1	0.01	80.00	119.00		20.00
1,2-DICHLOROETHANE	107-06-2	0.01	73.00	128.00		20.00
1,2-DICHLOROPROPANE	78-87-5	0.01	78.00	122.00		20.00
1,3,5-TRIMETHYLBENZENE	108-67-8	0.01	75.00	124.00		20.00
1,3-DICHLOROBENZENE	541-73-1	0.01	80.00	119.00		20.00
1,3-DICHLOROPROPANE	142-28-9	0.01	80.00	119.00		20.00
1,4-DICHLOROBENZENE	106-46-7	0.01	79.00	118.00		20.00
2,2-DICHLOROPROPANE	594-20-7	0.01	60.00	139.00		20.00
2-CHLOROTOLUENE	95-49-8	0.01	79.00	122.00		20.00
4-CHLOROTOLUENE	106-43-4	0.01	78.00	122.00		20.00
4-ISOPROPYLTOLUENE	99-87-6	0.01	77.00	127.00		20.00
BENZENE	71-43-2	0.01	79.00	120.00		20.00
BROMOBENZENE	108-86-1	0.01	80.00	120.00		20.00
BROMOFORM	75-25-2	0.01	66.00	130.00		20.00
BROMOMETHANE	74-83-9	0.01	53.00	141.00		20.00
CARBON TETRACHLORIDE	56-23-5	0.01	72.00	136.00		20.00
CHLOROBENZENE	108-90-7	0.01	82.00	118.00		20.00
Chlorobromomethane	74-97-5	0.01	78.00	123.00		20.00
CHLORODIBROMOMETHANE	124-48-1	0.01	74.00	126.00		20.00
CHLOROETHANE	75-00-3	0.01	60.00	138.00		20.00
CHLOROFORM	67-66-3	0.01	79.00	124.00		20.00
CHLOROMETHANE	74-87-3	0.01	50.00	139.00		20.00
CIS-1,2-DICHLOROETHYLENE	156-59-2	0.01	78.00	123.00		20.00
CIS-1,3-DICHLOROPROPENE	10061-01-5	0.01	75.00	124.00		20.00

Analyte Name	Analyte Label (CAS)	Lower Rejection (%)	Lower Recovery (%)	Upper Recovery (%)	Upper Rejection (%)	RPD (%)
Method: EPA8260B		Matrix: AQ				
QC Type: MS						
DIBROMOMETHANE	74-95-3	0.01	79.00	123.00		20.00
DICHLOROBROMOMETHANE	75-27-4	0.01	79.00	125.00		20.00
DICHLORODIFLUOROMETHANE	75-71-8	0.01	32.00	152.00		20.00
ETHYLBENZENE	100-41-4	0.01	79.00	121.00		20.00
HEXACHLOROBUTADIENE	87-68-3	0.01	66.00	134.00		20.00
ISOPROPYLBENZENE	98-82-8	0.01	72.00	131.00		20.00
METHYL TERT-BUTYL ETHER	1634-04-4	0.01	71.00	124.00		20.00
METHYLENE CHLORIDE	75-09-2	0.01	74.00	124.00		20.00
m-Xylene & p-Xylene	179601-23-1	0.01	80.00	121.00		20.00
NAPHTHALENE	91-20-3	0.01	61.00	128.00		20.00
N-BUTYLBENZENE	104-51-8	0.01	75.00	128.00		20.00
N-PROPYLBENZENE	103-65-1	0.01	76.00	126.00		20.00
O-XYLENE	95-47-6	0.01	78.00	122.00		20.00
SEC-BUTYLBENZENE	135-98-8	0.01	77.00	126.00		20.00
STYRENE	100-42-5	0.01	78.00	123.00		20.00
TERT-BUTYLBENZENE	98-06-6	0.01	78.00	124.00		20.00
TETRACHLOROETHYLENE	127-18-4	0.01	74.00	129.00		20.00
TOLUENE	108-88-3	0.01	80.00	121.00		20.00
TRANS-1,2-DICHLOROETHENE	156-60-5	0.01	75.00	124.00		20.00
TRANS-1,3-DICHLOROPROPENE	10061-02-6	0.01	73.00	127.00		20.00
Trichloroethylene	79-01-6	0.01	79.00	123.00		20.00
TRICHLOROFLUOROMETHANE	75-69-4	0.01	65.00	141.00		20.00
VINYL CHLORIDE	75-01-4	0.01	58.00	137.00		20.00
QC Type: SURR						
1,2-Dichloroethane-d4 (Surr)	17060-07-0	10.00	81.00	118.00		
4-BROMOFLUOROBENZENE (SURR)	460-00-4	10.00	85.00	114.00		
Dibromofluoromethane (Surr)	1868-53-7	10.00	80.00	119.00		
Toluene-d8 (Surr)	2037-26-5	10.00	89.00	112.00		
Trifluorotoluene (Surr)	98-08-8	10.00	70.00	136.00		

Analyte Name	Analyte Label (CAS)	Lower Rejection (%)	Lower Recovery (%)	Upper Recovery (%)	Upper Rejection (%)	RPD (%)
Method: EPA8260-SIM		Matrix: AQ				
QC Type: LCS						
1,1,1,2-TETRACHLOROETHANE	630-20-6	10.00	78.00	124.00		20.00
1,1,1-TRICHLOROETHANE	71-55-6	10.00	74.00	131.00		20.00
1,1,2,2-TETRACHLOROETHANE	79-34-5	10.00	71.00	121.00		20.00
1,1,2-TRICHLOROETHANE	79-00-5	10.00	80.00	119.00		20.00
1,1-DICHLOROETHANE	75-34-3	10.00	77.00	125.00		20.00
1,1-DICHLOROETHYLENE	75-35-4	10.00	71.00	131.00		20.00
1,1-DICHLOROPROPENE	563-58-6	10.00	79.00	125.00		20.00
1,2,3-TRICHLOROBENZENE	87-61-6	10.00	69.00	129.00		20.00
1,2,3-TRICHLOROPROPANE	96-18-4	10.00	73.00	122.00		20.00
1,2,4-TRICHLOROBENZENE	120-82-1	10.00	69.00	130.00		20.00
1,2,4-TRIMETHYLBENZENE	95-63-6	10.00	76.00	124.00		20.00
1,2-DIBROMO-3-CHLOROPROPANE	96-12-8	10.00	62.00	128.00		20.00
1,2-DIBROMOETHANE	106-93-4	10.00	77.00	121.00		20.00
1,2-DICHLOROBENZENE	95-50-1	10.00	80.00	119.00		20.00
1,2-DICHLOROETHANE	107-06-2	10.00	73.00	128.00		20.00
1,2-DICHLOROPROPANE	78-87-5	10.00	78.00	122.00		20.00
1,3,5-TRIMETHYLBENZENE	108-67-8	10.00	75.00	124.00		20.00
1,3-DICHLOROBENZENE	541-73-1	10.00	80.00	119.00		20.00
1,3-DICHLOROPROPANE	142-28-9	10.00	80.00	119.00		20.00
1,3-Dichloropropene (total)	542-75-6	10.00	77.00	123.00		20.00
1,4-DICHLOROBENZENE	106-46-7	10.00	79.00	118.00		20.00
2,2-DICHLOROPROPANE	594-20-7	10.00	60.00	139.00		20.00
2-CHLOROTOLUENE	95-49-8	10.00	79.00	122.00		20.00
4-CHLOROTOLUENE	106-43-4	10.00	78.00	122.00		20.00
4-ISOPROPYLTOLUENE	99-87-6	10.00	77.00	127.00		20.00
BENZENE	71-43-2	10.00	79.00	120.00		20.00
BROMOBENZENE	108-86-1	10.00	80.00	120.00		20.00
BROMOFORM	75-25-2	10.00	66.00	130.00		20.00
BROMOMETHANE	74-83-9	10.00	53.00	141.00		20.00
CARBON TETRACHLORIDE	56-23-5	10.00	72.00	136.00		20.00
CHLOROBENZENE	108-90-7	10.00	82.00	118.00		20.00
Chlorobromomethane	74-97-5	10.00	78.00	123.00		20.00

Analyte Name	Analyte Label (CAS)	Lower Rejection (%)	Lower Recovery (%)	Upper Recovery (%)	Upper Rejection (%)	RPD (%)
Method: EPA8260-SIM		Matrix: AQ				
QC Type: LCS						
CHLORODIBROMOMETHANE	124-48-1	10.00	74.00	126.00		20.00
CHLOROETHANE	75-00-3	10.00	60.00	138.00		20.00
CHLOROFORM	67-66-3	10.00	79.00	124.00		20.00
CHLOROMETHANE	74-87-3	10.00	50.00	139.00		20.00
CIS-1,2-DICHLOROETHYLENE	156-59-2	10.00	78.00	123.00		20.00
CIS-1,3-DICHLOROPROPENE	10061-01-5	10.00	75.00	124.00		20.00
DIBROMOMETHANE	74-95-3	10.00	79.00	123.00		20.00
DICHLOROBROMOMETHANE	75-27-4	10.00	79.00	125.00		20.00
DICHLORODIFLUOROMETHANE	75-71-8	10.00	32.00	152.00		20.00
ETHYLBENZENE	100-41-4	10.00	79.00	121.00		20.00
HEXACHLOROBUTADIENE	87-68-3	10.00	66.00	134.00		20.00
ISOPROPYLBENZENE	98-82-8	10.00	72.00	131.00		20.00
METHYL TERT-BUTYL ETHER	1634-04-4	10.00	71.00	124.00		20.00
METHYLENE CHLORIDE	75-09-2	10.00	74.00	124.00		20.00
m-Xylene & p-Xylene	179601-23-1	10.00	80.00	121.00		20.00
NAPHTHALENE	91-20-3	10.00	61.00	128.00		20.00
N-BUTYLBENZENE	104-51-8	10.00	75.00	128.00		20.00
N-PROPYLBENZENE	103-65-1	10.00	76.00	126.00		20.00
O-XYLENE	95-47-6	10.00	78.00	122.00		20.00
SEC-BUTYLBENZENE	135-98-8	10.00	77.00	126.00		20.00
STYRENE	100-42-5	10.00	78.00	123.00		20.00
TERT-BUTYLBENZENE	98-06-6	10.00	78.00	124.00		20.00
TETRACHLOROETHYLENE	127-18-4	10.00	74.00	129.00		20.00
TOLUENE	108-88-3	10.00	80.00	121.00		20.00
TRANS-1,2-DICHLOROETHENE	156-60-5	10.00	75.00	124.00		20.00
TRANS-1,3-DICHLOROPROPENE	10061-02-6	10.00	73.00	127.00		20.00
Trichloroethylene	79-01-6	10.00	79.00	123.00		20.00
TRICHLOROFLUOROMETHANE	75-69-4	10.00	65.00	141.00		20.00
VINYL CHLORIDE	75-01-4	10.00	58.00	137.00		20.00
QC Type: MS						
1,1,1,2-TETRACHLOROETHANE	630-20-6	0.01	78.00	124.00		20.00

Analyte Name	Analyte Label (CAS)	Lower Rejection (%)	Lower Recovery (%)	Upper Recovery (%)	Upper Rejection (%)	RPD (%)
Method: EPA8260-SIM		Matrix: AQ				
QC Type: MS						
1,1,1-TRICHLOROETHANE	71-55-6	0.01	74.00	131.00		20.00
1,1,2,2-TETRACHLOROETHANE	79-34-5	0.01	71.00	121.00		20.00
1,1,2-TRICHLOROETHANE	79-00-5	0.01	80.00	119.00		20.00
1,1-DICHLOROETHANE	75-34-3	0.01	77.00	125.00		20.00
1,1-DICHLOROETHYLENE	75-35-4	0.01	71.00	131.00		20.00
1,1-DICHLOROPROPENE	563-58-6	0.01	79.00	125.00		20.00
1,2,3-TRICHLOROBENZENE	87-61-6	0.01	69.00	129.00		20.00
1,2,3-TRICHLOROPROPANE	96-18-4	0.01	73.00	122.00		20.00
1,2,4-TRICHLOROBENZENE	120-82-1	0.01	69.00	130.00		20.00
1,2,4-TRIMETHYLBENZENE	95-63-6	0.01	76.00	124.00		20.00
1,2-DIBROMO-3-CHLOROPROPANE	96-12-8	0.01	62.00	128.00		20.00
1,2-DIBROMOETHANE	106-93-4	0.01	77.00	121.00		20.00
1,2-DICHLOROBENZENE	95-50-1	0.01	80.00	119.00		20.00
1,2-DICHLOROETHANE	107-06-2	0.01	73.00	128.00		20.00
1,2-DICHLOROPROPANE	78-87-5	0.01	78.00	122.00		20.00
1,3,5-TRIMETHYLBENZENE	108-67-8	0.01	75.00	124.00		20.00
1,3-DICHLOROBENZENE	541-73-1	0.01	80.00	119.00		20.00
1,3-DICHLOROPROPANE	142-28-9	0.01	80.00	119.00		20.00
1,3-Dichloropropene (total)	542-75-6	0.01	77.00	123.00		20.00
1,4-DICHLOROBENZENE	106-46-7	0.01	79.00	118.00		20.00
2,2-DICHLOROPROPANE	594-20-7	0.01	60.00	139.00		20.00
2-CHLOROTOLUENE	95-49-8	0.01	79.00	122.00		20.00
4-CHLOROTOLUENE	106-43-4	0.01	78.00	122.00		20.00
4-ISOPROPYLTOLUENE	99-87-6	0.01	77.00	127.00		20.00
BENZENE	71-43-2	0.01	79.00	120.00		20.00
BROMOBENZENE	108-86-1	0.01	80.00	120.00		20.00
BROMOFORM	75-25-2	0.01	66.00	130.00		20.00
BROMOMETHANE	74-83-9	0.01	53.00	141.00		20.00
CARBON TETRACHLORIDE	56-23-5	0.01	72.00	136.00		20.00
CHLOROBENZENE	108-90-7	0.01	82.00	118.00		20.00
Chlorobromomethane	74-97-5	0.01	78.00	123.00		20.00
CHLORODIBROMOMETHANE	124-48-1	0.01	74.00	126.00		20.00

Analyte Name	Analyte Label (CAS)	Lower Rejection (%)	Lower Recovery (%)	Upper Recovery (%)	Upper Rejection (%)	RPD (%)
Method: EPA8260-SIM		Matrix: AQ				
QC Type: MS						
CHLOROETHANE	75-00-3	0.01	60.00	138.00		20.00
CHLOROFORM	67-66-3	0.01	79.00	124.00		20.00
CHLOROMETHANE	74-87-3	0.01	50.00	139.00		20.00
CIS-1,2-DICHLOROETHYLENE	156-59-2	0.01	78.00	123.00		20.00
CIS-1,3-DICHLOROPROPENE	10061-01-5	0.01	75.00	124.00		20.00
DIBROMOMETHANE	74-95-3	0.01	79.00	123.00		20.00
DICHLOROBROMOMETHANE	75-27-4	0.01	79.00	125.00		20.00
DICHLORODIFLUOROMETHANE	75-71-8	0.01	32.00	152.00		20.00
ETHYLBENZENE	100-41-4	0.01	79.00	121.00		20.00
HEXACHLOROBUTADIENE	87-68-3	0.01	66.00	134.00		20.00
ISOPROPYLBENZENE	98-82-8	0.01	72.00	131.00		20.00
METHYL TERT-BUTYL ETHER	1634-04-4	0.01	71.00	124.00		20.00
METHYLENE CHLORIDE	75-09-2	0.01	74.00	124.00		20.00
m-Xylene & p-Xylene	179601-23-1	0.01	80.00	121.00		20.00
NAPHTHALENE	91-20-3	0.01	61.00	128.00		20.00
N-BUTYLBENZENE	104-51-8	0.01	75.00	128.00		20.00
N-PROPYLBENZENE	103-65-1	0.01	76.00	126.00		20.00
O-XYLENE	95-47-6	0.01	78.00	122.00		20.00
SEC-BUTYLBENZENE	135-98-8	0.01	77.00	126.00		20.00
STYRENE	100-42-5	0.01	78.00	123.00		20.00
TERT-BUTYLBENZENE	98-06-6	0.01	78.00	124.00		20.00
TETRACHLOROETHYLENE	127-18-4	0.01	74.00	129.00		20.00
TOLUENE	108-88-3	0.01	80.00	121.00		20.00
TRANS-1,2-DICHLOROETHENE	156-60-5	0.01	75.00	124.00		20.00
TRANS-1,3-DICHLOROPROPENE	10061-02-6	0.01	73.00	127.00		20.00
Trichloroethylene	79-01-6	0.01	79.00	123.00		20.00
TRICHLOROFLUOROMETHANE	75-69-4	0.01	65.00	141.00		20.00
VINYL CHLORIDE	75-01-4	0.01	58.00	137.00		20.00
QC Type: SURR						
1,2-Dichloroethane-d4 (Surr)	17060-07-0	10.00	81.00	118.00		
4-BROMOFLUOROBENZENE (SURR)	460-00-4	10.00	85.00	114.00		

Analyte Name	Analyte Label (CAS)	Lower Rejection (%)	Lower Recovery (%)	Upper Recovery (%)	Upper Rejection (%)	RPD (%)
Method: EPA8260-SIM		Matrix: AQ				
QC Type: SURR						
Dibromofluoromethane (Surr)	1868-53-7	10.00	80.00	119.00		
Toluene-d8 (Surr)	2037-26-5	10.00	89.00	112.00		
Trifluorotoluene (Surr)	98-08-8	10.00	70.00	136.00		
Method: EPA9056A		Matrix: AQ				
QC Type: LCS						
CHLORIDE	16887-00-6	50.00	90.00	110.00		
QC Type: MS						
CHLORIDE	16887-00-6	30.00	90.00	110.00		20.00
Method: SW846 6010D		Matrix: AQ				
QC Type: LCS						
ANTIMONY	7440-36-0	50.00	88.00	113.00		20.00
COPPER	7440-50-8	50.00	86.00	114.00		20.00
LEAD	7439-92-1	50.00	86.00	113.00		20.00
QC Type: MS						
ANTIMONY	7440-36-0	30.00	88.00	113.00		20.00
COPPER	7440-50-8	30.00	86.00	114.00		20.00
LEAD	7439-92-1	30.00	86.00	113.00		20.00

Project Holding Time Report

eQapp Name: FtOrd_UFP_QAPP_Rev9_3
Description: Quality Assurance Project Plan
 Former Fort Ord, California
 Volume I Appendix A

Analyte Group	Sampling to Analysis	Sampling to Extraction	Sampling to Leaching	Leaching to Extraction	Leaching to Analysis	Extraction to Analysis	Units	Rejection Factor
Method: EPA6010C Matrix: AQ								
Primary	180.00						Days	2.00
Method: EPA6010D Matrix: AQ								
Primary	180.00						Days	2.00
Method: EPA8260B Matrix: AQ								
Primary	14.00						Days	2.00
Method: EPA8260-SIM Matrix: AQ								
Primary	14.00						Days	2.00
Method: EPA9056A Matrix: AQ								
Primary	28.00						Days	2.00
Method: SW846 6010D Matrix: AQ								
Primary	180.00						Days	2.00

ADR Data Qualification Table

Description	VOA	
	Detect Qualifier	Non-detect Qualifier
Calibration Blank Contamination	U	
Continuing Calibration Verification Percent Difference Lower Estimation	J-	UJ
Continuing Calibration Verification Percent Difference Lower Rejection	J-	X
Continuing Calibration Verification Percent Difference Upper Estimation	J+	
Continuing Calibration Verification Percent Difference Upper Rejection	J+	No qual
Continuing Calibration Verification Relative Response Factor	J	UJ
Continuing Tune	J	X
Equipment Blank Contamination	U	
Extraction to Analysis Estimation	J-	UJ
Extraction to Analysis Rejection	J-	X
Field Blank Contamination	U	
Initial calibration Correlation Coefficient	J	UJ
Initial Calibration Percent Relative Standard Deviation	J	UJ
Initial Calibration Relative Response Factor	J	UJ
Initial Calibration Verification Percent Difference Lower Estimation	J-	UJ
Initial Calibration Verification Percent Difference Lower Rejection	J-	X
Initial Calibration Verification Percent Difference Upper Estimation	J+	
Initial Calibration Verification Percent Difference Upper Rejection	J+	No qual
Initial Calibration Verification Relative Response Factor	J	UJ
Initial Tune	J	X
Internal Standard Estimation	J	UJ
Internal Standard Rejection	J	X
Laboratory Control Precision	J	UJ
Laboratory Control Spike Lower Estimation	J-	UJ
Laboratory Control Spike Lower Rejection	J-	X
Laboratory Control Spike Upper Estimation	J+	
Laboratory Control Spike Upper Rejection	J+	No qual
Laboratory Duplicate Precision	J	UJ
Matrix Spike Lower Estimation	J-	UJ
Matrix Spike Lower Rejection	J-	X
Matrix Spike Precision	J	UJ
Matrix Spike Upper Estimation	J+	
Matrix Spike Upper Rejection	J+	No qual
Method Blank Contamination	U	
Preservation	J-	UJ
Sampling to Analysis Estimation	J-	UJ
Sampling to Analysis Rejection	J-	X
Sampling to Extraction Estimation	J-	UJ
Sampling to Extraction Rejection	J-	X
Sampling to Leaching Estimation	J-	UJ
Sampling to Leaching Rejection	J-	X
Surrogate Recovery Lower Estimation	J-	UJ
Surrogate Recovery Lower Rejection	J-	X
Surrogate Recovery Upper Estimation	J+	
Surrogate Recovery Upper Rejection	J+	No qual
Temperature Estimation	J-	UJ
Temperature Rejection	J-	X
Trip Blank Contamination	U	

Description	Metals	
	Detect Qualifier	Non-detect Qualifier
Calibration Blank Contamination	U	
Continuing Calibration Verification Percent Recovery Lower Estimation	J-	UJ
Continuing Calibration Verification Percent Recovery Lower Rejection	J-	X
Continuing Calibration Verification Percent Recovery Upper Estimation	J+	
Continuing Calibration Verification Percent Recovery Upper Rejection	X	No qual
Equipment Blank Contamination	U	
Extraction to Analysis Estimation	J-	UJ
Extraction to Analysis Rejection	J-	X
Field Blank Contamination	U	
Initial Calibration Relative Response Factor	J	UJ
Initial Calibration Verification Percent Recovery Lower Estimation	J-	UJ
Initial Calibration Verification Percent Recovery Lower Rejection	J-	X
Initial Calibration Verification Percent Recovery Upper Estimation	J+	
Initial Calibration Verification Percent Recovery Upper Rejection	X	No qual
Laboratory Control Precision	J	UJ
Laboratory Control Spike Lower Estimation	J-	UJ
Laboratory Control Spike Lower Rejection	J-	X
Laboratory Control Spike Upper Estimation	J+	
Laboratory Control Spike Upper Rejection	J+	No qual
Laboratory Duplicate Precision	J	UJ
Matrix Spike Lower Estimation	J-	UJ
Matrix Spike Lower Rejection	J-	X
Matrix Spike Precision	J	UJ
Matrix Spike Upper Estimation	J+	
Matrix Spike Upper Rejection	J+	
Method Blank Contamination	U	
Sampling to Analysis Estimation	J-	UJ
Sampling to Analysis Rejection	J-	X
Sampling to Extraction Estimation	J-	UJ
Sampling to Extraction Rejection	J-	X
Sampling to Leaching Estimation	J-	UJ
Sampling to Leaching Rejection	J-	X
Trip Blank Contamination	U	

Description	GenChem	
	Detect Qualifier	Non-detect Qualifier
Calibration Blank Contamination	U	
Continuing Calibration Verification Percent Recovery Lower Estimation	J-	UJ
Continuing Calibration Verification Percent Recovery Lower Rejection	J-	X
Continuing Calibration Verification Percent Recovery Upper Estimation	J+	
Continuing Calibration Verification Percent Recovery Upper Rejection	X	
Equipment Blank Contamination	U	
Extraction to Analysis Estimation	J-	UJ
Extraction to Analysis Rejection	J-	X
Field Blank Contamination	U	
Initial Calibration Relative Response Factor	J	UJ
Initial Calibration Verification Percent Recovery Lower Estimation	J-	UJ
Initial Calibration Verification Percent Recovery Lower Rejection	X J-	X
Initial Calibration Verification Percent Recovery Upper Estimation	J+	
Initial Calibration Verification Percent Recovery Upper Rejection	X	
Laboratory Control Precision	J	UJ
Laboratory Control Spike Lower Estimation	J-	UJ
Laboratory Control Spike Lower Rejection	J-	X
Laboratory Control Spike Upper Estimation	J+	
Laboratory Control Spike Upper Rejection	J+	X
Laboratory Duplicate Precision	J	UJ
Matrix Spike Lower Estimation	J-	UJ
Matrix Spike Lower Rejection	J-	X
Matrix Spike Precision	J	UJ
Matrix Spike Upper Estimation	J+	
Matrix Spike Upper Rejection	J+	X
Method Blank Contamination	U	
Sampling to Analysis Estimation	J-	UJ
Sampling to Analysis Rejection	J-	X
Sampling to Extraction Estimation	J-	UJ
Sampling to Extraction Rejection	J-	X
Sampling to Leaching Estimation	J-	UJ
Sampling to Leaching Rejection	J-	X
Trip Blank Contamination	U	

ATTACHMENT E

Analytical Laboratory Certifications



CERTIFICATE OF ACCREDITATION

ANSI National Accreditation Board

11617 Coldwater Road, Fort Wayne, IN 46845 USA

This is to certify that

SGS North America Inc. - Orlando

4405 Vineland Road, Suite C-15

Orlando, FL 32811

has been assessed by ANAB and meets the requirements of international standard

ISO/IEC 17025:2017

and the

U.S. Department of Defense (DoD) Quality Systems Manual for Environmental Laboratories (DoD QSM V 5.3)

while demonstrating technical competence in the field of

TESTING

Refer to the accompanying Scope of Accreditation for information regarding the types of activities to which this accreditation applies

L2229

Certificate Number



ANAB Approval

Certificate Valid Through: 12/15/2021
Version No. 005 Issued: 01/17/2020



This laboratory is accredited in accordance with the recognized International Standard ISO/IEC 17025:2017. This accreditation demonstrates technical competence for a defined scope and the operation of a laboratory quality management system (refer to joint ISO-ILAC-IAF Communiqué dated April 2017).



ANSI National Accreditation Board

SCOPE OF ACCREDITATION TO ISO/IEC 17025:2017 AND U.S. DEPARTMENT OF DEFENSE (DOD) QUALITY SYSTEMS MANUAL FOR ENVIRONMENTAL LABORATORIES (DOD QSM V 5.3)

SGS North America Inc. - Orlando

4405 Vineland Road, Suite C-15
Orlando, FL 32811
Svetlana Izosimova, Ph. D., QA Officer
407-425-6700

TESTING

Valid to: December 15, 2021

Certificate Number: L2229

Environmental

Table with 3 columns: Technology, Method, and Analyte. The table lists various LC/MS/MS methods (EPA 537 rev. 1.1 and EPA 537.1) and their corresponding analytes, including perfluorinated acids and sulfonamidoacetic acids.





Drinking Water		
Technology	Method	Analyte
LC/MS/MS	EPA 537.1	Perfluorononanoic Acid
LC/MS/MS	EPA 537.1	Perfluorodecanoic Acid
LC/MS/MS	EPA 537.1	Perfluoroundecanoic Acid
LC/MS/MS	EPA 537.1	Perfluorododecanoic Acid
LC/MS/MS	EPA 537.1	Perfluorotridecanoic Acid
LC/MS/MS	EPA 537.1	Perfluorotetradecanoic Acid
LC/MS/MS	EPA 537.1	Perfluorobutanesulfonic Acid
LC/MS/MS	EPA 537.1	Perfluorohexanesulfonic Acid
LC/MS/MS	EPA 537.1	Perfluorooctanesulfonic Acid
LC/MS/MS	EPA 537.1	N-Methyl perfluorooctanesulfonamidoacetic acid
LC/MS/MS	EPA 537.1	N-Ethyl perfluorooctanesulfonamidoacetic acid
LC/MS/MS	EPA 537.1	ADONA
LC/MS/MS	EPA 537.1	2,3,3,3-Tetrafluoro-2-(heptafluoropropoxy)propanoic acid (HFPO-DA; GenX)
LC/MS/MS	EPA 537.1	11-Chloroeicosafluoro-3-oxaundecane-1-sulfonic acid (11Cl-PF3OUdS; F53B minor)
LC/MS/MS	EPA 537.1	9-Chlorohexadecafluoro-3-oxanone-1-sulfonic acid (9Cl-PF3ONS; F53B major)

Non-Potable Water		
Technology	Method	Analyte
GC/ECD	EPA 8011	1,2-Dibromoethane (EDB)
GC/ECD	EPA 8011	1,2-Dibromo-3-Chloropropane (DBCP)
GC/ECD	EPA 504.1	1,2-Dibromoethane (EDB)
GC/ECD	EPA 504.1	1,2-Dibromo-3-Chloropropane (DBCP)
GC/ECD	EPA 504.1	1,2,3-Trichloropropane (1,2,3-TCP)
GC/FID	EPA 8015C/D	Diesel range organics (DRO)
GC/FID	EPA 8015C/D	Oil Range Organics (ORO)
GC/FID	EPA 8015C/D	Gasoline range organics (GRO)
GC/FID	EPA 8015C/D	Ethanol
GC/FID	EPA 8015C/D	2-Ethoxyethanol



Non-Potable Water		
Technology	Method	Analyte
GC/FID	EPA 8015C/D	Isobutyl alcohol (2-Methyl-1-propanol)
GC/FID	EPA 8015C/D	Isopropyl alcohol (2-Propanol)
GC/FID	EPA 8015C/D	Methanol
GC/FID	EPA 8015C/D	n-Butyl alcohol
GC/FID	EPA 8015C/D	n-Propanol
GC/ECD	EPA 608.3; EPA 8081B	4,4`-DDD
GC/ECD	EPA 608.3; EPA 8081B	4,4`-DDE
GC/ECD	EPA 608.3; EPA 8081B	4,4`-DDT
GC/ECD	EPA 608.3; EPA 8081B	Aldrin
GC/ECD	EPA 608.3; EPA 8081B	alpha-BHC (alpha-Hexachlorocyclohexane)
GC/ECD	EPA 608.3; EPA 8081B	beta-BHC (beta-Hexachlorocyclohexane)
GC/ECD	EPA 608.3; EPA 8081B	delta-BHC
GC/ECD	EPA 608.3; EPA 8081B	gamma-BHC (Lindane gamma-Hexachlorocyclohexane)
GC/ECD	EPA 608.3; EPA 8081B	Chlordane (tech.)
GC/ECD	EPA 608.3; EPA 8081B	alpha-Chlordane
GC/ECD	EPA 608.3; EPA 8081B	gamma-Chlordane
GC/ECD	EPA 608.3; EPA 8081B	Dieldrin
GC/ECD	EPA 608.3; EPA 8081B	Endosulfan I
GC/ECD	EPA 608.3; EPA 8081B	Endosulfan II
GC/ECD	EPA 608.3; EPA 8081B	Endosulfan sulfate
GC/ECD	EPA 608.3; EPA 8081B	Endrin
GC/ECD	EPA 608.3; EPA 8081B	Endrin aldehyde
GC/ECD	EPA 608.3; EPA 8081B	Endrin ketone
GC/ECD	EPA 608.3; EPA 8081B	Heptachlor
GC/ECD	EPA 608.3; EPA 8081B	Heptachlor epoxide
GC/ECD	EPA 608.3; EPA 8081B	Methoxychlor
GC/ECD	EPA 608.3; EPA 8081B	Toxaphene (Chlorinated camphene)
GC/ECD	EPA 608.3; EPA 8081B	Aroclor-1016 (PCB-1016)
GC/ECD	EPA 608.3; EPA 8081B	Aroclor-1221 (PCB-1221)
GC/ECD	EPA 608.3; EPA 8081B	Aroclor-1232 (PCB-1232)
GC/ECD	EPA 608.3; EPA 8081B	Aroclor-1242 (PCB-1242)
GC/ECD	EPA 608.3; EPA 8081B	Aroclor-1248 (PCB-1248)
GC/ECD	EPA 608.3; EPA 8081B	Aroclor-1254 (PCB-1254)
GC/ECD	EPA 608.3; EPA 8081B	Aroclor-1260 (PCB-1260)
GC/ECD	EPA 8082A	Aroclor-1262 (PCB-1262)
GC/ECD	EPA 8082A	Aroclor-1268 (PCB-1268)



Non-Potable Water		
Technology	Method	Analyte
GC/ECD	EPA 8082A	Total PCB
GC/FPD	EPA 8141B	Azinphos-methyl (Guthion)
GC/FPD	EPA 8141B	Bolstar (Sulprofos)
GC/FPD	EPA 8141B	Carbophenothion
GC/FPD	EPA 8141B	Chlorpyrifos
GC/FPD	EPA 8141B	Coumaphos
GC/FPD	EPA 8141B	Demeton-o
GC/FPD	EPA 8141B	Demeton-s
GC/FPD	EPA 8141B	Demeton
GC/FPD	EPA 8141B	Diazinon
GC/FPD	EPA 8141B	Dichlorovos (DDVP Dichlorvos)
GC/FPD	EPA 8141B	Dimethoate
GC/FPD	EPA 8141B	Disulfoton
GC/FPD	EPA 8141B	EPN
GC/FPD	EPA 8141B	Ethion
GC/FPD	EPA 8141B	Ethoprop
GC/FPD	EPA 8141B	Famphur
GC/FPD	EPA 8141B	Fensulfothion
GC/FPD	EPA 8141B	Fenthion
GC/FPD	EPA 8141B	Malathion
GC/FPD	EPA 8141B	Merphos
GC/FPD	EPA 8141B	Methyl parathion (Parathion methyl)
GC/FPD	EPA 8141B	Mevinphos
GC/FPD	EPA 8141B	Monocrotophos
GC/FPD	EPA 8141B	Naled
GC/FPD	EPA 8141B	Parathion ethyl
GC/FPD	EPA 8141B	Phorate
GC/FPD	EPA 8141B	Ronnel
GC/FPD	EPA 8141B	Stirofos
GC/FPD	EPA 8141B	Sulfotepp
GC/FPD	EPA 8141B	Tetraethyl pyrophosphate (TEPP)
GC/FPD	EPA 8141B	Thionazin (Zinophos)
GC/FPD	EPA 8141B	Tokuthion (Prothiophos)
GC/FPD	EPA 8141B	Trichloronate
GC/FPD	EPA 8141B	O,O,O-Triethyl phosphorothioate
GC/ECD	EPA 8151A	2,4,5-T
GC/ECD	EPA 8151A	2,4-D



Non-Potable Water		
Technology	Method	Analyte
GC/ECD	EPA 8151A	2,4-DB
GC/ECD	EPA 8151A	Dalapon
GC/ECD	EPA 8151A	Dicamba
GC/ECD	EPA 8151A	Dichloroprop (Dichlorprop)
GC/ECD	EPA 8151A	Dinoseb (2-sec-butyl-4,6-dinitrophenol DNBP)
GC/ECD	EPA 8151A	MCPA
GC/ECD	EPA 8151A	MCPP
GC/ECD	EPA 8151A	Pentachlorophenol
GC/ECD	EPA 8151A	Silvex (2,4,5-TP)
GC/FID	RSK-175	Acetylene
GC/FID	RSK-175	Methane
GC/FID	RSK-175	Ethane
GC/FID	RSK-175	Ethene
GC/FID	RSK-175	Propane
GC/FID	FL-PRO	Total Petroleum Hydrocarbons (TPH)
GC/FID	MA-VPH	Volatile petroleum range organics (VPH)
GC/FID	MA-EPH	Extractable petroleum range organics (EPH)
GC/FID	IA-OA1	Gasoline range organics (GRO)
GC/FID	IA-OA2	Diesel range organics (DRO)
GC/FID	TN-GRO	Gasoline range organics (GRO)
GC/FID	TN-EPH	Extractable petroleum range organics (EPH)
GC/FID	WI-DRO	Diesel range organics (DRO)
GC/FID	AK-101	Gasoline range organics (GRO)
GC/FID	AK-102	Diesel range organics (DRO)
GC/FID	OK-GRO	Gasoline range organics (GRO)
GC/FID	OK-DRO	Diesel range organics (DRO)
GC/FID	KS LRH	Low-Range Hydrocarbons (LRH)
GC/FID	KS MRH	Mid-Range Hydrocarbons (MRH)
GC/FID	KS HRH	High-Range Hydrocarbons (HRH)
GC/MS	EPA 624.1; SM 6200B-11; EPA 8260B/C/D	1,1,1,2-Tetrachloroethane
GC/MS	EPA 624.1; SM 6200B-11; EPA 8260B/C/D	1,1,1-Trichloroethane
GC/MS	EPA 624.1; SM 6200B-11; EPA 8260B/C/D	1,1,2,2-Tetrachloroethane



Non-Potable Water		
Technology	Method	Analyte
GC/MS	EPA 624.1; SM 6200B-11; EPA 8260B/C/D	1,1,2-Trichloroethane
GC/MS	EPA 624.1; SM 6200B-11; EPA 8260B/C/D	1,1-Dichloroethane
GC/MS	EPA 624.1; SM 6200B-11; EPA 8260B/C/D	1,1-Dichloroethylene
GC/MS	EPA 624.1; SM 6200B-11; EPA 8260B/C/D	1,1-Dichloropropene
GC/MS	EPA 624.1; EPA 8260B/C/D	1,1,2-Trichloro-1,2,2-trifluoroethane (Freon 113)
GC/MS	EPA 624.1; SM 6200B-11; EPA 8260B/C/D	1,2,3-Trichlorobenzene
GC/MS	EPA 624.1; SM 6200B-11; EPA 8260B/C/D	1,2,3-Trichloropropane
GC/MS	EPA 624.1; SM 6200B-11; EPA 8260B/C/D	1,2,4-Trichlorobenzene
GC/MS	EPA 624.1; SM 6200B-11; EPA 8260B/C/D	1,2,4-Trimethylbenzene
GC/MS	EPA 624.1; SM 6200B-11; EPA 8260B/C/D	1,2-Dibromo-3-chloropropane (DBCP)
GC/MS	EPA 624.1; SM 6200B-11; EPA 8260B/C/D	1,2-Dibromoethane (EDB Ethylene dibromide)
GC/MS	EPA 624.1; SM 6200B-11; EPA 8260B/C/D	1,2-Dichlorobenzene (o-Dichlorobenzene)
GC/MS	EPA 624.1; SM 6200B-11; EPA 8260B/C/D	1,2-Dichloroethane
GC/MS	EPA 624.1; SM 6200B-11; EPA 8260B/C/D	1,2-Dichloroethene (total)
GC/MS	EPA 624.1; SM 6200B-11; EPA 8260B/C/D	1,2-Dichloropropane
GC/MS	EPA 8260B/C/D	1,2-Dichlorotrifluoroethane (Freon 123)
GC/MS	EPA 624.1; SM 6200B-11; EPA 8260B/C/D	1,3,5-Trimethylbenzene
GC/MS	EPA 624.1; SM 6200B-11; EPA 8260B/C/D	1,3-Dichlorobenzene (m-Dichlorobenzene)
GC/MS	EPA 624.1; SM 6200B-11; EPA 8260B/C/D	1,3-Dichloropropane
GC/MS	EPA 624.1; SM 6200B-11; EPA 8260B/C/D	1,4-Dichlorobenzene (p-Dichlorobenzene)
GC/MS	EPA 8260B/C	1-Chlorohexane
GC/MS	EPA 624.1; SM 6200B-11; EPA 8260B/C/D	2,2-Dichloropropane



Non-Potable Water		
Technology	Method	Analyte
GC/MS	EPA 624.1; SM 6200B-11; EPA 8260B/C/D	2-Butanone (Methyl ethyl ketone MEK)
GC/MS	EPA 624.1; EPA 8260B/C/D	2-Chloroethyl vinyl ether
GC/MS	EPA 624.1; SM 6200B-11; EPA 8260B/C/D	2-Chlorotoluene
GC/MS	EPA 624.1; SM 6200B-11; EPA 8260B/C/D	2-Hexanone
GC/MS	EPA 8260B/C	2-Nitropropane
GC/MS	EPA 624.1; SM 6200B-11; EPA 8260B/C/D	4-Chlorotoluene
GC/MS	EPA 624.1; SM 6200B-11; EPA 8260B/C/D	4-Methyl-2-pentanone (MIBK)
GC/MS	EPA 624.1; SM 6200B-11; EPA 8260B/C/D	Acetone
GC/MS	EPA 8260B/C/D	Acetonitrile
GC/MS	EPA 624.1; EPA 8260B/C/D	Acrolein (Propenal)
GC/MS	EPA 624.1; EPA 8260B/C/D	Acrylonitrile
GC/MS	EPA 8260B/C/D	Allyl chloride (3-Chloropropene)
GC/MS	EPA 624.1; SM 6200B-11; EPA 8260B/C/D	Benzene
GC/MS	EPA 8260B/C/D	Benzyl Chloride
GC/MS	EPA 624.1; SM 6200B-11; EPA 8260B/C/D	Bromobenzene
GC/MS	EPA 624.1; SM 6200B-11; EPA 8260B/C/D	Bromochloromethane
GC/MS	EPA 624.1; SM 6200B-11; EPA 8260B/C/D	Bromodichloromethane
GC/MS	EPA 624.1; SM 6200B-11; EPA 8260B/C/D	Bromoform
GC/MS	EPA 624.1; SM 6200B-11; EPA 8260B/C/D	n-Butylbenzene
GC/MS	EPA 624.1; SM 6200B-11; EPA 8260B/C/D	sec-Butylbenzene
GC/MS	EPA 624.1; SM 6200B-11; EPA 8260B/C/D	tert-Butylbenzene
GC/MS	EPA 624.1; SM 6200B-11; EPA 8260B/C/D	Carbon disulfide
GC/MS	EPA 624.1; SM 6200B-11; EPA 8260B/C/D	Carbon tetrachloride
GC/MS	EPA 624.1; SM 6200B-11; EPA 8260B/C/D	Chlorobenzene



Non-Potable Water		
Technology	Method	Analyte
GC/MS	EPA 624.1; SM 6200B-11; EPA 8260B/C/D	Chloroethane
GC/MS	EPA 624.1; SM 6200B-11; EPA 8260B/C/D	Chloroform
GC/MS	EPA 8260B/C/D	Chloroprene
GC/MS	EPA 624.1; EPA 8260B/C/D	Cyclohexane
GC/MS	EPA 8260B/C/D	Cyclohexanone
GC/MS	EPA 624.1; SM 6200B-11; EPA 8260B/C/D	cis-1,2-Dichloroethylene
GC/MS	EPA 624.1; SM 6200B-11; EPA 8260B/C/D	trans-1,2-Dichloroethylene
GC/MS	EPA 624.1; SM 6200B-11; EPA 8260B/C/D	cis-1,3-Dichloropropene
GC/MS	EPA 624.1; SM 6200B-11; EPA 8260B/C/D	trans-1,3-Dichloropropylene
GC/MS	EPA 8260B/C/D	cis-1,4-Dichloro-2-butene
GC/MS	EPA 8260B/C/D	trans-1,4-Dichloro-2-butene
GC/MS	EPA 624.1; SM 6200B-11; EPA 8260B/C/D	Di-isopropylether (DIPE)
GC/MS	EPA 624.1; SM 6200B-11; EPA 8260B/C/D	Dibromochloromethane
GC/MS	EPA 624.1; SM 6200B-11; EPA 8260B/C/D	Dibromomethane (Methylene Bromide)
GC/MS	EPA 624.1; SM 6200B-11; EPA 8260B/C/D	Dichlorodifluoromethane
GC/MS	EPA 8260B/C/D	Diethyl ether
GC/MS	EPA 624.1; SM 6200B-11; EPA 8260B/C/D SIM	p-Dioxane (1,4-Dioxane)
GC/MS	EPA 624.1; SM 6200B-11; EPA 8260B/C/D	Ethanol (Ethyl Alcohol)
GC/MS	EPA 8260B/C/D	Ethyl acetate
GC/MS	EPA 8260B/C/D	Ethyl methacrylate
GC/MS	EPA 8260B/C	Ethyl tert-butyl alcohol (ETBA)
GC/MS	EPA 624.1; SM 6200B-11; EPA 8260B/C/D	Ethyl tert-butyl ether (ETBE)
GC/MS	EPA 624.1; SM 6200B-11; EPA 8260B/C/D	Ethylbenzene
GC/MS	EPA 624.1; SM 6200B-11; EPA 8260B/C/D	Hexachlorobutadiene
GC/MS	EPA 8260B/C/D	Hexane
GC/MS	EPA 8260B/C/D	Iodomethane (Methyl iodide)
GC/MS	EPA 8260B/C/D	Isobutyl alcohol (2-Methyl-1-propanol)



Non-Potable Water		
Technology	Method	Analyte
GC/MS	EPA 624.1; SM 6200B-11; EPA 8260B/C/D	p-Isopropyltoluene
GC/MS	EPA 624.1; SM 6200B-11; EPA 8260B/C/D	Isopropylbenzene
GC/MS	EPA 8260B/C/D	Methacrylonitrile
GC/MS	EPA 624.1; EPA 8260B/C/D	Methyl Acetate
GC/MS	EPA 624.1; SM 6200B-11; EPA 8260B/C/D	Methyl bromide (Bromomethane)
GC/MS	EPA 624.1; SM 6200B-11; EPA 8260B/C/D	Methyl chloride (Chloromethane)
GC/MS	EPA 624.1; EPA 8260B/C/D	Methylcyclohexane
GC/MS	EPA 8260B/C/D	Methyl methacrylate
GC/MS	EPA 624.1; SM 6200B-11; EPA 8260B/C/D	Methyl tert-butyl ether (MTBE)
GC/MS	EPA 624.1; SM 6200B-11; EPA 8260B/C/D	Methylene chloride
GC/MS	EPA 624.1; SM 6200B-11; EPA 8260B/C/D	Naphthalene
GC/MS	EPA 8260B/C/D	Pentachloroethane
GC/MS	EPA 8260B/C/D	Propionitrile (Ethyl cyanide)
GC/MS	EPA 624.1; SM 6200B-11; EPA 8260B/C/D	n-Propylbenzene
GC/MS	EPA 624.1; SM 6200B-11; EPA 8260B/C/D	Styrene
GC/MS	EPA 624.1; SM 6200B-11; EPA 8260B/C/D	tert-Amyl alcohol (TAA)
GC/MS	EPA 624.1; SM 6200B-11; EPA 8260B/C/D	tert-Amyl methyl ether (TAME)
GC/MS	EPA 624.1; SM 6200B-11; EPA 8260B/C/D	tert-Butyl alcohol (TBA)
GC/MS	EPA 624.1; SM 6200B-11; EPA 8260B/C/D	tert-Butyl formate (TBF)
GC/MS	EPA 624.1; SM 6200B-11; EPA 8260B/C/D	Tetrachloroethylene (Perchloroethylene)
GC/MS	EPA 8260B/C/D	Tetrahydrofuran
GC/MS	EPA 624.1; SM 6200B-11; EPA 8260B/C/D	Toluene
GC/MS	EPA 624.1; SM 6200B-11; EPA 8260B/C/D	Trichloroethene (Trichloroethylene)
GC/MS	EPA 624.1; SM 6200B-11; EPA 8260B/C/D	Trichlorofluoromethane



Non-Potable Water		
Technology	Method	Analyte
GC/MS	EPA 624.1; SM 6200B-11; EPA 8260B/C/D	Vinyl acetate
GC/MS	EPA 624.1; SM 6200B-11; EPA 8260B/C/D	Vinyl chloride
GC/MS	EPA 624.1; SM 6200B-11; EPA 8260B/C/D	Xylene (total)
GC/MS	EPA 624.1; SM 6200B-11; EPA 8260B/C/D	m,p-Xylene
GC/MS	EPA 624.1; SM 6200B-11; EPA 8260B/C/D	o-Xylene
GC/MS	EPA 8260B/C/D	1-Bromopropane
GC/MS	EPA 8260B/C/D	Isopropyl Alcohol
GC/MS	EPA 8260B/C/D	n-Butyl Alcohol
GC/MS	EPA 625.1; EPA 8270D/E	1,2,4,5-Tetrachlorobenzene
GC/MS	EPA 625.1; EPA 8270D/E	1,2,4-Trichlorobenzene
GC/MS	EPA 625.1; EPA 8270D/E	1,2-Dichlorobenzene (o-Dichlorobenzene)
GC/MS	EPA 625.1; EPA 8270D/E	1,2-Diphenylhydrazine
GC/MS	EPA 8270D/E	1,3,5-Trinitrobenzene (1,3,5-TNB)
GC/MS	EPA 625.1; EPA 8270D/E	1,3-Dichlorobenzene (m-Dichlorobenzene)
GC/MS	EPA 8270D/E	1,3-Dinitrobenzene (1,3-DNB)
GC/MS	EPA 625.1; EPA 8270D/E	1,4-Dichlorobenzene (p-Dichlorobenzene)
GC/MS	EPA 8270D/E	1,4-Naphthoquinone
GC/MS	EPA 8270D/E	1,4-Phenylenediamine
GC/MS	EPA 8270D/E	1-Chloronaphthalene
GC/MS	EPA 625.1; EPA 8270D/E; EPA 8270D/E SIM	1-Methylnaphthalene
GC/MS	EPA 8270D/E	1-Naphthylamine
GC/MS	EPA 625.1; EPA 8270D/E	2,3,4,6-Tetrachlorophenol
GC/MS	EPA 625.1; EPA 8270D/E	2,4,5-Trichlorophenol
GC/MS	EPA 625.1; EPA 8270D/E	2,4,6-Trichlorophenol
GC/MS	EPA 625.1; EPA 8270D/E	2,4-Dichlorophenol
GC/MS	EPA 625.1; EPA 8270D/E	2,4-Dimethylphenol
GC/MS	EPA 625.1; EPA 8270D/E	2,4-Dinitrophenol
GC/MS	EPA 625.1; EPA 8270D/E	2,4-Dinitrotoluene (2,4-DNT)
GC/MS	EPA 8270D/E	2,6-Dichlorophenol
GC/MS	EPA 625.1; EPA 8270D/E	2,6-Dinitrotoluene (2,6-DNT)
GC/MS	EPA 8270D/E	2-Acetylaminofluorene
GC/MS	EPA 625.1; EPA 8270D/E	2-Chloronaphthalene
GC/MS	EPA 625.1; EPA 8270D/E	2-Chlorophenol



Non-Potable Water		
Technology	Method	Analyte
GC/MS	EPA 625.1; EPA 8270D/E	2-Methyl-4,6-dinitrophenol (4,6-Dinitro-o-cresol)
GC/MS	EPA 625.1; EPA 8270D/E; EPA 8270D/E SIM	2-Methylnaphthalene
GC/MS	EPA 625.1; EPA 8270D/E	2-Methylphenol (o-Cresol)
GC/MS	EPA 8270D/E	2-Naphthylamine
GC/MS	EPA 625.1; EPA 8270D/E	2-Nitroaniline
GC/MS	EPA 625.1; EPA 8270D/E	2-Nitrophenol
GC/MS	EPA 8270D/E	2-Picoline (2-Methylpyridine)
GC/MS	EPA 625.1; EPA 8270D/E	3,3`-Dichlorobenzidine
GC/MS	EPA 8270D/E	3,3`-Dimethylbenzidine
GC/MS	EPA 8270D/E	3-Methylcholanthrene
GC/MS	EPA 625.1; EPA 8270D/E	3&4-Methylphenol (m,p-Cresol)
GC/MS	EPA 625.1; EPA 8270D/E	3-Nitroaniline
GC/MS	EPA 8270D/E	4-Aminobiphenyl
GC/MS	EPA 625.1; EPA 8270D/E	4-Bromophenyl phenyl ether
GC/MS	EPA 625.1; EPA 8270D/E	4-Chloro-3-methylphenol
GC/MS	EPA 625.1; EPA 8270D/E	4-Chloroaniline
GC/MS	EPA 625.1; EPA 8270D/E	4-Chlorophenyl phenylether
GC/MS	EPA 8270D/E	4-Dimethyl aminoazobenzene
GC/MS	EPA 625.1; EPA 8270D/E	4-Nitroaniline
GC/MS	EPA 625.1; EPA 8270D/E	4-Nitrophenol
GC/MS	EPA 8270D/E	5-Nitro-o-toluidine
GC/MS	EPA 8270D/E	7,12-Dimethylbenz(a) anthracene
GC/MS	EPA 625.1; EPA 8270D/E; EPA 8270D/E SIM	Acenaphthene
GC/MS	EPA 625.1; EPA 8270D/E; EPA 8270D/E SIM	Acenaphthylene
GC/MS	EPA 625.1; EPA 8270D/E	Acetophenone
GC/MS	EPA 625.1; EPA 8270D/E	Aniline
GC/MS	EPA 625.1; EPA 8270D/E; EPA 8270D/E SIM	Anthracene
GC/MS	EPA 8270D/E	Aramite
GC/MS	EPA 625.1; EPA 8270D/E	Atrazine
GC/MS	EPA 625.1; EPA 8270D/E	Benzaldehyde
GC/MS	EPA 625.1; EPA 8270D/E	Benzidine
GC/MS	EPA 625.1; EPA 8270D/E; EPA 8270D/E SIM	Benzo(a)anthracene



Non-Potable Water		
Technology	Method	Analyte
GC/MS	EPA 625.1; EPA 8270D/E; EPA 8270D/E SIM	Benzo(a)pyrene
GC/MS	EPA 625.1; EPA 8270D/E; EPA 8270D/E SIM	Benzo(b)fluoranthene
GC/MS	EPA 625.1; EPA 8270D/E; EPA 8270D/E SIM	Benzo(g,h,i)perylene
GC/MS	EPA 625.1; EPA 8270D/E; EPA 8270D/E SIM	Benzo(k)fluoranthene
GC/MS	EPA 625.1; EPA 8270D/E	Benzoic acid
GC/MS	EPA 625.1; EPA 8270D/E	Benzyl alcohol
GC/MS	EPA 625.1; EPA 8270D/E	Biphenyl (1,1'-Biphenyl)
GC/MS	EPA 625.1; EPA 8270D/E	bis(2-Chloroethoxy)methane
GC/MS	EPA 625.1; EPA 8270D/E	bis(2-Chloroethyl) ether
GC/MS	EPA 625.1; EPA 8270D/E	bis(2-Chloroisopropyl) ether (2,2'-Oxybis(1-chloropropane))
GC/MS	EPA 625.1; EPA 8270D/E	bis(2-Ethylhexyl) phthalate (DEHP)
GC/MS	EPA 625.1; EPA 8270D/E	Butyl benzyl phthalate
GC/MS	EPA 625.1; EPA 8270D/E	Carbazole
GC/MS	EPA 625.1; EPA 8270D/E	Caprolactam
GC/MS	EPA 8270D/E	Chlorobenzilate
GC/MS	EPA 625.1; EPA 8270D/E; EPA 8270D/E SIM	Chrysene
GC/MS	EPA 8270D/E	Diallate
GC/MS	EPA 8270D/E	Dinoseb
GC/MS	EPA 625.1; EPA 8270D/E	Di-n-butyl phthalate
GC/MS	EPA 625.1; EPA 8270D/E	Di-n-octyl phthalate
GC/MS	EPA 625.1; EPA 8270D/E; EPA 8270D/E SIM	Dibenz(a,h)anthracene
GC/MS	EPA 8270D/E	Dibenz(a,j)acridine
GC/MS	EPA 625.1; EPA 8270D/E	Dibenzofuran
GC/MS	EPA 625.1; EPA 8270D/E	Diethyl phthalate
GC/MS	EPA 625.1; EPA 8270D/E	Dimethyl phthalate
GC/MS	EPA 8270D/E	a,a-Dimethylphenethylamine
GC/MS	EPA 8270D/E	Diphenyl Ether
GC/MS	EPA 8270D/E	p-Dioxane (1,4-Dioxane)
GC/MS	EPA 8270D/E	Ethyl methanesulfonate
GC/MS	EPA 625.1; EPA 8270D/E; EPA 8270D/E SIM	Fluoranthene
GC/MS	EPA 625.1; EPA 8270D/E; EPA 8270D/E SIM	Fluorene



Non-Potable Water		
Technology	Method	Analyte
GC/MS	EPA 625.1; EPA 8270D/E	Hexachlorobenzene
GC/MS	EPA 625.1; EPA 8270D/E	Hexachlorobutadiene
GC/MS	EPA 625.1; EPA 8270D/E	Hexachlorocyclopentadiene
GC/MS	EPA 625.1; EPA 8270D/E	Hexachloroethane
GC/MS	EPA 8270D/E	Hexachlorophene
GC/MS	EPA 8270D/E	Hexachloropropene
GC/MS	EPA 625.1; EPA 8270D/E; EPA 8270D/E SIM	Indeno(1,2,3-cd)pyrene
GC/MS	EPA 8270D	Isodrin
GC/MS	EPA 625.1; EPA 8270D/E	Isophorone
GC/MS	EPA 8270D/E	Isosafrole
GC/MS	EPA 8270D/E	Kepone
GC/MS	EPA 8270D/E	Methapyrilene
GC/MS	EPA 8270D/E	Methyl methanesulfonate
GC/MS	EPA 625.1; EPA 8270D/E; EPA 8270D/E SIM	Naphthalene
GC/MS	EPA 625.1; EPA 8270D/E	Nitrobenzene
GC/MS	EPA 8270D/E	Nitroquinoline-1-oxide
GC/MS	EPA 8270D/E	n-Nitroso-di-n-butylamine
GC/MS	EPA 625.1; EPA 8270D/E	n-Nitrosodi-n-propylamine
GC/MS	EPA 8270D/E	n-Nitrosodiethylamine
GC/MS	EPA 625.1; EPA 8270D/E	n-Nitrosodimethylamine
GC/MS	EPA 625.1; EPA 8270D/E	n-Nitrosodiphenylamine
GC/MS	EPA 8270D/E	n-Nitrosodiphenylamine/Diphenylamine (analyte pair)
GC/MS	EPA 8270D/E	n-Nitrosomethylethylamine
GC/MS	EPA 8270D/E	n-Nitrosomorpholine
GC/MS	EPA 8270D/E	n-Nitrosopiperidine
GC/MS	EPA 8270D/E	n-Nitrosopyrrolidine
GC/MS	EPA 8270D/E	Pentachlorobenzene
GC/MS	EPA 8270D/E	Pentachloroethane
GC/MS	EPA 8270D/E	Pentachloronitrobenzene
GC/MS	EPA 625.1; EPA 8270D/E; EPA 8270D/E SIM	Pentachlorophenol
GC/MS	EPA 8270D/E	Phenacetin
GC/MS	EPA 625.1; EPA 8270D/E; EPA 8270D/E SIM	Phenanthrene
GC/MS	EPA 625.1; EPA 8270D/E	Phenol
GC/MS	EPA 8270D/E	Pronamide (Kerb)



Non-Potable Water		
Technology	Method	Analyte
GC/MS	EPA 625.1; EPA 8270D/E; EPA 8270D/E SIM	Pyrene
GC/MS	EPA 625.1; EPA 8270D/E	Pyridine
GC/MS	EPA 8270D/E	Safrole
GC/MS	EPA 8270D/E	Simazine
GC/MS	EPA 8270D/E	Thionazin (Zinophos)
GC/MS	EPA 8270D/E	o-Toluidine
GC/MS	EPA 8270D/E	Dimethoate
GC/MS	EPA 8270D/E	Disulfoton
GC/MS	EPA 8270D/E	Famphur
GC/MS	EPA 8270D/E	Methyl parathion (Parathion methyl)
GC/MS	EPA 8270D/E	Parathion ethyl
GC/MS	EPA 8270D/E	Phorate
GC/MS	EPA 8270D/E	O,O,O-Triethyl phosphorothioate
HPLC	EPA 610	1-Methylnaphthalene
HPLC	EPA 610	2-Methylnaphthalene
HPLC	EPA 610	Acenaphthene
HPLC	EPA 610	Acenaphthylene
HPLC	EPA 610	Anthracene
HPLC	EPA 610	Benzo(a)anthracene
HPLC	EPA 610	Benzo(a)pyrene
HPLC	EPA 610	Benzo(b)fluoranthene
HPLC	EPA 610	Benzo(g h i)perylene
HPLC	EPA 610	Benzo(k)fluoranthene
HPLC	EPA 610	Chrysene
HPLC	EPA 610	Dibenz(a,h)anthracene
HPLC	EPA 610	Fluoranthene
HPLC	EPA 610	Fluorene
HPLC	EPA 610	Indeno(1,2,3-cd)pyrene
HPLC	EPA 610	Naphthalene
HPLC	EPA 610	Phenanthrene
HPLC	EPA 610	Pyrene
HPLC	EPA 8330A/B	1,3,5-Trinitrobenzene (1,3,5-TNB)
HPLC	EPA 8330A/B	1,3-Dinitrobenzene (1,3-DNB)
HPLC	EPA 8330A/B	2,4,6-Trinitrotoluene (2,4,6-TNT)
HPLC	EPA 8330A/B	2,4-Dinitrotoluene (2,4-DNT)
HPLC	EPA 8330A/B	2,6-Dinitrotoluene (2,6-DNT)
HPLC	EPA 8330A/B	2-Amino-4,6-dinitrotoluene (2-am-dnt)



Non-Potable Water		
Technology	Method	Analyte
HPLC	EPA 8330A/B	2-Nitrotoluene
HPLC	EPA 8330A/B	3,5-Dinitroaniline
HPLC	EPA 8330A/B	3-Nitrotoluene
HPLC	EPA 8330A/B	4-Amino-2,6-dinitrotoluene (4-am-dnt)
HPLC	EPA 8330A/B	4-Nitrotoluene
HPLC	EPA 8330A/B	Hexahydro-1,3,5-trinitro-1,3,5-triazine (RDX)
HPLC	EPA 8330A/B	Nitrobenzene
HPLC	EPA 8330A/B	Nitroglycerin
HPLC	EPA 8330A/B	Methyl-2,4,6-trinitrophenylnitramine (Tetryl)
HPLC	EPA 8330A/B	Octahydro-1,3,5,7-tetranitro-1,3,5,7-tetrazocine (HMX)
HPLC	EPA 8330A/B	Pentaerythritoltetranitrate (PETN)
HPLC	EPA 8330A	2,2',6,6'-Tetranitro-4,4'-azoxytoluene
HPLC	EPA 8330A/B	2-amino-6-Nitrotoluene
HPLC	EPA 8330A/B	4-amino-2-Nitrotoluene
HPLC	EPA 8330A/B	2-amino-4-Nitrotoluene
HPLC	EPA 8330A/B	2,4-diamino-6-Nitrotoluene
HPLC	EPA 8330A/B	2,6-diamino-4-Nitrotoluene
HPLC	EPA 8330A/B	DNX
HPLC	EPA 8330A/B	MXN
HPLC	EPA 8330A/B	TNX
HPLC	EPA 8330A	Nitroguanidine
HPLC	EPA 8330A	Guanidine Nitrate
LC/MS/MS	EPA 6850	Perchlorate
LC/MS/MS	EPA 537 MOD ²	Perfluorobutanoic Acid
LC/MS/MS	EPA 537 MOD ²	Perfluoropentanoic Acid
LC/MS/MS	EPA 537 MOD ²	Perfluorohexanoic Acid
LC/MS/MS	EPA 537 MOD ²	Perfluoroheptanoic Acid
LC/MS/MS	EPA 537 MOD ²	Perfluorooctanoic Acid
LC/MS/MS	EPA 537 MOD ²	Perfluorononanoic Acid
LC/MS/MS	EPA 537 MOD ²	Perfluorodecanoic Acid
LC/MS/MS	EPA 537 MOD ²	Perfluoroundecanoic Acid
LC/MS/MS	EPA 537 MOD ²	Perfluorododecanoic Acid
LC/MS/MS	EPA 537 MOD ²	Perfluorotridecanoic Acid
LC/MS/MS	EPA 537 MOD ²	Perfluorotetradecanoic Acid
LC/MS/MS	EPA 537 MOD ²	Perfluorobutanesulfonic Acid



Non-Potable Water		
Technology	Method	Analyte
LC/MS/MS	EPA 537 MOD ²	Perfluorohexanesulfonic Acid
LC/MS/MS	EPA 537 MOD ²	Perfluorooctanesulfonic Acid
LC/MS/MS	EPA 537 MOD ²	Perfluorodecanesulfonic Acid
LC/MS/MS	EPA 537 MOD ²	Perfluorooctanesulfonic Acid
LC/MS/MS	EPA 537 MOD ²	Perfluorononanesulfonic Acid
LC/MS/MS	EPA 537 MOD ²	Perfluorodecanesulfonic Acid
LC/MS/MS	EPA 537 MOD ²	Perfluoroheptanesulfonic acid
LC/MS/MS	EPA 537 MOD ²	Perfluoropentanesulfonic Acid
LC/MS/MS	EPA 537 MOD ²	Perfluorooctane sulfonamide
LC/MS/MS	EPA 537 MOD ²	N-Methyl perfluorooctane sulfonamide
LC/MS/MS	EPA 537 MOD ²	N-Ethyl perfluorooctane sulfonamide
LC/MS/MS	EPA 537 MOD ²	Perfluoro-1-octanesulfonamidoacetic acid
LC/MS/MS	EPA 537 MOD ²	N-Methyl perfluorooctanesulfonamidoacetic acid
LC/MS/MS	EPA 537 MOD ²	N-Ethyl perfluorooctanesulfonamidoacetic acid
LC/MS/MS	EPA 537 MOD ²	N-Methyl perfluorooctane sulfonamidoethanol
LC/MS/MS	EPA 537 MOD ²	N-Ethyl perfluorooctane sulfonamidoethanol
LC/MS/MS	EPA 537 MOD ²	4:2 Fluorotelomer Sulfonate
LC/MS/MS	EPA 537 MOD ²	6:2 Fluorotelomer Sulfonate
LC/MS/MS	EPA 537 MOD ²	8:2 Fluorotelomer Sulfonate
LC/MS/MS	PFAS by LCMSMS Compliant with QSM 5.3 Table B-15	Perfluorobutanoic Acid (PFBA)
LC/MS/MS	PFAS by LCMSMS Compliant with QSM 5.3 Table B-15	Perfluoropentanoic Acid (PFPeA)
LC/MS/MS	PFAS by LCMSMS Compliant with QSM 5.3 Table B-15	Perfluorohexanoic Acid (PFHxA)
LC/MS/MS	PFAS by LCMSMS Compliant with QSM 5.3 Table B-15	Perfluoroheptanoic Acid (PFHpA)
LC/MS/MS	PFAS by LCMSMS Compliant with QSM 5.3 Table B-15	Perfluorooctanoic Acid (PFOA)
LC/MS/MS	PFAS by LCMSMS Compliant with QSM 5.3 Table B-15	Perfluorononanoic Acid (PFNA)
LC/MS/MS	PFAS by LCMSMS Compliant with QSM 5.3 Table B-15	Perfluorodecanoic Acid (PFDA)
LC/MS/MS	PFAS by LCMSMS Compliant with QSM 5.3 Table B-15	Perfluoroundecanoic Acid (PFUnA)
LC/MS/MS	PFAS by LCMSMS Compliant with QSM 5.3 Table B-15	Perfluorododecanoic Acid(PFDoA)



Non-Potable Water		
Technology	Method	Analyte
LC/MS/MS	PFAS by LCMSMS Compliant with QSM 5.3 Table B-15	Perfluorotridecanoic Acid (PFTTrDA)
LC/MS/MS	PFAS by LCMSMS Compliant with QSM 5.3 Table B-15	Perfluorotetradecanoic Acid (PFTA)
LC/MS/MS	PFAS by LCMSMS Compliant with QSM 5.3 Table B-15	Perfluorobutanesulfonic Acid (PFBS)
LC/MS/MS	PFAS by LCMSMS Compliant with QSM 5.3 Table B-15	Perfluorohexanesulfonic Acid(PFHxS)
LC/MS/MS	PFAS by LCMSMS Compliant with QSM 5.3 Table B-15	Perfluorooctanesulfonic Acid(PFOS)
LC/MS/MS	PFAS by LCMSMS Compliant with QSM 5.3 Table B-15	Perfluorononanesulfonic Acid(PFNS)
LC/MS/MS	PFAS by LCMSMS Compliant with QSM 5.3 Table B-15	Perfluorodecanesulfonic Acid(PFDS)
LC/MS/MS	PFAS by LCMSMS Compliant with QSM 5.3 Table B-15	Perfluoroheptanesulfonic acid(PFHpS)
LC/MS/MS	PFAS by LCMSMS Compliant with QSM 5.3 Table B-15	Perfluoropentanesulfonic Acid(PFPeS)
LC/MS/MS	PFAS by LCMSMS Compliant with QSM 5.3 Table B-15	Perfluorooctane sulfonamide (PFOSA)
LC/MS/MS	PFAS by LCMSMS Compliant with QSM 5.3 Table B-15	N-Methyl perfluorooctanesulfonamidoacetic acid (MeFOSAA)
LC/MS/MS	PFAS by LCMSMS Compliant with QSM 5.3 Table B-15	N-Ethyl perfluorooctanesulfonamidoacetic acid (EtFOSAA)
LC/MS/MS	PFAS by LCMSMS Compliant with QSM 5.3 Table B-15	4:2 Fluorotelomer Sulfonate (FTS 4:2)
LC/MS/MS	PFAS by LCMSMS Compliant with QSM 5.3 Table B-15	6:2 Fluorotelomer Sulfonate(FTS 6:2)
LC/MS/MS	PFAS by LCMSMS Compliant with QSM 5.3 Table B-15	8:2 Fluorotelomer Sulfonate (FTS 8:2)
LC/MS/MS	PFAS by LCMSMS Compliant with QSM 5.3 Table B-15	ADONA
LC/MS/MS	PFAS by LCMSMS Compliant with QSM 5.3 Table B-15	2,3,3,3-Tetrafluoro-2-(heptafluoropropoxy)propanoic acid (HFPO-DA; GenX)
LC/MS/MS	PFAS by LCMSMS Compliant with QSM 5.3 Table B-15	11-Chloroeicosafuoro-3-oxaundecane-1-sulfonic acid (11Cl-PF3OUdS; F53B minor)
LC/MS/MS	PFAS by LCMSMS Compliant with QSM 5.3 Table B-15	9-Chlorohexadecafluoro-3-oxanone-1-sulfonic acid (9Cl-PF3ONS; F53B major)
ICP	EPA 200.7; EPA 6010C/D	Aluminum
ICP	EPA 200.7; EPA 6010C/D	Antimony



Non-Potable Water		
Technology	Method	Analyte
ICP	EPA 200.7; EPA 6010C/D	Arsenic
ICP	EPA 200.7; EPA 6010C/D	Barium
ICP	EPA 200.7; EPA 6010C/D	Beryllium
ICP	EPA 200.7; EPA 6010C/D	Cadmium
ICP	EPA 200.7; EPA 6010C/D	Calcium
ICP	EPA 200.7; EPA 6010C/D	Chromium
ICP	EPA 200.7; EPA 6010C/D	Cobalt
ICP	EPA 200.7; EPA 6010C/D	Copper
ICP	EPA 200.7; EPA 6010C/D	Iron
ICP	EPA 200.7; EPA 6010C/D	Lead
ICP	EPA 200.7; EPA 6010C/D	Magnesium
ICP	EPA 200.7; EPA 6010C/D	Manganese
ICP	EPA 200.7; EPA 6010C/D	Molybdenum
ICP	EPA 200.7; EPA 6010C/D	Nickel
ICP	EPA 200.7; EPA 6010C/D	Potassium
ICP	EPA 200.7; EPA 6010C/D	Selenium
ICP	EPA 200.7; EPA 6010C/D	Silver
ICP	EPA 200.7; EPA 6010C/D	Sodium
ICP	EPA 200.7; EPA 6010C/D	Strontium
ICP	EPA 200.7; EPA 6010C/D	Thallium
ICP	EPA 200.7; EPA 6010C/D	Tin
ICP	EPA 200.7; EPA 6010C/D	Titanium
ICP	EPA 200.7; EPA 6010C/D	Vanadium
ICP	EPA 200.7; EPA 6010C/D	Zinc
ICP/MS	EPA 200.8; EPA 6020A/B	Aluminum
ICP/MS	EPA 200.8; EPA 6020A/B	Antimony
ICP/MS	EPA 200.8; EPA 6020A/B	Arsenic
ICP/MS	EPA 200.8; EPA 6020A/B	Barium
ICP/MS	EPA 200.8; EPA 6020A/B	Beryllium
ICP/MS	EPA 200.8; EPA 6020A/B	Cadmium
ICP/MS	EPA 200.8; EPA 6020A/B	Calcium
ICP/MS	EPA 200.8; EPA 6020A/B	Chromium
ICP/MS	EPA 200.8; EPA 6020A/B	Cobalt
ICP/MS	EPA 200.8; EPA 6020A/B	Copper
ICP/MS	EPA 200.8; EPA 6020A/B	Iron
ICP/MS	EPA 200.8; EPA 6020A/B	Lead
ICP/MS	EPA 200.8; EPA 6020A/B	Magnesium
ICP/MS	EPA 200.8; EPA 6020A/B	Manganese



Non-Potable Water		
Technology	Method	Analyte
ICP/MS	EPA 200.8; EPA 6020A/B	Molybdenum
ICP/MS	EPA 200.8; EPA 6020A/B	Nickel
ICP/MS	EPA 200.8; EPA 6020A/B	Potassium
ICP/MS	EPA 200.8; EPA 6020A/B	Selenium
ICP/MS	EPA 200.8; EPA 6020A/B	Silver
ICP/MS	EPA 200.8; EPA 6020A/B	Sodium
ICP/MS	EPA 200.8; EPA 6020A/B	Strontium
ICP/MS	EPA 200.8; EPA 6020A/B	Thallium
ICP/MS	EPA 200.8; EPA 6020A/B	Tin
ICP/MS	EPA 200.8; EPA 6020A/B	Titanium
ICP/MS	EPA 200.8; EPA 6020A/B	Vanadium
ICP/MS	EPA 200.8; EPA 6020A/B	Zinc
CVAA	EPA 7470A	Mercury
CVAA	EPA 245.1	Mercury
UV/VIS	EPA 7196A	Hexavalent Chromium (Cr6+)
UV/VIS	EPA 9012B	Cyanide (Total)
IC	EPA 300; EPA 9056A	Bromide
IC	EPA 300; EPA 9056A	Chloride
IC	EPA 300; EPA 9056A	Fluoride
IC	EPA 300; EPA 9056A	Nitrate
IC	EPA 300; EPA 9056A	Nitrite
IC	EPA 300; EPA 9056A	Sulfate
IC	EPA 300; EPA 9056A	Total nitrate-nitrite
IC	EPA 300; EPA 9056A	Orthophosphate
Automated Colorimetry	EPA 350.1	Ammonia
Automated Colorimetry	EPA 350.1	Ammonia, Gas Diffusion Option
Automated Colorimetry	EPA 351.2	Total Kjeldahl Nitrogen
Automated Colorimetry	EPA 420.4	Total Phenolics
Automated Colorimetry	EPA 353.2	Nitrate
Automated Colorimetry	EPA 353.2	Nitrite
Automated Colorimetry	EPA 353.2	Nitrate+Nitrite
Manual Colorimetry	EPA 365.3	Orthophosphate
Automated Colorimetry	EPA 365.1	Orthophosphate
Automated Colorimetry	EPA 365.1	Total Phosphorus
Manual Colorimetry	EPA 365.3	Total Phosphorus
Titrimetric	SM 2320B-11	Alkalinity, Total
Titrimetric	SM 4500-S2 F-11	Sulfide, Iodometric



Non-Potable Water		
Technology	Method	Analyte
Gravimetric Methods	EPA 1664A; EPA 1664B; EPA 9070A	Oil and Grease
Gravimetric Methods	SM 2540B-11	Total Residue (Total Solids)
Gravimetric Methods	SM 2540C-11	Filterable Residue (Total Dissolved Solids)
Gravimetric Methods	SM 2540D-11	Non-Filterable Residue (Total Suspended Solids)
Electrometric Methods	SM 4500H+B-11; EPA 9040C	Hydrogen Ion (Ph)
Electrometric Methods	EPA 120.1	Specific conductivity
Combustion	EPA 9060A	Total Organic Carbon
Combustion	SM 5310B-11	Total Organic Carbon
Ignitability	EPA 1010A	Flash Point
Ignitability	EPA 1020B/ASTM D3278-78	Flash Point
Waste Characterization	EPA Ch.7	Reactive Cyanide and Reactive Sulfide
Waste Characterization	EPA Section 7.3	Reactive Cyanide
Waste Characterization	EPA Section 7.3	Reactive Sulfide
Preparation	Method	Type
Organic Preparation	EPA 3510C	Separatory Funnel Liquid-Liquid Extraction
Organic Preparation	EPA 3511	Micro-extraction
Organic Preparation	EPA 3535A; EPA 3535A MOD	Solid Phase Extraction
Organic Preparation	EPA 8015C/D	Non-Halogenated Organics (Alcohols), direct injection
Organic Preparation	EPA 8151A	Chlorinated Herbicides, Liquid-Liquid Extraction
Organic Preparation	EPA 608; EPA 610; EPA 625	Separatory Funnel Liquid-Liquid Extraction
Volatile Organic Preparation	SW836 5030B	Closed System Purge and Trap
Volatile Organic Preparation	EPA 624	Closed System Purge and Trap
Volatile Organic Preparation	SM 6200B-11	Closed System Purge and Trap
Lachat MicroDistillation	EPA 9012B	Cyanide MicroDistillation; proprietary method
Inorganic Preparation	EPA 3010A	Metals Acid Digestion by Hotblock
Inorganic Preparation	EPA 7470A	CVAA Digestion by Hotblock
Organics Cleanup	EPA 3660B	Sulfur Cleanup
Organics Cleanup	EPA 3665A	Sulfuric Acid Cleanup



Solid and Chemical Materials		
Technology	Method	Analyte
GC/ECD	EPA 8011	1,2-Dibromoethane (EDB)
GC/ECD	EPA 8011	1,2-Dibromo-3-Chloropropane (DBCP)
GC/FID	EPA 8015C/D	Diesel range organics (DRO)
GC/FID	EPA 8015C/D	Oil Range Organics (ORO)
GC/FID	EPA 8015C/D	Gasoline range organics (GRO)
GC/FID	EPA 8015C/D	Ethanol
GC/FID	EPA 8015C/D	2-Ethoxyethanol
GC/FID	EPA 8015C/D	Isobutyl alcohol (2-Methyl-1-propanol)
GC/FID	EPA 8015C/D	Isopropyl alcohol (2-Propanol)
GC/FID	EPA 8015C/D	Methanol
GC/FID	EPA 8015C/D	n-Butyl alcohol
GC/FID	EPA 8015C/D	n-Propanol
GC/ECD	EPA 8081B	4,4`-DDD
GC/ECD	EPA 8081B	4,4`-DDE
GC/ECD	EPA 8081B	4,4`-DDT
GC/ECD	EPA 8081B	Aldrin
GC/ECD	EPA 8081B	alpha-BHC (alpha-Hexachlorocyclohexane)
GC/ECD	EPA 8081B	beta-BHC (beta-Hexachlorocyclohexane)
GC/ECD	EPA 8081B	delta-BHC
GC/ECD	EPA 8081B	gamma-BHC (Lindane gamma-Hexachlorocyclohexane)
GC/ECD	EPA 8081B	Chlordane (tech.)
GC/ECD	EPA 8081B	alpha-Chlordane
GC/ECD	EPA 8081B	gamma-Chlordane
GC/ECD	EPA 8081B	Dieldrin
GC/ECD	EPA 8081B	Endosulfan I
GC/ECD	EPA 8081B	Endosulfan II
GC/ECD	EPA 8081B	Endosulfan sulfate
GC/ECD	EPA 8081B	Endrin
GC/ECD	EPA 8081B	Endrin aldehyde
GC/ECD	EPA 8081B	Endrin ketone
GC/ECD	EPA 8081B	Heptachlor
GC/ECD	EPA 8081B	Heptachlor epoxide
GC/ECD	EPA 8081B	Methoxychlor
GC/ECD	EPA 8081B	Toxaphene (Chlorinated camphene)
GC/ECD	EPA 8082A	Aroclor-1016 (PCB-1016)
GC/ECD	EPA 8082A	Aroclor-1221 (PCB-1221)



Solid and Chemical Materials		
Technology	Method	Analyte
GC/ECD	EPA 8082A	Aroclor-1232 (PCB-1232)
GC/ECD	EPA 8082A	Aroclor-1242 (PCB-1242)
GC/ECD	EPA 8082A	Aroclor-1248 (PCB-1248)
GC/ECD	EPA 8082A	Aroclor-1254 (PCB-1254)
GC/ECD	EPA 8082A	Aroclor-1260 (PCB-1260)
GC/ECD	EPA 8082A	Aroclor-1262 (PCB-1262)
GC/ECD	EPA 8082A	Aroclor-1268 (PCB-1268)
GC/ECD	EPA 8082A	Total PCB
GC/FPD	EPA 8141B	Azinphos-methyl (Guthion)
GC/FPD	EPA 8141B	Bolstar (Sulprofos)
GC/FPD	EPA 8141B	Carbophenothion
GC/FPD	EPA 8141B	Chlorpyrifos
GC/FPD	EPA 8141B	Coumaphos
GC/FPD	EPA 8141B	Demeton-o
GC/FPD	EPA 8141B	Demeton-s
GC/FPD	EPA 8141B	Demeton
GC/FPD	EPA 8141B	Diazinon
GC/FPD	EPA 8141B	Dichlorovos (DDVP Dichlorvos)
GC/FPD	EPA 8141B	Dimethoate
GC/FPD	EPA 8141B	Disulfoton
GC/FPD	EPA 8141B	EPN
GC/FPD	EPA 8141B	Ethion
GC/FPD	EPA 8141B	Ethoprop
GC/FPD	EPA 8141B	Famphur
GC/FPD	EPA 8141B	Fensulfothion
GC/FPD	EPA 8141B	Fenthion
GC/FPD	EPA 8141B	Malathion
GC/FPD	EPA 8141B	Merphos
GC/FPD	EPA 8141B	Methyl parathion (Parathion methyl)
GC/FPD	EPA 8141B	Mevinphos
GC/FPD	EPA 8141B	Monocrotophos
GC/FPD	EPA 8141B	Naled
GC/FPD	EPA 8141B	Parathion ethyl
GC/FPD	EPA 8141B	Phorate
GC/FPD	EPA 8141B	Ronnel
GC/FPD	EPA 8141B	Stirofos
GC/FPD	EPA 8141B	Sulfotepp





Solid and Chemical Materials		
Technology	Method	Analyte
GC/FPD	EPA 8141B	Tetraethyl pyrophosphate (TEPP)
GC/FPD	EPA 8141B	Thionazin (Zinophos)
GC/FPD	EPA 8141B	Tokuthion (Prothiophos)
GC/FPD	EPA 8141B	Trichloronate
GC/FPD	EPA 8141B	O,O,O-Triethyl phosphorothioate
GC/ECD	EPA 8151A	2,4,5-T
GC/ECD	EPA 8151A	2,4-D
GC/ECD	EPA 8151A	2,4-DB
GC/ECD	EPA 8151A	Dalapon
GC/ECD	EPA 8151A	Dicamba
GC/ECD	EPA 8151A	Dichloroprop (Dichlorprop)
GC/ECD	EPA 8151A	Dinoseb (2-sec-butyl-4,6-dinitrophenol DNBP)
GC/ECD	EPA 8151A	MCPA
GC/ECD	EPA 8151A	MCPP
GC/ECD	EPA 8151A	Pentachlorophenol
GC/ECD	EPA 8151A	Silvex (2,4,5-TP)
GC/FID	FL-PRO	Total Petroleum Hydrocarbons (TPH)
GC/FID	MA-VPH	Volatile petroleum range organics (VPH)
GC/FID	MA-EPH	Extractable petroleum range organics (EPH)
GC/FID	IA-OA1	Gasoline range organics (GRO)
GC/FID	IA-OA2	Diesel range organics (DRO)
GC/FID	TN-GRO	Gasoline range organics (GRO)
GC/FID	TN-EPH	Extractable petroleum range organics (EPH)
GC/FID	AK-101	Gasoline range organics (GRO)
GC/FID	AK-102	Diesel range organics (DRO)
GC/FID	AK-103	Residual range organics (RRO)
GC/FID	OK-GRO	Gasoline range organics (GRO)
GC/FID	OK-DRO	Diesel range organics (DRO)
GC/FID	KS LRH	Low-range Hydrocarbons (LRH)
GC/FID	KS MRH	Mid-Range Hydrocarbons (MRH)
GC/FID	KS HRH	High-Range Hydrocarbons (HRH)
GC/MS	EPA 8260B/C/D	1,1,1,2-Tetrachloroethane
GC/MS	EPA 8260B/C/D	1,1,1-Trichloroethane
GC/MS	EPA 8260B/C/D	1,1,2,2-Tetrachloroethane
GC/MS	EPA 8260B/C/D	1,1,2-Trichloroethane



Solid and Chemical Materials		
Technology	Method	Analyte
GC/MS	EPA 8260B/C/D	1,1-Dichloroethane
GC/MS	EPA 8260B/C/D	1,1-Dichloroethylene
GC/MS	EPA 8260B/C/D	1,1-Dichloropropene
GC/MS	EPA 8260B/C/D	1,1,2-Trichloro-1,2,2-trifluoroethane (Freon 113)
GC/MS	EPA 8260B/C/D	1,2,3-Trichlorobenzene
GC/MS	EPA 8260B/C/D	1,2,3-Trichloropropane
GC/MS	EPA 8260B/C/D	1,2,4-Trichlorobenzene
GC/MS	EPA 8260B/C/D	1,2,4-Trimethylbenzene
GC/MS	EPA 8260B/C/D	1,2-Dibromo-3-chloropropane (DBCP)
GC/MS	EPA 8260B/C/D	1,2-Dibromoethane (EDB Ethylene dibromide)
GC/MS	EPA 8260B/C/D	1,2-Dichlorobenzene (o-Dichlorobenzene)
GC/MS	EPA 8260B/C/D	1,2-Dichloroethane
GC/MS	EPA 8260B/C/D	1,2-Dichloroethene (total)
GC/MS	EPA 8260B/C/D	1,2-Dichloropropane
GC/MS	EPA 8260B/C/D	1,2-Dichlorotrifluoroethane (Freon 123)
GC/MS	EPA 8260B/C/D	1,3,5-Trimethylbenzene
GC/MS	EPA 8260B/C/D	1,3-Dichlorobenzene (m-Dichlorobenzene)
GC/MS	EPA 8260B/C/D	1,3-Dichloropropane
GC/MS	EPA 8260B/C/D	1,4-Dichlorobenzene (p-Dichlorobenzene)
GC/MS	EPA 8260B/C/D	1-Chlorohexane
GC/MS	EPA 8260B/C/D	2,2-Dichloropropane
GC/MS	EPA 8260B/C/D	2-Butanone (Methyl ethyl ketone MEK)
GC/MS	EPA 8260B/C/D	2-Chloroethyl vinyl ether
GC/MS	EPA 8260B/C/D	2-Chlorotoluene
GC/MS	EPA 8260B/C/D	2-Hexanone
GC/MS	EPA 8260B/C/D	2-Nitropropane
GC/MS	EPA 8260B/C/D	4-Chlorotoluene
GC/MS	EPA 8260B/C/D	4-Methyl-2-pentanone (MBK)
GC/MS	EPA 8260B/C/D	Acetone
GC/MS	EPA 8260B/C/D	Acetonitrile
GC/MS	EPA 8260B/C/D	Acrolein (Propenal)
GC/MS	EPA 8260B/C/D	Acrylonitrile
GC/MS	EPA 8260B/C/D	Allyl chloride (3-Chloropropene)
GC/MS	EPA 8260B/C/D	Benzene
GC/MS	EPA 8260B/C/D	Benzyl Chloride
GC/MS	EPA 8260B/C/D	Bromobenzene



Solid and Chemical Materials		
Technology	Method	Analyte
GC/MS	EPA 8260B/C/D	Bromochloromethane
GC/MS	EPA 8260B/C/D	Bromodichloromethane
GC/MS	EPA 8260B/C/D	Bromoform
GC/MS	EPA 8260B/C/D	n-Butylbenzene
GC/MS	EPA 8260B/C/D	sec-Butylbenzene
GC/MS	EPA 8260B/C/D	tert-Butylbenzene
GC/MS	EPA 8260B/C/D	Carbon disulfide
GC/MS	EPA 8260B/C/D	Carbon tetrachloride
GC/MS	EPA 8260B/C/D	Chlorobenzene
GC/MS	EPA 8260B/C/D	Chloroethane
GC/MS	EPA 8260B/C/D	Chloroform
GC/MS	EPA 8260B/C/D	Chloroprene
GC/MS	EPA 8260B/C/D	Cyclohexane
GC/MS	EPA 8260B/C/D	Cyclohexanone
GC/MS	EPA 8260B/C/D	cis-1,2-Dichloroethylene
GC/MS	EPA 8260B/C/D	trans-1,2-Dichloroethylene
GC/MS	EPA 8260B/C/D	cis-1,3-Dichloropropene
GC/MS	EPA 8260B/C/D	trans-1,3-Dichloropropylene
GC/MS	EPA 8260B/C/D	cis-1,4-Dichloro-2-butene
GC/MS	EPA 8260B/C/D	trans-1,4-Dichloro-2-butene
GC/MS	EPA 8260B/C/D	Di-isopropylether (DIPE)
GC/MS	EPA 8260B/C/D	Dibromochloromethane
GC/MS	EPA 8260B/C/D	Dibromomethane (Methylene Bromide)
GC/MS	EPA 8260B/C/D	Dichlorodifluoromethane
GC/MS	EPA 8260B/C/D	Diethyl ether
GC/MS	EPA 8260B/C/D; EPA 8260B/C/D SIM	p-Dioxane (1,4-Dioxane)
GC/MS	EPA 8260B/C/D	Ethanol (Ethyl Alcohol)
GC/MS	EPA 8260B/C/D	Ethyl acetate
GC/MS	EPA 8260B/C/D	Ethyl methacrylate
GC/MS	EPA 8260B/C/D	Ethyl tert-butyl alcohol (ETBA)
GC/MS	EPA 8260B/C/D	Ethyl tert-butyl ether (ETBE)
GC/MS	EPA 8260B/C/D	Ethylbenzene
GC/MS	EPA 8260B/C/D	Ethylene Oxide
GC/MS	EPA 8260B/C/D	Hexachlorobutadiene
GC/MS	EPA 8260B/C/D	Hexane
GC/MS	EPA 8260B/C/D	Iodomethane (Methyl iodide)
GC/MS	EPA 8260B/C/D	Isobutyl alcohol (2-Methyl-1-propanol)



Solid and Chemical Materials		
Technology	Method	Analyte
GC/MS	EPA 8260B/C/D	p-Isopropyltoluene
GC/MS	EPA 8260B/C/D	Isopropylbenzene
GC/MS	EPA 8260B/C/D	Methacrylonitrile
GC/MS	EPA 8260B/C/D	Methyl Acetate
GC/MS	EPA 8260B/C/D	Methyl bromide (Bromomethane)
GC/MS	EPA 8260B/C/D	Methyl chloride (Chloromethane)
GC/MS	EPA 8260B/C/D	Methylcyclohexane
GC/MS	EPA 8260B/C/D	Methyl methacrylate
GC/MS	EPA 8260B/C/D	Methyl tert-butyl ether (MTBE)
GC/MS	EPA 8260B/C/D	Methylene chloride
GC/MS	EPA 8260B/C/D	Naphthalene
GC/MS	EPA 8260B/C/D	Pentachloroethane
GC/MS	EPA 8260B/C/D	Propionitrile (Ethyl cyanide)
GC/MS	EPA 8260B/C/D	n-Propylbenzene
GC/MS	EPA 8260B/C/D	Styrene
GC/MS	EPA 8260B/C/D	tert-Amyl alcohol (TAA)
GC/MS	EPA 8260B/C/D	tert-Amyl methyl ether (TAME)
GC/MS	EPA 8260B/C/D	tert-Butyl alcohol (TBA)
GC/MS	EPA 8260B/C/D	tert-Butyl formate (TBF)
GC/MS	EPA 8260B/C/D	Tetrachloroethylene (Perchloroethylene)
GC/MS	EPA 8260B/C/D	Tetrahydrofuran
GC/MS	EPA 8260B/C/D	Toluene
GC/MS	EPA 8260B/C/D	Trichloroethene (Trichloroethylene)
GC/MS	EPA 8260B/C/D	Trichlorofluoromethane
GC/MS	EPA 8260B/C/D	Vinyl acetate
GC/MS	EPA 8260B/C/D	Vinyl chloride
GC/MS	EPA 8260B/C/D	Xylene (total)
GC/MS	EPA 8260B/C/D	m,p-Xylene
GC/MS	EPA 8260B/C/D	o-Xylene
GC/MS	EPA 8260B/C/D	1-Bromopropane
GC/MS	EPA 8260B/C/D	Isopropyl Alcohol
GC/MS	EPA 8260B/C/D	n-Butyl Alcohol
GC/MS	EPA 8270D/E	1,2,4,5-Tetrachlorobenzene
GC/MS	EPA 8270D/E	1,2,4-Trichlorobenzene
GC/MS	EPA 8270D/E	1,2-Dichlorobenzene (o-Dichlorobenzene)
GC/MS	EPA 8270D/E	1,2-Diphenylhydrazine
GC/MS	EPA 8270D/E	1,3,5-Trinitrobenzene (1,3,5-TNB)



Solid and Chemical Materials		
Technology	Method	Analyte
GC/MS	EPA 8270D/E	1,3-Dichlorobenzene (m-Dichlorobenzene)
GC/MS	EPA 8270D/E	1,3-Dinitrobenzene (1,3-DNB)
GC/MS	EPA 8270D/E	1,4-Dichlorobenzene (p-Dichlorobenzene)
GC/MS	EPA 8270D/E	1,4-Naphthoquinone
GC/MS	EPA 8270D/E	1,4-Phenylenediamine
GC/MS	EPA 8270D/E	1-Chloronaphthalene
GC/MS	EPA 8270D/E; EPA 8270D/E SIM	1-Methylnaphthalene
GC/MS	EPA 8270D/E	1-Naphthylamine
GC/MS	EPA 8270D/E	2,3,4,6-Tetrachlorophenol
GC/MS	EPA 8270D/E	2,4,5-Trichlorophenol
GC/MS	EPA 8270D/E	2,4,6-Trichlorophenol
GC/MS	EPA 8270D/E	2,4-Dichlorophenol
GC/MS	EPA 8270D/E	2,4-Dimethylphenol
GC/MS	EPA 8270D/E	2,4-Dinitrophenol
GC/MS	EPA 8270D/E	2,4-Dinitrotoluene (2,4-DNT)
GC/MS	EPA 8270D/E	2,6-Dichlorophenol
GC/MS	EPA 8270D/E	2,6-Dinitrotoluene (2,6-DNT)
GC/MS	EPA 8270D/E	2-Acetylaminofluorene
GC/MS	EPA 8270D/E	2-Chloronaphthalene
GC/MS	EPA 8270D/E	2-Chlorophenol
GC/MS	EPA 8270D/E	2-Methyl-4,6-dinitrophenol (4,6-Dinitro-o-cresol)
GC/MS	EPA 8270D/E; EPA 8270D/E SIM	2-Methylnaphthalene
GC/MS	EPA 8270D/E	2-Methylphenol (o-Cresol)
GC/MS	EPA 8270D/E	2-Naphthylamine
GC/MS	EPA 8270D/E	2-Nitroaniline
GC/MS	EPA 8270D/E	2-Nitrophenol
GC/MS	EPA 8270D/E	2-Picoline (2-Methylpyridine)
GC/MS	EPA 8270D/E	3,3`-Dichlorobenzidine
GC/MS	EPA 8270D/E	3,3`-Dimethylbenzidine
GC/MS	EPA 8270D/E	3-Methylcholanthrene
GC/MS	EPA 8270D/E	3&4-Methylphenol (m,p-Cresol)
GC/MS	EPA 8270D/E	3-Nitroaniline
GC/MS	EPA 8270D/E	4-Aminobiphenyl
GC/MS	EPA 8270D/E	4-Bromophenyl phenyl ether
GC/MS	EPA 8270D/E	4-Chloro-3-methylphenol
GC/MS	EPA 8270D/E	4-Chloroaniline
GC/MS	EPA 8270D/E	4-Chlorophenyl phenylether



Solid and Chemical Materials		
Technology	Method	Analyte
GC/MS	EPA 8270D/E	4-Dimethyl aminoazobenzene
GC/MS	EPA 8270D/E	4-Nitroaniline
GC/MS	EPA 8270D/E	4-Nitrophenol
GC/MS	EPA 8270D/E	5-Nitro-o-toluidine
GC/MS	EPA 8270D/E	7,12-Dimethylbenz(a) anthracene
GC/MS	EPA 8270D/E; EPA 8270D/E SIM	Acenaphthene
GC/MS	EPA 8270D/E; EPA 8270D/E SIM	Acenaphthylene
GC/MS	EPA 8270D/E	Acetophenone
GC/MS	EPA 8270D/E	Aniline
GC/MS	EPA 8270D; EPA 8270D SIM	Anthracene
GC/MS	EPA 8270D/E	Aramite
GC/MS	EPA 8270D/E	Atrazine
GC/MS	EPA 8270D/E	Benzaldehyde
GC/MS	EPA 8270D/E	Benzidine
GC/MS	EPA 8270D/E; EPA 8270D/E SIM	Benzo(a)anthracene
GC/MS	EPA 8270D/E; EPA 8270D/E SIM	Benzo(a)pyrene
GC/MS	EPA 8270D/E; EPA 8270D/E SIM	Benzo(b)fluoranthene
GC/MS	EPA 8270D/E; EPA 8270D/E SIM	Benzo(g,h,i)perylene
GC/MS	EPA 8270D/E; EPA 8270D/E SIM	Benzo(k)fluoranthene
GC/MS	EPA 8270D/E	Benzoic acid
GC/MS	EPA 8270D/E	Benzyl alcohol
GC/MS	EPA 8270D/E	Biphenyl (1,1'-Biphenyl)
GC/MS	EPA 8270D/E	bis(2-Chloroethoxy)methane
GC/MS	EPA 8270D/E	bis(2-Chloroethyl) ether
GC/MS	EPA 8270D/E	bis(2-Chloroisopropyl) ether (2,2'-Oxybis(1-chloropropane))
GC/MS	EPA 8270D/E	bis(2-Ethylhexyl) phthalate (DEHP)
GC/MS	EPA 8270D/E	Butyl benzyl phthalate
GC/MS	EPA 8270D/E	Carbazole
GC/MS	EPA 8270D/E	Caprolactam
GC/MS	EPA 8270D/E	Chlorobenzilate
GC/MS	EPA 8270D/E; EPA 8270D/E SIM	Chrysene
GC/MS	EPA 8270D/E	Diallate
GC/MS	EPA 8270D/E	Dinoseb
GC/MS	EPA 8270D/E	Di-n-butyl phthalate
GC/MS	EPA 8270D/E	Di-n-octyl phthalate
GC/MS	EPA 8270D/E; EPA 8270D/E SIM	Dibenz(a,h)anthracene
GC/MS	EPA 8270D/E	Dibenz(a,j)acridine



Solid and Chemical Materials		
Technology	Method	Analyte
GC/MS	EPA 8270D/E	Dibenzofuran
GC/MS	EPA 8270D/E	Diethyl phthalate
GC/MS	EPA 8270D/E	Dimethyl phthalate
GC/MS	EPA 8270D/E	a,a-Dimethylphenethylamine
GC/MS	EPA 8270D/E	Diphenyl Ether
GC/MS	EPA 8270D/E	p-Dioxane (1,4-Dioxane)
GC/MS	EPA 8270D/E	Ethyl methanesulfonate
GC/MS	EPA 8270D/E; EPA 8270D/E SIM	Fluoranthene
GC/MS	EPA 8270D/E; EPA 8270D/E SIM	Fluorene
GC/MS	EPA 8270D/E	Hexachlorobenzene
GC/MS	EPA 8270D/E	Hexachlorobutadiene
GC/MS	EPA 8270D/E	Hexachlorocyclopentadiene
GC/MS	EPA 8270D/E	Hexachloroethane
GC/MS	EPA 8270D/E	Hexachlorophene
GC/MS	EPA 8270D/E	Hexachloropropene
GC/MS	EPA 8270D/E; EPA 8270D/E SIM	Indeno(1,2,3-cd)pyrene
GC/MS	EPA 8270D/E	Isodrin
GC/MS	EPA 8270D/E	Isophorone
GC/MS	EPA 8270D/E	Isosafrole
GC/MS	EPA 8270D/E	Kepone
GC/MS	EPA 8270D/E	Methapyrilene
GC/MS	EPA 8270D/E	Methyl methanesulfonate
GC/MS	EPA 8270D/E; EPA 8270D/E SIM	Naphthalene
GC/MS	EPA 8270D/E	Nitrobenzene
GC/MS	EPA 8270D/E	Nitroquinoline-1-oxide
GC/MS	EPA 8270D/E	n-Nitroso-di-n-butylamine
GC/MS	EPA 8270D/E	n-Nitrosodi-n-propylamine
GC/MS	EPA 8270D/E	n-Nitrosodiethylamine
GC/MS	EPA 8270D/E	n-Nitrosodimethylamine
GC/MS	EPA 8270D/E	n-Nitrosodiphenylamine
GC/MS	EPA 8270D/E	n-Nitrosodiphenylamine/Diphenylamine (analyte pair)
GC/MS	EPA 8270D/E	n-Nitrosomethylethylamine
GC/MS	EPA 8270D/E	n-Nitrosomorpholine
GC/MS	EPA 8270D/E	n-Nitrosopiperidine
GC/MS	EPA 8270D/E	n-Nitrosopyrrolidine
GC/MS	EPA 8270D/E	Pentachlorobenzene
GC/MS	EPA 8270D/E	Pentachloroethane



Solid and Chemical Materials		
Technology	Method	Analyte
GC/MS	EPA 8270D/E	Pentachloronitrobenzene
GC/MS	EPA 8270D/E; EPA 8270D/E SIM	Pentachlorophenol
GC/MS	EPA 8270D/E	Phenacetin
GC/MS	EPA 8270D/E; EPA 8270D/E SIM	Phenanthrene
GC/MS	EPA 8270D/E	Phenol
GC/MS	EPA 8270D/E	Pronamide (Kerb)
GC/MS	EPA 8270D/E; EPA 8270D/E SIM	Pyrene
GC/MS	EPA 8270D/E	Pyridine
GC/MS	EPA 8270D/E	Safrole
GC/MS	EPA 8270D/E	Simazine
GC/MS	EPA 8270D/E	o-Toluidine
GC/MS	EPA 8270D/E	Dimethoate
GC/MS	EPA 8270D/E	Disulfoton
GC/MS	EPA 8270D/E	Famphur
GC/MS	EPA 8270D/E	Methyl parathion (Parathion methyl)
GC/MS	EPA 8270D/E	Parathion ethyl
GC/MS	EPA 8270D/E	Phorate
GC/MS	EPA 8270D/E	Sulfotepp
GC/MS	EPA 8270D/E	Thionazin (Zinophos)
GC/MS	EPA 8270D/E	O,O,O-Triethyl phosphorothioate
HPLC	EPA 8330A/B	1,3,5-Trinitrobenzene (1,3,5-TNB)
HPLC	EPA 8330A/B	1,3-Dinitrobenzene (1,3-DNB)
HPLC	EPA 8330A/B	2,4,6-Trinitrotoluene (2,4,6-TNT)
HPLC	EPA 8330A/B	2,4-Dinitrotoluene (2,4-DNT)
HPLC	EPA 8330A/B	2,6-Dinitrotoluene (2,6-DNT)
HPLC	EPA 8330A/B	2-Amino-4,6-dinitrotoluene (2-am-dnt)
HPLC	EPA 8330A/B	2-Nitrotoluene
HPLC	EPA 8330A/B	3,5-Dinitroaniline
HPLC	EPA 8330A/B	3-Nitrotoluene
HPLC	EPA 8330A/B	4-Amino-2,6-dinitrotoluene (4-am-dnt)
HPLC	EPA 8330A/B	4-Nitrotoluene
HPLC	EPA 8330A/B	Hexahydro-1,3,5-trinitro-1,3,5-triazine (RDX)
HPLC	EPA 8330A/B	Nitrobenzene
HPLC	EPA 8330A/B	Nitroglycerin
HPLC	EPA 8330A/B	Methyl-2,4,6-trinitrophenylnitramine (Tetryl)



Solid and Chemical Materials		
Technology	Method	Analyte
HPLC	EPA 8330A/B	Octahydro-1,3,5,7-tetranitro-1,3,5,7-tetrazocine (HMX)
HPLC	EPA 8330A/B	Pentaerythritoltetranitrate (PETN)
HPLC	EPA 8330A	2,2',6,6'-Tetranitro-4,4'-azoxytoluene
HPLC	EPA 8330A/B	2-amino-6-Nitrotoluene
HPLC	EPA 8330A/B	4-amino-2-Nitrotoluene
HPLC	EPA 8330A/B	2-amino-4-Nitrotoluene
HPLC	EPA 8330A/B	2,4-diamino-6-Nitrotoluene
HPLC	EPA 8330A/B	2,6-diamino-4-Nitrotoluene
HPLC	EPA 8330A/B	DNX
HPLC	EPA 8330A/B	MNX
HPLC	EPA 8330A/B	TNX
HPLC	EPA 8330A	Nitroguanidine
HPLC	EPA 8330A	Guanidine Nitrate
LC/MS/MS	EPA 6850	Perchlorate
LC/MS/MS	EPA 537 MOD ²	Perfluorobutanoic Acid
LC/MS/MS	EPA 537 MOD ²	Perfluoropentanoic Acid
LC/MS/MS	EPA 537 MOD ²	Perfluorohexanoic Acid
LC/MS/MS	EPA 537 MOD ²	Perfluoroheptanoic Acid
LC/MS/MS	EPA 537 MOD ²	Perfluorooctanoic Acid
LC/MS/MS	EPA 537 MOD ²	Perfluorononanoic Acid
LC/MS/MS	EPA 537 MOD ²	Perfluorodecanoic Acid
LC/MS/MS	EPA 537 MOD ²	Perfluoroundecanoic Acid
LC/MS/MS	EPA 537 MOD ²	Perfluorododecanoic Acid
LC/MS/MS	EPA 537 MOD ²	Perfluorotridecanoic Acid
LC/MS/MS	EPA 537 MOD ²	Perfluorotetradecanoic Acid
LC/MS/MS	EPA 537 MOD ²	Perfluorononanesulfonic Acid
LC/MS/MS	EPA 537 MOD ²	Perfluorobutanesulfonic Acid
LC/MS/MS	EPA 537 MOD ²	Perfluorohexanesulfonic Acid
LC/MS/MS	EPA 537 MOD ²	Perfluorooctanesulfonic Acid
LC/MS/MS	EPA 537 MOD ²	Perfluorodecanesulfonic Acid
LC/MS/MS	EPA 537 MOD ²	Perfluoropentanesulfonic Acid
LC/MS/MS	EPA 537 MOD ²	Perfluoroheptanesulfonic acid
LC/MS/MS	EPA 537 MOD ²	Perfluorooctane sulfonamide
LC/MS/MS	EPA 537 MOD ²	N-Methyl perfluorooctane sulfonamide
LC/MS/MS	EPA 537 MOD ²	N-Ethyl perfluorooctane sulfonamide
LC/MS/MS	EPA 537 MOD ²	Perfluoro-1-octanesulfonamidoacetic acid



Solid and Chemical Materials		
Technology	Method	Analyte
LC/MS/MS	EPA 537 MOD ²	N-Methyl perfluorooctanesulfonamidoacetic acid
LC/MS/MS	EPA 537 MOD ²	N-Ethyl perfluorooctanesulfonamidoacetic acid
LC/MS/MS	EPA 537 MOD ²	N-Methyl perfluorooctane sulfonamidoethanol
LC/MS/MS	EPA 537 MOD ²	4:2 Fluorotelomer Sulfonate
LC/MS/MS	EPA 537 MOD ²	N-Ethyl perfluorooctane sulfonamidoethanol
LC/MS/MS	EPA 537 MOD ²	6:2 Fluorotelomer Sulfonate
LC/MS/MS	EPA 537 MOD ²	8:2 Fluorotelomer Sulfonate
LC/MS/MS	PFAS by LCMSMS Compliant with QSM 5.3 Table B-15	Perfluorobutanoic Acid (PFBA)
LC/MS/MS	PFAS by LCMSMS Compliant with QSM 5.3 Table B-15	Perfluoropentanoic Acid (PFPeA)
LC/MS/MS	PFAS by LCMSMS Compliant with QSM 5.3 Table B-15	Perfluorohexanoic Acid (PFHxA)
LC/MS/MS	PFAS by LCMSMS Compliant with QSM 5.3 Table B-15	Perfluoroheptanoic Acid (PFHpA)
LC/MS/MS	PFAS by LCMSMS Compliant with QSM 5.3 Table B-15	Perfluorooctanoic Acid (PFOA)
LC/MS/MS	PFAS by LCMSMS Compliant with QSM 5.3 Table B-15	Perfluorononanoic Acid (PFNA)
LC/MS/MS	PFAS by LCMSMS Compliant with QSM 5.3 Table B-15	Perfluorodecanoic Acid (PFDA)
LC/MS/MS	PFAS by LCMSMS Compliant with QSM 5.3 Table B-15	Perfluoroundecanoic Acid (PFUnA)
LC/MS/MS	PFAS by LCMSMS Compliant with QSM 5.3 Table B-15	Perfluorododecanoic Acid (PFDoA)
LC/MS/MS	PFAS by LCMSMS Compliant with QSM 5.3 Table B-15	Perfluorotridecanoic Acid (PFTTrDA)
LC/MS/MS	PFAS by LCMSMS Compliant with QSM 5.3 Table B-15	Perfluorotetradecanoic Acid (PFTA)
LC/MS/MS	PFAS by LCMSMS Compliant with QSM 5.3 Table B-15	Perfluorobutanesulfonic Acid (PFBS)
LC/MS/MS	PFAS by LCMSMS Compliant with QSM 5.3 Table B-15	Perfluorohexanesulfonic Acid (PFHxS)
LC/MS/MS	PFAS by LCMSMS Compliant with QSM 5.3 Table B-15	Perfluorooctanesulfonic Acid (PFOS)
LC/MS/MS	PFAS by LCMSMS Compliant with QSM 5.3 Table B-15	Perfluorononanesulfonic Acid (PFNS)
LC/MS/MS	PFAS by LCMSMS Compliant with QSM 5.3 Table B-15	Perfluorodecanesulfonic Acid (PFDS)

Solid and Chemical Materials		
Technology	Method	Analyte
LC/MS/MS	PFAS by LCMSMS Compliant with QSM 5.3 Table B-15	Perfluoroheptanesulfonic acid(PFHpS)
LC/MS/MS	PFAS by LCMSMS Compliant with QSM 5.3 Table B-15	Perfluoropentanesulfonic Acid(PFPeS)
LC/MS/MS	PFAS by LCMSMS Compliant with QSM 5.3 Table B-15	Perfluorooctane sulfonamide (PFOSA)
LC/MS/MS	PFAS by LCMSMS Compliant with QSM 5.3 Table B-15	N-Methyl perfluorooctanesulfonamidoacetic acid (MeFOSAA)
LC/MS/MS	PFAS by LCMSMS Compliant with QSM 5.3 Table B-15	N-Ethyl perfluorooctanesulfonamidoacetic acid (EtFOSAA)
LC/MS/MS	PFAS by LCMSMS Compliant with QSM 5.3 Table B-15	4:2 Fluorotelomer Sulfonate (FTS 4:2)
LC/MS/MS	PFAS by LCMSMS Compliant with QSM 5.3 Table B-15	6:2 Fluorotelomer Sulfonate(FTS 6:2)
LC/MS/MS	PFAS by LCMSMS Compliant with QSM 5.3 Table B-15	8:2 Fluorotelomer Sulfonate (FTS 8:2)
LC/MS/MS	PFAS by LCMSMS Compliant with QSM 5.3 Table B-15	ADONA
LC/MS/MS	PFAS by LCMSMS Compliant with QSM 5.3 Table B-15	2,3,3,3-Tetrafluoro-2-(heptafluoropropoxy)propanoic acid (HFPO-DA; GenX)
LC/MS/MS	PFAS by LCMSMS Compliant with QSM 5.3 Table B-15	11-Chloroeicosafluoro-3-oxaundecane-1-sulfonic acid (11Cl-PF3OUdS; F53B minor)
LC/MS/MS	PFAS by LCMSMS Compliant with QSM 5.3 Table B-15	9-Chlorohexadecafluoro-3-oxanone-1-sulfonic acid (9Cl-PF3ONS; F53B major)
ICP	EPA 6010C/D	Aluminum
ICP	EPA 6010C/D	Antimony
ICP	EPA 6010C/D	Arsenic
ICP	EPA 6010C/D	Barium
ICP	EPA 6010C/D	Beryllium
ICP	EPA 6010C/D	Cadmium
ICP	EPA 6010C/D	Calcium
ICP	EPA 6010C/D	Chromium
ICP	EPA 6010C/D	Cobalt
ICP	EPA 6010C/D	Copper
ICP	EPA 6010C/D	Iron
ICP	EPA 6010C/D	Lead
ICP	EPA 6010C/D	Magnesium
ICP	EPA 6010C/D	Manganese



Solid and Chemical Materials		
Technology	Method	Analyte
ICP	EPA 6010C/D	Molybdenum
ICP	EPA 6010C/D	Nickel
ICP	EPA 6010C/D	Potassium
ICP	EPA 6010C/D	Selenium
ICP	EPA 6010C/D	Silver
ICP	EPA 6010C/D	Sodium
ICP	EPA 6010C/D	Strontium
ICP	EPA 6010C/D	Thallium
ICP	EPA 6010C/D	Tin
ICP	EPA 6010C/D	Titanium
ICP	EPA 6010C/D	Vanadium
ICP	EPA 6010C/D	Zinc
ICP/MS	EPA 6020A/B	Aluminum
ICP/MS	EPA 6020A/B	Antimony
ICP/MS	EPA 6020A/B	Arsenic
ICP/MS	EPA 6020A/B	Barium
ICP/MS	EPA 6020A/B	Beryllium
ICP/MS	EPA 6020A/B	Cadmium
ICP/MS	EPA 6020A/B	Calcium
ICP/MS	EPA 6020A/B	Chromium
ICP/MS	EPA 6020A/B	Cobalt
ICP/MS	EPA 6020A/B	Copper
ICP/MS	EPA 6020A/B	Iron
ICP/MS	EPA 6020A/B	Lead
ICP/MS	EPA 6020A/B	Magnesium
ICP/MS	EPA 6020A/B	Manganese
ICP/MS	EPA 6020A/B	Molybdenum
ICP/MS	EPA 6020A/B	Nickel
ICP/MS	EPA 6020A/B	Potassium
ICP/MS	EPA 6020A/B	Selenium
ICP/MS	EPA 6020A/B	Silver
ICP/MS	EPA 6020A/B	Sodium
ICP/MS	EPA 6020A/B	Strontium
ICP/MS	EPA 6020A/B	Thallium
ICP/MS	EPA 6020A/B	Tin
ICP/MS	EPA 6020A/B	Titanium



Solid and Chemical Materials		
Technology	Method	Analyte
ICP/MS	EPA 6020A/B	Vanadium
ICP/MS	EPA 6020A/B	Zinc
CVAA	EPA 7471B	Mercury
UV/VIS	EPA 7196A	Hexavalent Chromium (Cr6+)
UV/VIS	EPA 9012B	Cyanide (Total)
IC	EPA 9056A	Bromide
IC	EPA 9056A	Chloride
IC	EPA 9056A	Fluoride
IC	EPA 9056A	Nitrate
IC	EPA 9056A	Nitrite
IC	EPA 9056A	Sulfate
IC	EPA 9056A	Total nitrate-nitrite
Gravimetric Methods	SM 2540G	% solids
Electrometric Methods	EPA 9045D	Hydrogen Ion (pH)
Ignitability	EPA 1010A MOD	Flash Point
Ignitability	EPA 1020B MOD	Flash Point
Waste Characterization	EPA Ch.7	Reactive Cyanide and Reactive Sulfide
Waste Characterization	EPA Section 7.3	Reactive Cyanide
Waste Characterization	EPA Section 7.3	Reactive Sulfide
Preparation	Method	Type
Organics Preparation	EPA 3510C	Separatory Funnel Liquid-Liquid Extraction; Leachates
TCLP Preparation	EPA 1311	Toxicity Characteristic Leaching Procedure
SPLP Preparation	EPA 1312	Synthetic Precipitation Leaching Procedure
Organics Preparation	EPA 8011	Microextraction
Organics Preparation	EPA 3546	Microwave Extraction
Organics Preparation	EPA 3550C	Ultrasonic Extraction
Organics Preparation	EPA 3580A	Waste Dilution for Extractable Organics
Organics Preparation	EPA 8330A; EPA 8332	Ultrasonic Extraction
Organics Preparation	EPA 8330B	Shaker Table Extraction
Volatile Organics Preparation	EPA 3585	Waste Dilution for Volatile Organics
Volatile Organics Preparation	EPA 5030A	Closed System Purge and Trap; Bulk Soils
Volatile Organics Preparation	EPA 5030B	Closed System Purge and Trap; Leachates and Methanol Extracts
Volatile Organics Preparation	EPA 5035; EPA 5035A	Closed System Purge and Trap



Solid and Chemical Materials		
Technology	Method	Analyte
Organics Cleanup	EPA 3660B	Sulfur Cleanup
Organics Cleanup	EPA 3665A	Sulfuric Acid Cleanup
Lachat MicroDistillation	EPA 9012B	Cyanide MicroDistillation; proprietary method
Inorganic Preparation	EPA 3010A	Metals Acid Digestion by Hotblock; Leachates
Inorganic Preparation	EPA 3050B	Metals Acid Digestion by Hotblock
Inorganic Preparation	EPA 3060A	Alkaline Digestion, Cr6+
Inorganic Preparation	EPA 7470A	CVAA Digestion by Hotblock; Leachates
Inorganic Preparation	EPA 7471B	CVAA Digestion by Hotblock

Note:

- 1. This scope is formatted as part of a single document including Certificate of Accreditation No. L2229
- 2. Not compliant with QSM V5.3Table B-15



Vice President

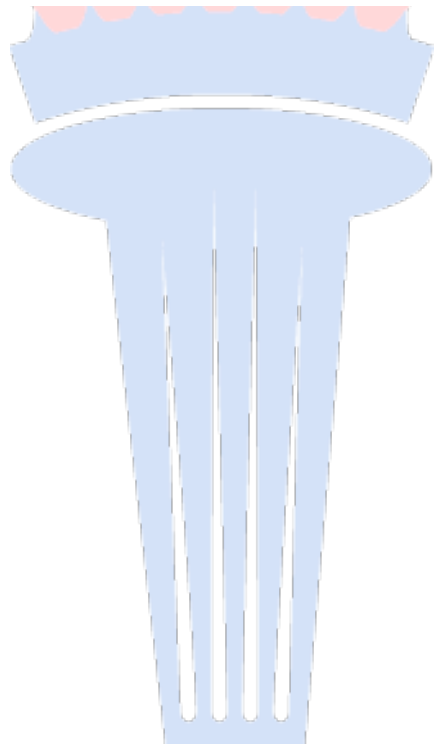

ATTACHMENT F

Responses to Comments on the Draft QAPP

Responses to Comments submitted by the Central Coast Regional Water Quality Control Board¹

COMMENT 1: Table 1, Summary of Existing Monitoring Wells and Samples Collected Annually:

COMMENT 1a: Add the units (e.g. feet) to the Average Well Depth column heading.

RESPONSE TO COMMENT 1a: *The table was revised per the comment.*

COMMENT 1b: Add a footnote to indicate the owners of the five wells in the OUCTP Lower 180-Foot Aquifer that are not Army owned. Additionally, update Worksheet #17c3 and Figure 12 to indicate the wells that are not Army owned and note the well owners.

RESPONSE TO COMMENT 1b: *Table 1 and Figure 12 were revised per the comment. Worksheet #17c3 is for the OUCTP A-Aquifer and all the wells listed are Army-owned. Worksheet #17c5 is for the OUCTP Lower 180-Foot Aquifer and was revised per the comment.*

COMMENT 1c: Please confirm the total number of samples collected annually for the OUCTP Area. The total is listed as 336 however the number of annual samples collected from each aquifer adds up to 335.

RESPONSE TO COMMENT 1c: *The table was revised from 336 to 335 per the comment.*

COMMENT 1d: Please confirm that the number of wells listed in Table 1, the wells shown on Figures 2, 5, 6, 9, 11, and 12 and the wells listed in the respective Worksheet #17c for each area are consistent as the number and names of wells vary between the table, figures, and worksheets. For example, well MW-OU2-05-AR is listed in Worksheet #17c2 but is not shown on Figure 6 and well MW-OU2-07A is shown on Figure 6 but is not listed in Worksheet #17c2. In some cases, the variation in the number of wells in Table 1 versus those listed in Worksheet #17c and shown on Figures 2, 5, 6, 9, 11, and 12 may be due to wells with multi-level monitoring; however, it appears that this may not always be the case.

RESPONSE TO COMMENT 1d:

A detailed comparison of the figures, text (Worksheet 17), and Table 1 was conducted to ensure consistency between document elements and revisions were made where needed. MW-OU2-05-AR is the replacement well for MW-OU2-05-A. This well has not been surveyed due to construction, but the approximate location of this well was added to the figure. MW-OU2-07A was added to the text.

COMMENT 2: Worksheet #17c1, Sites 2/12 GWMP:

COMMENT 2a: The Draft QAPP indicates that well EW-12-06-180 is sampled quarterly; however, the *Final 2020 Sites 2/12 Annual Groundwater and Soil Gas Monitoring and Treatment System Report* indicates that this well is not sampled or measured for depth to water due to a pump failure in 2018 and that nearby wells provide enough data. As appropriate, please either remove this well from Worksheet

¹ In a letter dated August 12, 2021 (see Administrative Record No. [BW-2785M.2](#)). The comments are reproduced here as provided to the U.S. Department of the Army (Army) and there have been no changes to spelling, grammar, or punctuation.

#17c1 or add a footnote to clarify that this well is not sampled or measured for water levels due to pump failure.

RESPONSE TO COMMENT 2a: *The information provided in the referenced report is correct; therefore, EW-12-06-180 was removed from Worksheet #17c1 per the comment.*